

# Power Transmission Engineering®

AUGUST 2019

## COUPLINGS

REDUCE DOWNTIME

**SOFTWARE**

**PACKAGING**

[www.powertransmission.com](http://www.powertransmission.com)

SEE OUR  
AD INSIDE

**brother**  
at your side

[BrotherGearmotors.com](http://BrotherGearmotors.com)



# PROTECT YOUR PRODUCTIVITY WITH THE INDUSTRY'S BEST GEARMOTOR WARRANTY.



Brother Gearmotor delivers the ultimate peace of mind by introducing our quality 5 year limited warranty on our full line of standard products.

A full range of gearmotors for whatever your needs may be:



Low Cost



Energy Efficient



Precise

**brother**  
at your side

Call us today for a sample gearmotor to try out.

866.523.6283  
BrotherGearmotors.com

# Power Transmission Engineering®

AUGUST 2019

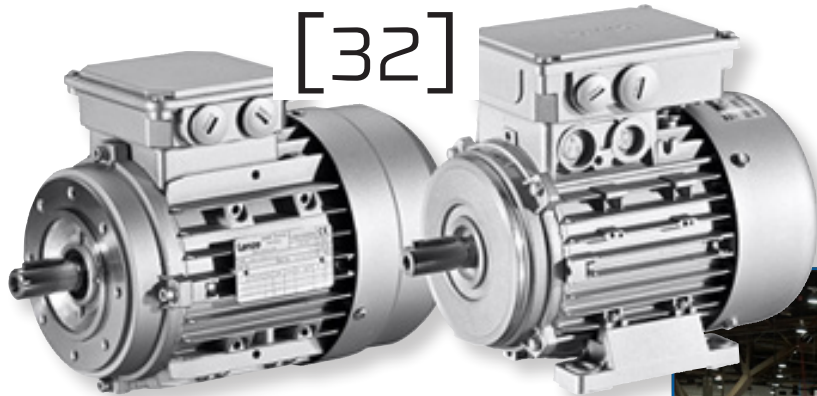

[36]



## FEATURE ARTICLES

- [22] **KISSsoft Makes it Possible to Analyze Contact Patterns for UAV Helicopter Transmissions in Prototype Trials**  
Checking microgeometry of bevel gears at the design stage.
- [26] **Using Couplings to Reduce Downtime**  
To maintain machinery, planned downtime is necessary. To fix broken equipment, unplanned downtime is excruciating, especially when your factory is running closer and closer to full capacity.
- [32] **All the Small Things**  
Packaging and material handling applications are reaping the benefits of smaller, smarter and more efficient components.
- [36] **Adapt, Embrace and Innovate at Pack Expo 2019**  
Pack Expo Las Vegas (Sept. 23–25) showcases the latest packaging technologies to help manufacturers improve operations and stay competitive.

## TECHNICAL ARTICLES

- [42] **Lubrication of Plastic Worm Gears**  
In the selection of lubricating greases for plastic worm gears, the user needs to know the influence of each grease constituent on the tribological performance in order to choose the appropriate lubricant.
- [48] **CFD Simulation of Geared Transmissions with Injection Lubrication**  
In this study, a finite volume CFD simulation model of a single-stage injection-lubricated test gearbox was applied to investigate its oil flow and no-load power loss. The results provide physically plausible information on the oil supply and its distribution.

Vol. 13, No. 5. POWER TRANSMISSION ENGINEERING (ISSN 2331-2483) is published monthly except in January, May, July and November by Randall Publications LLC, 1840 Jarvis Ave., Elk Grove Village, IL 60007, (847) 437-6604. Cover price \$7.00. U.S. Periodicals Postage Paid at Elk Grove Village IL and at additional mailing offices. Send address changes to POWER TRANSMISSION ENGINEERING, 1840 Jarvis Ave., Elk Grove Village, IL 60007.

Randall Publications LLC makes every effort to ensure that the processes described in POWER TRANSMISSION ENGINEERING conform to sound engineering practice. Neither the authors nor the publisher can be held responsible for injuries sustained while following the procedures described. Postmaster: Send address changes to POWER TRANSMISSION ENGINEERING, 1840 Jarvis Avenue, Elk Grove Village, IL, 60007. ©2019 Contents copyrighted by RANDALL PUBLICATIONS, LLC. No part of this publication may be reproduced or transmitted in any form or by any means, electronic or mechanical, including photocopying, recording, or by any information storage and retrieval system, without permission in writing from the publisher. Contents of ads are subject to Publisher's approval.

**KYODO YUSHI**

CONTACT US **INFO@KYODOYUSHIUSA.COM**

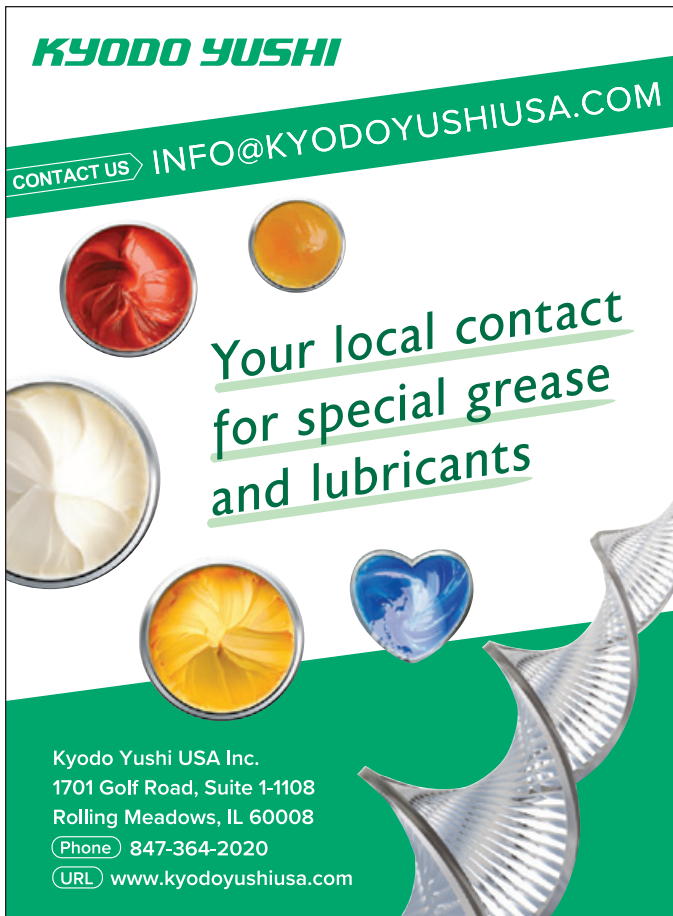

**Your local contact  
for special grease  
and lubricants**

Kyodo Yushi USA Inc.  
1701 Golf Road, Suite 1-1108  
Rolling Meadows, IL 60008  
Phone 847-364-2020  
URL [www.kyodoyushiusa.com](http://www.kyodoyushiusa.com)

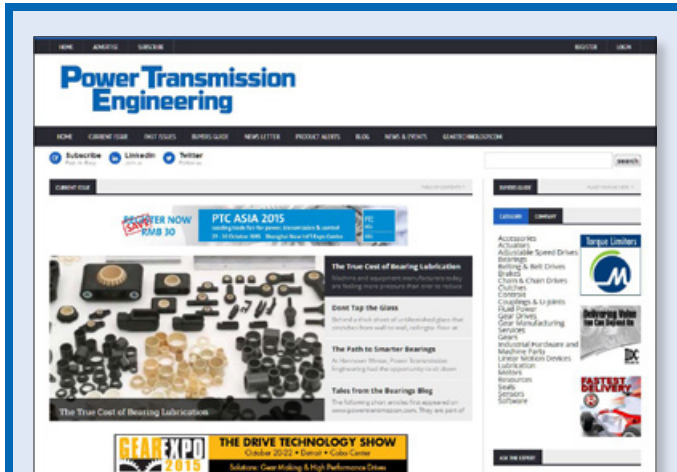

**Power Transmission Engineering**

Subscribe | LinkedIn | Twitter

Current Issue

**PTC ASIA 2015**  
The 12th Annual Asia-Pacific Tribology Conference & Exhibition, Singapore, Singapore, 10-12 November 2015

**The True Cost of Bearing Lubrication**  
Lubrication and equipment manufacturers are looking for ways to reduce the true cost of bearing lubrication.

**Don't Tap the Glass**  
Several years ago, a general contractor and plant manager from a well-known, leading steel mill, an industry leader in the steel industry, was asked to provide a bearing solution for a large industrial machine.

**The Path to Smarter Bearings**  
A Maximum Review, Power Transmission Engineering has the opportunity to visit the factory floor of a leading bearing manufacturer.

**Takes from the Bearings Blog**  
The following short articles first appeared on [www.powertransmission.com](http://www.powertransmission.com). They are part of

**THE DRIVE TECHNOLOGY SHOW**  
October 22-23 • Detroit • Cobo Center  
Sponsors: GearWiring & High Performance Drive

## Power Transmission Engineering

- Technical content free for everyone
- Comprehensive Buyers Guide
- The latest news

[www.powertransmission.com](http://www.powertransmission.com)

# Power Transmission Engineering

VOL. 13, NO. 5

- [04] **PTEExtras**  
Direct Drive Motor Technology and Air Bearings.
- [06] **Publisher's Page**  
Invitation.
- [08] **Product News**  
**Magnadrive** provides no-contact solution for rotating equipment; **ABB** launches safety mount spherical roller bearings; **Bosch Rexroth** offers compact hydraulic solution.
- [39] **Engineering sMART**  
Products and services marketplace.
- [56] **Industry News**  
**NORD** delivers IIoT, new technologies and system efficiency; **Forest City Gear** adds to team; **Napoleon Engineering Services** achieves NADCAP.
- [61] **Calendar**  
**Sept. 9–13:** AGMA Basic Training for Gear Manufacturing, Chicago.  
**Oct. 7–10:** Gear Dynamics and Gear Noise Short Course, Ohio State University.  
**Oct 15–17:** Motion + Power Technology Expo, Detroit.
- [62] **Advertiser Index**  
Contact information for every advertiser in this issue.
- [64] **Power Play**  
**Renewable Building Blocks**  
LEGO & Vestas Collaborate on Sustainability Project.



Cover photo courtesy of Flender Corp.



---

# Make your life easier by choosing the right coupling

Dodge® Raptor tire coupling was created with industrial users in mind. The innovative elastomeric element has higher bond strength, more resistance to fatigue, and longer life than competitive urethane designs. The split element leads to simpler maintenance, and the slotted clamp ring holes result in easier installation. The Raptor was designed for a broad range of industrial applications and is available for hazardous and extreme environments.

**Easier installation. Increased reliability. Longer life.**

Dodge Raptor couplings

479.646.4711  
baldor.abb.com



[www.powertransmission.com](http://www.powertransmission.com)

# COMPLETE DRIVE SYSTEMS & SUPPORT

## 25% OF ALL ORDERS SHIP IN 24 HRS



**REGISTER FOR ONLINE ORDERING:**  
**BENEFITS.MYNORD.COM**  
**888-314-6673**



### Editor's Choice

#### Six Latest Trends in Direct Drive Motor Technology

Despite the maturity of the machine tool industry, allowing for many advancements in engineering design over the span of decades, a machine is still limited by what the builder is able to implement. One of the most important choices builders make in the development stages of a machining platform is which type of motor to use. Learn more here:

[www.powertransmission.com/blog/the-6-latest-trends-in-direct-drive-motor-technology/](http://www.powertransmission.com/blog/the-6-latest-trends-in-direct-drive-motor-technology/)



### Event Spotlight: Process Expo 2019

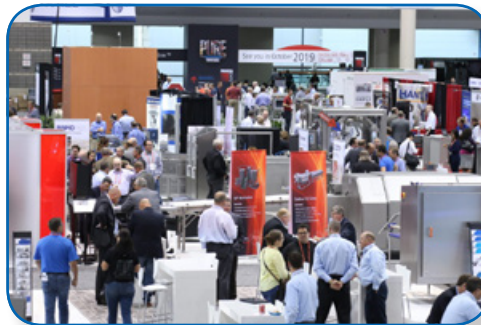

Process Expo represents the pinnacle of food technology bringing together the world's most successful food and beverage processors, equipment manufacturers and leaders in the field of academia. It is owned and organized by the Food Processing Suppliers Association (FPSA), a global

trade association serving suppliers in the food and beverage industries. Learn more here:

[www.powertransmission.com/news/8012/2017-Process-Expo-/](http://www.powertransmission.com/news/8012/2017-Process-Expo-/)

### PTE Videos PI Air Bearings and Rotation Stages

*Rotary air bearings provide high precision motion with minimal eccentricity and wobble. PI rotary air bearings provide extremely small radial runout errors, excellent velocity smoothness and high stiffness. Learn more here:*

[www.powertransmission.com/videos/PI-Offers-Rotary-Air-Bearings-and-Rotation-Stages-/](http://www.powertransmission.com/videos/PI-Offers-Rotary-Air-Bearings-and-Rotation-Stages-/)



### Stay Connected



Follow us on Twitter  
[twitter.com/#!/PowerTransMag](https://twitter.com/#!/PowerTransMag)



Connect with us on LinkedIn  
[www.linkedin.com/groups/Power-Transmission-Engineering-PTE-2950055](https://www.linkedin.com/groups/Power-Transmission-Engineering-PTE-2950055)



Subscribe Online  
[www.powertransmission.com/subscribe.htm](http://www.powertransmission.com/subscribe.htm)



# BEARING SOLUTIONS FOR HEAVY DUTY APPLICATIONS.



AXPB RBtech provides dependable bearing solutions for extreme industrial applications from Steel Mills to Construction Machinery. Faster lead times, an expanding product line and a fast growing arsenal of state-of-the-art manufacturing facilities have positioned AXPB RBtech as a performance alternative to top tier bearing manufacturers.

- Spherical Roller Bearings
- Cylindrical Roller Bearings
- Tapered Roller Bearings
- Angular Contact Ball Bearings
- Sheave Bearings
- Gear/Bearing Assemblies

**DISCOVER THE AXPB RBTECH DIFFERENCE.**

For more information call 1-800-708-2128 or visit [www.rbibearing.com/axpb-rbtech](http://www.rbibearing.com/axpb-rbtech)

# Invitation

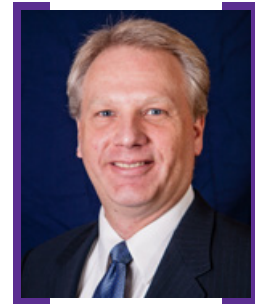

I'd like to invite you to come visit us at **Motion+Power Technology Expo**. The show takes place in October at Cobo Center in Detroit, and we'll be there in booth #3826.

For those of you who specify, buy, use and maintain mechanical power transmission equipment—you know, things like gears, bearings, couplings, fluid power, electric motors, and so on—the show is becoming more relevant to you.

At our booth, you can take part in "Ask the Expert LIVE!" As a member of the audience, you can ask questions of our experts and get answers right there. We have four sessions this year, and we've lined up technical experts from some of the leading companies in each field:

- Gear Manufacturing (Tuesday, Oct. 15, 10:30 a.m.)
- Gear Design (Tuesday, Oct. 15, 2:30 p.m.)
- Lubrication (Wednesday, Oct. 16, 10:30 a.m.)
- Bearings (Wednesday, Oct. 16, 2:30 p.m.)

We'd love to see you there, but if you can't make it, you can still participate. Send your questions in advance to our Senior Editor, Jack McGuinn ([jmcguinn@powertransmission.com](mailto:jmcguinn@powertransmission.com)), and we'll ask the questions for you. Then, you can watch the recorded sessions on *Power Transmission Engineering TV* ([www.powertransmission.com/tv](http://www.powertransmission.com/tv)).

Next issue, we'll have even more information about the show, including booth previews from some of the leading suppliers of mechanical power transmission components who will be exhibiting there (companies like ABA-PGT, Ancon Gear, ASI Technologies, Bevel Gears India, Brellie Gear, Capstan Atlantic, CGI Inc., Cincinnati Gearing Systems, Columbia Gear, Dana-Fairfield Mfg., Dana-Graziano

Transmission, Dayton Gear & Tool, Delta Gear, Great Taiwan Gear, Innovative Rack & Gear, Linamar Corp., Meritor Inc., Omni Gear & Machine, Perry Technology, Philadelphia Gear, Precipart, Rave Gears, Raycar Gear & Machine, Riley Gear Corporation, STD Precision Gear & Instrument, Toledo Gearmotor, Trojon Gear, United Gear & Assembly, ZKL Bearings and many more). Stay tuned for the next issue or visit [motionpowerexpo.com](http://motionpowerexpo.com) to learn more.

Now is the time to make your plans to attend. To make it easier, our friends at the American Gear Manufacturers Association have provided us with this free pass to get you into the show. Register today, and we hope to see you there.

#### OFFICIAL SHOW HOURS

**Tuesday, October 15**  
9:00 am – 6:00 pm

**Wednesday, October 16**  
9:00 am – 5:00 pm

**Thursday, October 17**  
9:00 am – 4:00 pm

#### HOW TO REGISTER

##### ONLINE

Visit [MotionPowerExpo.com](http://MotionPowerExpo.com) and enter your guest pass registration code (at right) to pre-register for an expo-only admission.

##### OR

##### IN PERSON

Present this pass at the Motion + Power Technology Expo registration counter in the Cobo Center. This guest pass saves you \$50 in on-site registration fees.

When issued by an exhibitor at Motion + Power Technology Expo, this Guest Pass entitles the bearer to one complimentary expo-only admission, good during the official show hours.



**MOTION+POWER**  
TECHNOLOGY EXPO

# FREE GUEST PASS

**GEAR. ELECTRIC. FLUID POWER. ALL UNDER ONE ROOF.**

▶▶▶▶ MOVING THE FUTURE.

**COURTESY OF:** Gear Technology and Power Transmission Engineering Magazines

**BOOTH #:** 3826

**GUEST PASS REGISTRATION CODE:** MEX210

With the latest demands for efficiency and power density, often the solution is a choice combining power transmission technologies. At MPT Expo, you'll see the entire power transmission supply chain—with mechanical, fluid power, electric, and hybrid solutions.



Owned by: American Gear Manufacturers Association

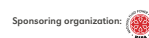

Sponsoring organization:



Co-located with: HHS

**OCTOBER 15-17, 2019** | DETROIT, MICHIGAN | COBO CENTER | [MotionPowerExpo.com](http://MotionPowerExpo.com)



**THE COUPLING.**

**FOR THE HIGHEST LEVEL  
OF PRECISION**

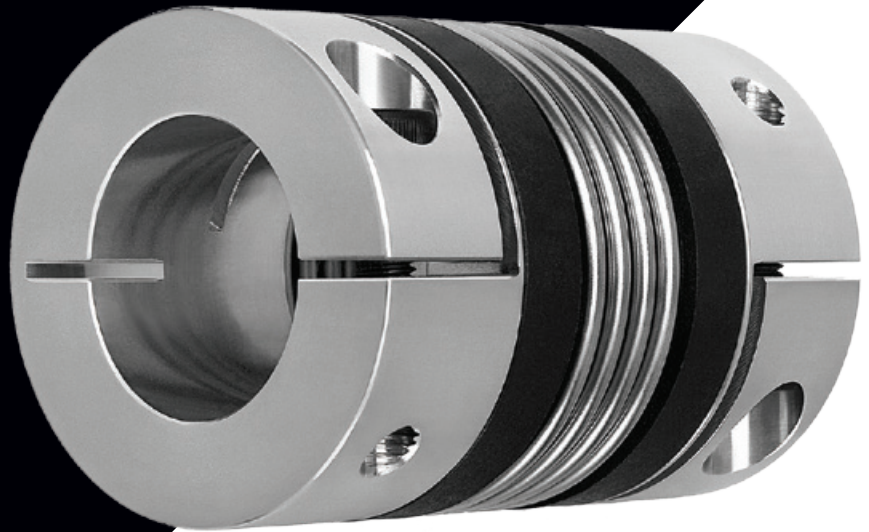

**BK**

**BELLOWS COUPLINGS**

[RW-AMERICA.COM](http://RW-AMERICA.COM)

**R+W**<sup>®</sup>  
A POPPE + POTTHOFF COMPANY

# MagnaDrive Synchra Series

PROVIDES NO-CONTACT SOLUTION FOR ROTATING EQUIPMENT

MATTHEW JASTER, SENIOR EDITOR

Trouble-shooting often leads to product development. This was the case when MagnaDrive (Woodinville, Washington) was approached by several customers to help prevent downtime in various machining operations. In previous circumstances, the couplings, bearings, and motors were failing prematurely due to vibration, heat generation and strong attraction forces.

“One customer application involving elastomeric couplings only lasted around two months before they needed to be replaced,” said Jake Lee, global CTO, at MagnaDrive Corporation. “So two years ago, we began to develop a solution where our disc-style couplings could handle higher horsepower, but not cause any axial forces on the motor or load shafts.”

The MagnaDrive Synchra couplings (patented May 28, 2019) harness the power of a no-contact, magnet-to-magnet synchronous connection for all types of rotating equipment. Compact and tough, the interior magnet rotors of this patented design uses Neodymium-Iron-Boron magnets—the strongest permanent magnets in the world.

The Synchra Series maximizes torque while eliminating any magnetic slip, resulting in consistent performance for vital equipment, with zero rpm’s lost. These couplings are much lighter, and in many cases, half the weight of magnet-to-copper type couplings. They can be used on high-speed applications more often than the magnet-to-copper type.

“We basically developed the Synchra series to reduce the size and the heat generation of our traditional magnet couplings and provide an opportunity to handle a larger range of horsepower,” said Geoff Harmon, senior applications engineer at MagnaDrive. “The Synchra has no physical contact between the motor shaft and the load shaft. It creates very large torque in a very compact design. It has a much higher torque to weight ratio than other magnetic couplings.”

The end game is a magnetic coupling designed for lifetime operation; a nice change of pace for customer’s switching out components every couple of months and shutting down production lines for maintenance and reliability concerns.

## A History of Magnetic Force

MagnaDrive’s original patented technology uses high power magnets to create an induced electromotive force used for torque transfer. The system physically separates the two elements of the motor system, placing magnet discs on the load shaft and a conductor assembly on the motor shaft. Motor torque is transferred to the load across an air gap. Varying the air gap between the magnets and conductor changes the strength of the magnetic field and hence controls output speed. A portfolio of 20 domestic and more than 200 foreign patents protects this technology.

This includes disconnected torque-transfer technology that reduces maintenance and operating costs, increasing process availability, and improves system reliability. This



technology is demonstrating substantially reduced energy requirements associated with the operation of a vast base of motors that drive pumps, fans, blowers and other processing and manufacturing equipment used in industry.

Early funding for MagnaDrive was supplied by a grant from the U.S. Department of Energy (DOE). Also, DOE testing demonstrated that MagnaDrive’s products reduce energy usage by up to 70 percent. The DOE operates several units in mission critical applications at nuclear facilities. The U.S. Navy and U.S. Air Force also utilize MagnaDrive’s technology.

The Synchra series was developed as an evolving piece of technology to handle certain critical applications where other couplings were failing prematurely or causing production downtime.

## Application Examples

Due to the Synchra’s ability to handle critical applications, MagnaDrive offered the coupling to a hospital where a customer was having serious vibration and thermal growth issues with a small pump shaft. The Synchra was the best selection for this due to its reliability.

“Most of these applications are critical, so it’s really important to use equipment that doesn’t shut down for maintenance or doesn’t need to be rebuilt or any other problems,”



## ***OFFSET SHAFTS. SOLVED.***

Offset Couplings from Zero-Max reduce space requirements for parallel offset shafts in large system applications. These specialized couplings provide machine designers with an important option for reducing overall machine size and footprint.

Compact in design, Schmidt Offset Couplings transmit constant angular velocity and torque in a wide range of parallel shaft misalignments. Handling high amounts of parallel offset up to 9 inches, they are available with torque capacities up to 459,000 in-lbs.

Schmidt Offset Couplings can be mounted to shaft hubs or directly to existing machine flanges. They are available for shaft displacements of 0.156 inches to 17.29 inches and torque capacities from 55 to 459,000 inch-pounds. Many design configurations are available including specials.



[www.zero-max.com](http://www.zero-max.com) 800.533.1731

**////// ZERO-MAX®**

Harmon said. “If they can install components that just run over a lifetime, they’ll be much better off long-term regarding efficiency and reliability.”

In this application, the Synchra coupling reduced most of the vibration and solved the misalignment issues that had occurred with previously-installed radial couplings. Although this coupling is heavier than a standard coupling, the bearing can handle the added weight. “The weight was not the issue,” Lee said. “The issue was the vibration. The Synchra does not transmit vibration through the coupling.”

“If you have a vibrating load shaft the Synchra coupling will not transmit it back to the motor. This will occur if you’ve installed a solid coupling,” Harmon added. “The vibration ends up through the system while our coupling is basically a big shock absorber.”

Another application example involved controlling an aggregate mixer that was causing too much torque and significant damage in the process.

“Our coupling is ideal for overload protection from high torque as it will slip at the same torque specification every time and will not damage the equipment. It will keep the

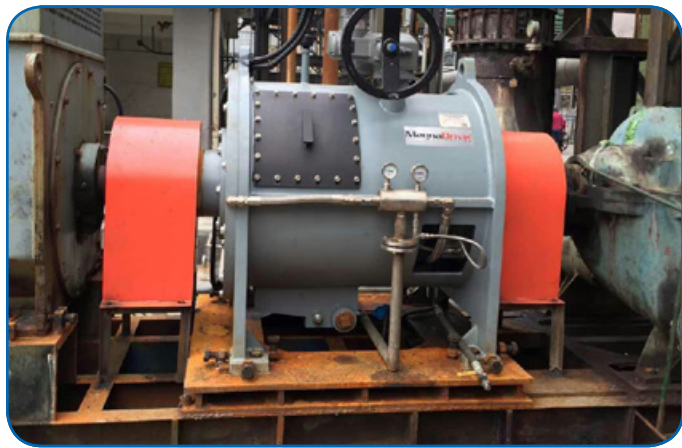

belts from breaking and prevent any damage to motors, bearings, etc.,” Lee said.

Harmon said that the company tests these couplings thoroughly at their own R&D facility before they go out to market. “Even though our customer’s expectations for magnetic couplings are very high and they’ve been on the market for a long period of time, they still want to see advancements in areas like efficiency and reliability.”

With each application, MagnaDrive finds new and exciting ways to bring this magnetic technology to market. Case in point, one of the first customers that purchased the Synchra coupling was for an electric locomotive.

“You never know who might be interested in the technology. It was surprising to find out that our coupling was being used to drive these electric locomotives. This is very different and unique from our other customer requests,” Harmon said.

### Additional Benefits

What are some of the other advantages of this technology? Both Lee and Harmon said there’s no risk from heat due to clashing even from wrong installation or rotating equipment

bearing failure. Only a speed sensor is required to monitor operating conditions for the load speed in case of any RPM slip to prevent some increased vibration. Any RPM slip should trip the coupling so no heat and vibration are generated. Magnet and copper-type couplings always have some slip to operate which can cause heat from magnetic friction. Clashing is also a source for heat from the magnet/copper type couplings, but the Synchra does not slip so clashing does not damage the coupling.

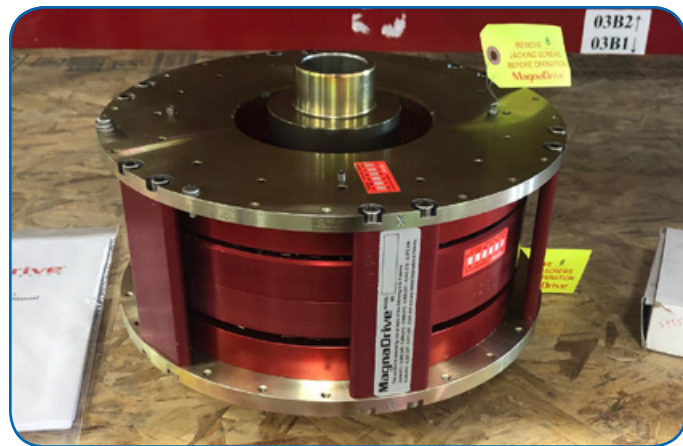

“If customers are using very low-speed applications, the Synchra coupling can be utilized without any heat during operation,” Lee said.

And Harmon believes the diversity of the component is also noteworthy. “You can utilize the Synchra in any pump application where there are misalignment issues, load seizures, shock loading, even boiler feed pumps that run at high temps where the shaft turns the pump and thermal expansion occurs. We will eliminate those issues with the Synchra,” Harmon said.

Material handling is another area where these couplings can thrive. Any application such as conveyors, buckets, elevators or excavators that may need torque protection, for example.

### An Evolving Technology

As machinery evolves, so will the components within each system. MagnaDrive is increasing the horsepower for the Synchra line. They offer 200 and 300 hp capabilities and they’re currently going into 400 hp as well. “We’ll continue to scale up as customer demand increases,” Lee said.

“We’re also working on heatless versions that can be installed in hazardous environments,” Harmon added. “Components that can meet these requirements without any instrumentation or monitoring whatsoever, this would be ideal. We’re looking at that for the future.”

#### For more information:

MagnaDrive Corporation  
Phone: (425) 463-4700  
[www.magnadrive.com](http://www.magnadrive.com)



**MOTION+POWER**  
TECHNOLOGY EXPO

# GEAR ELECTRIC FLUID POWER

 MOVING THE FUTURE.

**OCTOBER 15-17, 2019** | COBO CENTER | DETROIT, MICHIGAN

Shop and compare the full range of power transmission solutions utilizing mechanical power transmission, pneumatics, hydraulics, electric motors, and drives.

**250+** exhibiting companies  
**50** first-time exhibitors showcasing unique solutions

**FLUID POWER PAVILION** — your destination to learn if hydraulics and pneumatics could improve your project.

**EMERGING TECHNOLOGY PAVILION** — provides a look at new, cutting-edge technology that is coming into the manufacturing space.

To search a complete list of exhibitors by name or product category, visit [MotionPowerExpo.com](http://MotionPowerExpo.com)

Owned by:  American Gear Manufacturers Association

Sponsoring organization: 

Co-located with:  HTS  
Holt Training Center  
[www.holttrainingcenter.com](http://www.holttrainingcenter.com)

# ABB

## LAUNCHES SAFETY MOUNT SPHERICAL ROLLER BEARINGS

ABB has launched Dodge Safety Mount spherical roller bearings with a built-in patented locking mechanism that reduces installation time by up to 75 percent compared to traditional products. Best suited for bulk material and air handling applications, the new bearing mounts by tightening fasteners instead of using a hammer and other tools. The new system also allows for simple installation and removal from the same side of the bearing, which means only one person is needed for

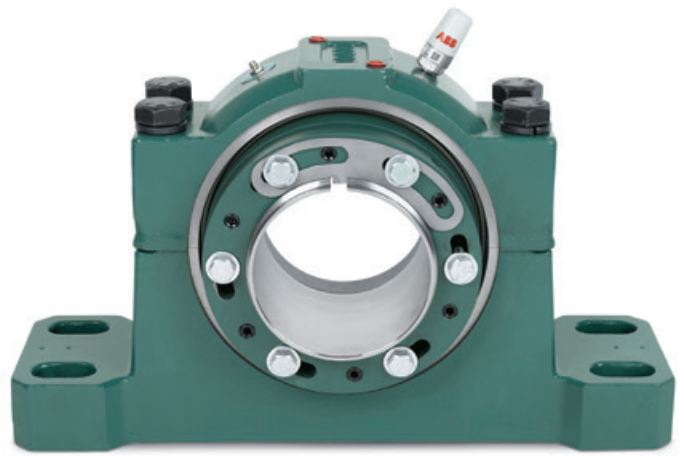

## CLUTCHES & BACKSTOPS

### Prevent Reverse Rotations & Overheating

Quality designs and features are key when it comes to clutches and backstops. From preventing reverse rotations to overheating, Tsubaki clutches and backstops are designed to outperform the competition.



YOUR **TSUBAKI** SIDEKICK FOR  
**OPTIMIZING OPERATIONS.**

©2019 U.S. Tsubaki Power Transmission, LLC All Rights Reserved.

the task.

“The new mounting system replaces the blows of a hammer with the tightening of fasteners,” says Jim Madsen, Dodge mounted roller bearing product manager, ABB. “It also makes it faster to install large bearings, but more importantly, it makes it safer for the installer.”

Safety Mount bearings feature a triple-lip contact seal and corrosion-resistant flinger sealing system which prevents contamination from entering the product during installation and operation. A labyrinth seal option is available for high-speed and high-temperature applications.

Dodge Safety Mount spherical roller bearings come ready for installation of the ABB Ability™ Smart Sensor for mounted bearings, an easy-to-use, wireless sensor that monitors the health of bearings.

Safety Mount spherical roller bearings combine the advantages of the Dodge Imperial family of bearings; factory sealed and greased, shaft ready out of the box, with no feeler gauges required. Safety Mount bearings are offered in split cap and single piece housing options in standard SAE, metric SN, Type E, and Imperial housing dimensions in sizes 4<sup>15</sup>/<sub>16</sub>" to 7" (115 mm to 170 mm).

#### For more information:

ABB  
Phone: (800) 435-7365  
[www.abb.com](http://www.abb.com)



**90** MISSILES

**330** SAILORS

**1,100** MILES OUT  
TO SEA

**ZERO  
ROOM  
FOR GEAR  
DRIVE  
FAILURE.**



Whether it's the frontline combat fleet of the U.S. Navy or your own gear drive operation needs, Philadelphia Gear delivers mission-critical performance and reliable, responsive support.

With unmatched expertise that's on call 24/7, plus complete warranty coverage on workmanship and material for any gear drive we service, including those from other manufacturers, we've set the standard in dependability — on land and at sea — for more than 125 years.

**Keep your mission moving.**

Visit [PhilaGear.com/MyMission](https://PhilaGear.com/MyMission) to learn more.

# Bosch Rexroth

CYTROBOX OFFERS EFFICIENT, INTELLIGENT, COMPACT HYDRAULIC SOLUTION

Connecting machines and facilities with IT systems opens up enormous potential for more economical and intuitive processes. This is exactly where Bosch Rexroth's new CytroBox hydraulic power unit comes in. With its intelligent, energy-efficient modular design, CytroBox provides a new solution for the medium performance range up to 30 kW. With its integrated IoT technol-

ogies, CytroBox is paving the way for consistently implementing Industry 4.0 concepts.

CytroBox is a hydraulic power unit for applications in the medium performance range up to 30 kW. The current consumption is parametrized and optimized with regard to the existing electrical cabinet. Pre-set controllers in variable-speed pump drives adjust



## YOUR BEST SOURCE FOR METRIC

### MOTORS, GEARBOXES & COOLANT PUMPS



Toll Free: 1.800.661.6413 Fax: 1.905.629.2852  
[www.lafertna.com](http://www.lafertna.com) Sales1@lafertna.com

Copyright Lafert North America 2017. All rights reserved.



energy requirements on an individual basis.

The speed is switched off during no load in order to save energy and is controlled under full load in a closed loop to the exact pressure command value with a highly dynamic response. This saves up to 60 percent of energy compared to conventional power units. The high efficiency of the manifold block, which is manufactured using the 3D sand core printing method, also contributes to overall efficient operation. Made via additive manufacturing, the manifold block is up to 40 percent more compact and boasts improved flow channels. This improves oil flow, reduces pressure losses and minimizes the areas where leaks could occur because fewer plug screws are required. The hydraulic power unit is also equipped with an active dewatering unit to protect against external contamination.

**For more information:**

Bosch Rexroth  
 Phone: (800) 739-7684  
[www.boschrexroth.com](http://www.boschrexroth.com)





**MOTION+POWER**  
TECHNOLOGY EXPO

**VISIT US AT BOOTH #3418**

# TRUSTED

## WHEN FAILURE IS NOT AN OPTION

When there is absolutely no room for error,  
we deliver extreme accuracy, reliability,  
and unyielding consistency.



**Excellence  
without  
exception.**



[forestcitygear.com](http://forestcitygear.com)

# Haydon Kerk Pittman

EXPANDS BRUSHLESS DC MOTOR SERIES

Haydon Kerk Pittman is pleased to announce the latest addition to its popular line of brushless DC motors: the EC042B IDEA Motor Series. This revolutionary new product combines exceptional performance with convenience and value.

The programmable IDEA Motor integrates a precision brushless servo motor with an IDEA Drive controller in a compact package to reduce design time, wiring needs, and cabinet space, leading to lower overall system costs. The IDEA Motor is specifically designed for real-time embed-



ded motion control and is ideally suited for autonomous precise execution of complex single-axis motion.

Save money and space by utilizing the IDEA Motor's integrated package of motor, drive, and feedback connections in a compact and programmable unit. A single motor/drive unit reduces motion system components by up to 75% per axis and simplifies machine troubleshooting. Further reductions can be achieved by wiring sensor inputs and control outputs directly to the IDEA Motor, rather than through a control cabinet.

Save time using a pre-engineered, factory-configured and tested servo system. Immediately generate complex precise motion sequences utilizing our free Graphical User Interface that provides an intuitive programming environment to quickly develop, save, and debug complex motion sequences. Since the connections between the drive and motor are made internally, simply connect power, optional I/O connections, and communications, and the IDEA Motor is ready to operate. The EC042B IDEA Motor is also stocked for immediate delivery at the online store.

RS-485 communications fieldbus ports are integrated for programming autonomous motion sequences, monitoring system status, or streaming commands to synchronize motion among multiple motors. The EC042B IDEA Motor is available in three motor lengths, each with optional factory-configurable gearboxes.

### For more information:

Haydon Kerk Pittman  
Phone: (267) 933-2105  
[www.haydonkerkpittman.com](http://www.haydonkerkpittman.com)



## The Power of One<sup>2</sup>

### Your Objective:

One face in perfect alignment with another. *For infinity.*

### No problems. No distress. No delays.

That's the same objective you have for choosing your gear producer. Circle Gear's objective is to engage with every customer's objectives.

- ▶ One to 1000 gears
- ▶ Customer designed or reverse engineered
- ▶ Gearbox repair, rebuild or redesign
- ▶ OEM or end-users
- ▶ ISO 9001:2015 Certified

1501 S. 55th Court, Cicero, IL 60804  
(800) 637-9335  
(708) 652-1000 / Fax: (708) 652-1100  
[sales@circlegear.com](mailto:sales@circlegear.com)  
[www.circlegear.com](http://www.circlegear.com)



Spiral and Straight Bevel Gears (*Cut, Ground or Lapped*) • Spur Gears • Helical Gears • Long Shafts • Herringbone Gears • Involute and Straight Sided Splines • Internal Gears • Worm and Worm Gears • Racks • Sprockets • ISO Certified



Partnering with QualityReducer to provide  
Gearbox repair, rebuilding and reverse-engineering.



# THE **SUPERIOR** CHOICE

WEG's proven reliability in a Rolled Steel frame



- Rated Output: .25 to 25 HP
- 3600, 1800, 1200, 900 rpm
- 48-256T frame
- Foot mount, C-Face or footless available
- AEGIS® SGR Inside (up to 20 HP in stock)
- Brake Motors now available

- Robust base and eyebolts
- Superior Cooling System
- Dual Rated 50/60 HZ
- Class F Insulation
- Aluminum Enshields



**Wide Range of Configurations in stock.**

Transforming energy into solutions.

[www.weg.net](http://www.weg.net) | 1-800-ASK-4WEG

# Igus

DEVELOPS INTELLIGENT PLAIN BEARING

Igus has developed an intelligent plain bearing, a high-performance plastic that warns of failure and allows machine and equipment operators to plan maintenance, repairs or part replacement in advance. Plain bearings have to withstand considerable adverse influences, such as abrasive dust, chemicals and high speeds. The intelligent bearing from Igus allows operators to

schedule replacement and thus reduce unexpected, costly and lengthy downtime.

If a building machine fails, packaging equipment comes to a standstill, or a wind turbine no longer revolves due to a bearing failure, the breakdown creates stress for operators of the machines and equipment. The



intelligent bearing detects wear and sends a signal to the user if the bearing threatens to fail. Maintenance work can therefore be planned, and operators of agricultural machines, for example, are not surprised during harvest season with an unanticipated breakdown and work stoppage.

“We have primarily developed iglide for difficult-to-access bearing points and for applications where no regular maintenance intervals have been planned,” said Stefan Loockmann-Rittich, head of the business unit iglide plain bearings at Igus GmbH.

## Smart Plain Bearings Are Individually Designed

The body of the new smart iglide plain bearing consists of two components: the internal, lubrication-free iglide material and an outer hard polymer shell that protects the bearing. “The customer can choose the material that is most suitable for the application. “The complete range of iglide materials is available,” Loockmann-Rittich said.

In order to measure the amount of wear, an intelligent sensor is used between the two components. The measured data of the sensor can be integrated by the machine and equipment operators in their systems in different ways.

### For more information:

Igus Inc.  
Phone: (800) 521-2727  
[www.igus.com](http://www.igus.com)

## UNWIND & REWIND TENSION CONTROL SYSTEMS



MAGNETIC PARTICLE BRAKES  
MAGNETIC PARTICLE CLUTCHES  
DIGITAL CONTROLLER

## LINEAR & ROTARY AXIS DRIVES



HIGH-TECH PLANETARY REDUCERS  
RACKS & PINIONS  
SLEWING RING BEARINGS

## RIGHT ANGLE CONVEYOR GEARBOXES & LUBRICATORS

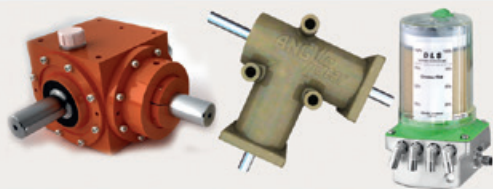

RIGHT ANGLE BEVEL  
SPIRAL BEVEL GEARBOXES  
AUTOMATIC  
LUBRICATION SYSTEMS



Visit us! Booth #C5608

September 23–25, 2019  
Las Vegas Convention Center  
Las Vegas, Nevada USA

# ANDANTEX USA Inc.

[andantex.com](http://andantex.com)

[info@andantex.com](mailto:info@andantex.com)

Phone: 877-966-9151

1705 Valley Road, Wanamassa NJ 07712



STOCK DRIVE PRODUCTS/STERLING INSTRUMENT  
a Designatronics company

ENGINEERING  
MANUFACTURING  
ASSEMBLY



## GET COMPONENT OPTIONS AND DESIGN SOLUTIONS

Gears, Timing Belts & Pulleys, Bearings, Couplings, Hardware  
Custom Mechanical Solutions | Precision Machining | 3D Printing

REGISTERED  
**ISO 9001**  
**AS 9100**

Stock Drive Products / Sterling Instrument  
250 Duffy Avenue, Hicksville, NY 11801  
Phone: (800) 819-8900 Fax: (516) 326-8827  
email: [sdp-sisupport@sdp-si.com](mailto:sdp-sisupport@sdp-si.com)  
[www.sdp-si.com](http://www.sdp-si.com)

REQUEST A CATALOG



# Applied Motion Products

NEMA 24 FRAME INTEGRATED MOTORS OFFER DUAL-PORT COMMUNICATIONS

Applied Motion Products introduces two new NEMA 24 frame integrated motors with dual-port communications for connecting to the industrial EtherNet/IP network of a plant or machine. By incorporating two M12 EtherNet/IP connectors instead of just one on each axis, the SWM24IP-3DE Integrated Stepper Motor and TXM24IP-IDG StepSERVO Integrated Motor support more efficient network topologies such as line networks and daisy-chain connections.

EtherNet/IP network communications are the widely used industrial protocol for manufacturing automation applications. With EtherNet/IP, users can control, configure and query a drive using an open, standards-based, industrial EtherNet connection at speeds up to 100 Mbits/sec. All drive and motor features are accessible over the EtherNet/IP network, including

more than 100 commands and 130 registers for controlling motion, I/O, configuration, polling, math, register manipulation, and Q programming.

The additional EtherNet/IP communications port on the motors allows for cost savings and design simplification by reducing cables, eliminating bulky

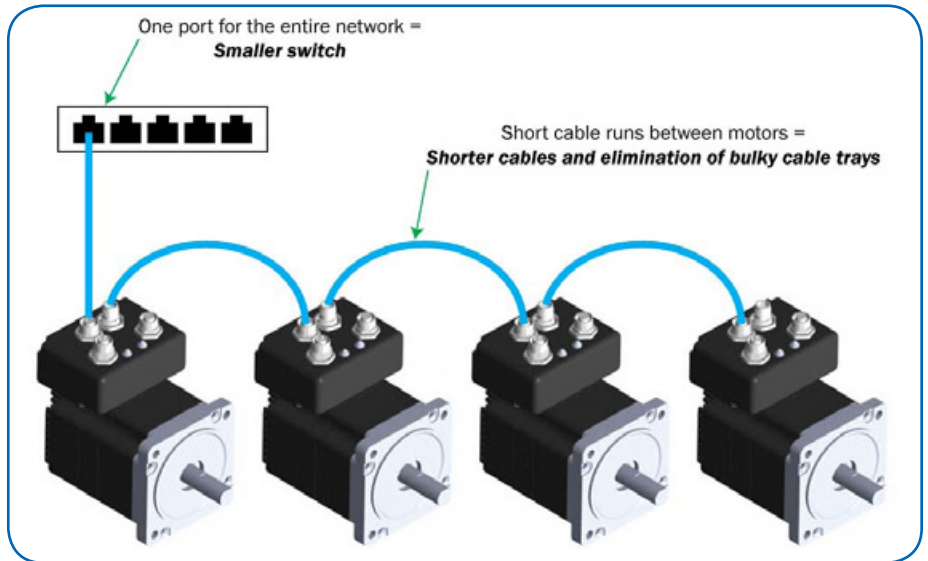

## The search is over!

For quality spiral bevel gearboxes that provide improved performance, high reliability and easy maintenance, look no further than DieQua.



- 9 sizes
- 15 ratios
- Power capacities from 1-300 HP
- Low Backlash
- Customizable
- Mounting on all 6 sides

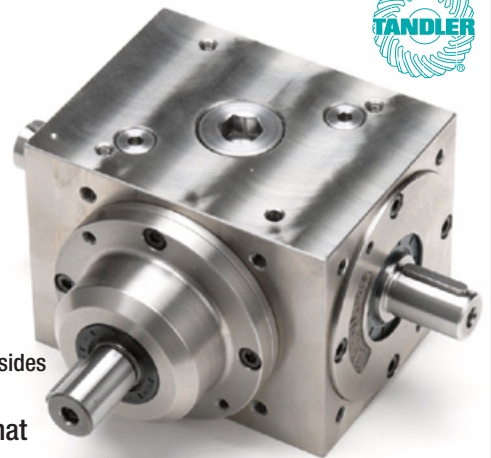

To finally find what you're looking for, check us out on the web, or give us a call.

[diequa.com/pte](http://diequa.com/pte) 800-430-1439

**DIEQUA**  
Corporation

cable trays and downsizing network switches. For example, in a star network, every single motor must connect to the central switch on a dedicated cable. In a line network using motors with dual-port communications, only the closest motor connects to the switch with the rest connecting to each other in a daisy-chain configuration. In addition to shortening cable runs between motors, only one port is needed for the entire network, which means a smaller Ethernet switch.

The SWM24IP-3DE and TXM24IP-1DG integrated motors are IP65 rated for use in splash-zone and dirty environments. Each motor features a NEMA 24 (60 mm) mounting flange, which has the same mounting dimensions as a NEMA 23 motor but with a larger shaft to accommodate a higher torque output. Both

motors include a built-in encoder for enhanced positioning capabilities. The SWM24IP-3DE can perform stall detection and stall prevention functions for more reliable and accurate performance than an open loop motor in a broader range of applications.

The TXM24IP-1DG utilizes Applied Motion's StepSERVO Closed-Loop Stepper technology to greatly improve the performance of the step motor with greater acceleration, increased efficiency, increased accuracy as well as decreased motor heating and noise.

**For more information:**

Applied Motion Products  
Phone: (800) 525-1609  
[www.applied-motion.com](http://www.applied-motion.com)

To be considered for inclusion in our Product News section, send your press releases to Senior Editor Matthew Jaster, [mjaster@powertransmission.com](mailto:mjaster@powertransmission.com). Please be sure to include one or more high-resolution photos with your submission. We regret that we don't always have room for all the submissions we receive, but you can find even more of the latest power transmission and motion control products online at [www.powertransmission.com](http://www.powertransmission.com)

**MASTA**

Next generation CAE software for the design, analysis and optimisation of transmission systems

DESIGN      ANALYSE      OPTIMISE

Discover more at [masta.smartmt.com](http://masta.smartmt.com)

DESIGN GEARBOX AND DRIVELINE SYSTEMS FROM CLEAN SHEET OR IMPORTED CONCEPTS

RUN AND GENERATE REPORTS ON A WIDE VARIETY OF ANALYSES INCLUDING STATIC DEFLECTIONS, DURABILITY, EFFICIENCY, FREQUENCY DOMAIN NVH, TIME DOMAIN DYNAMICS AND MORE

**SMT**

Globally integrated leader in mechanical transmission engineering services and software development

© 2019 Smart Manufacturing Technology

# KISSsoft Makes it Possible to Analyze Contact Patterns for UAV Helicopter Transmissions in Prototype Trials

Amri, Hartenthaler, Koo, and Langhart

In a research project at the Vienna University of Technology, the *KISSsoft* design software was used to check a new drivetrain concept and the micro-geometry of the bevel gear stage for a UAV (unmanned aerial vehicle). The gear set was then tested in a prototype transmission on a test bench and contact pattern verifications were conducted to validate the design. The tests showed that the contact patterns from the simulation were not achieved during the first trial. After analyzing gearbox displacements in the simulation and correcting the mounting distances of the bevel gear set on the test bench, the contact patterns proved to be consistent between the test and the *KISSsoft* results.



Figure 1 CamCopter S-100 in use.

## Introduction and Motivation

The focus of research by the Machine Elements Research Department of the Vienna University of Technology, directed by Professor Dr. Weigand, is on aviation propulsion systems. They include drivetrains for rotary wing

aircraft of all sizes as well as transmissions for fixed-wing aircraft and turbines. The activities of this department range from concept designs to detailed analyses of transmissions, certification issues and test bench trials. The segment of new drive designs for UAV's is experiencing rapid growth in aviation. These UAV's include autonomous helicopters with a take-off weight of around several hundred kilograms.

The CAMCOPTER S-100 from the Austrian company Schiebel Elektronische Geräte GmbH is an unmanned helicopter with a maximum take-off weight (MTOW) of 200 kg and a payload of 50 kg which is operated by a Wankel engine. Its maximum speed is 240 km/h, its maximum flight altitude is 5,500 m by an operating time of minimum 6 hours (Figure 1).

As part of the OHE (Optimized Helicopter Drives Made in Austria) cooperative research project between the Vienna University of Technology and the company Schiebel, the new transmission design was reviewed on

Figure 2 Bevel gear set from the output stage of the new transmission.

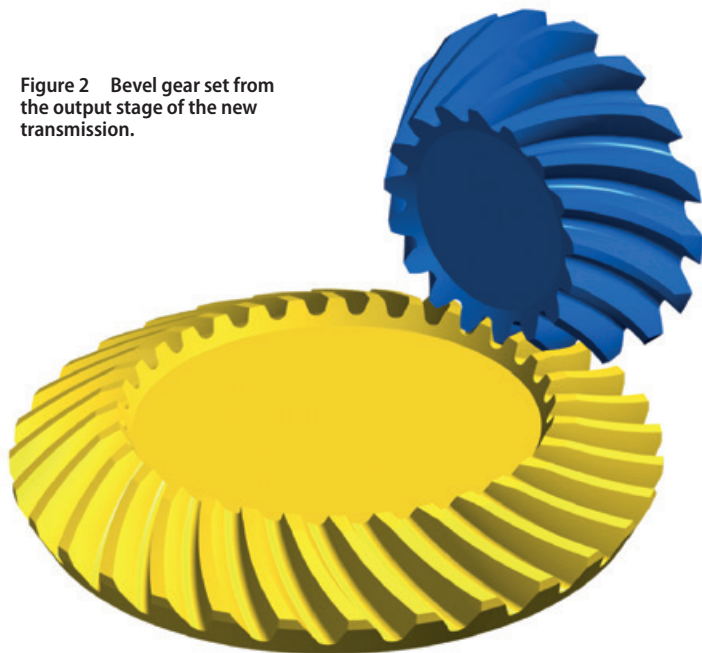



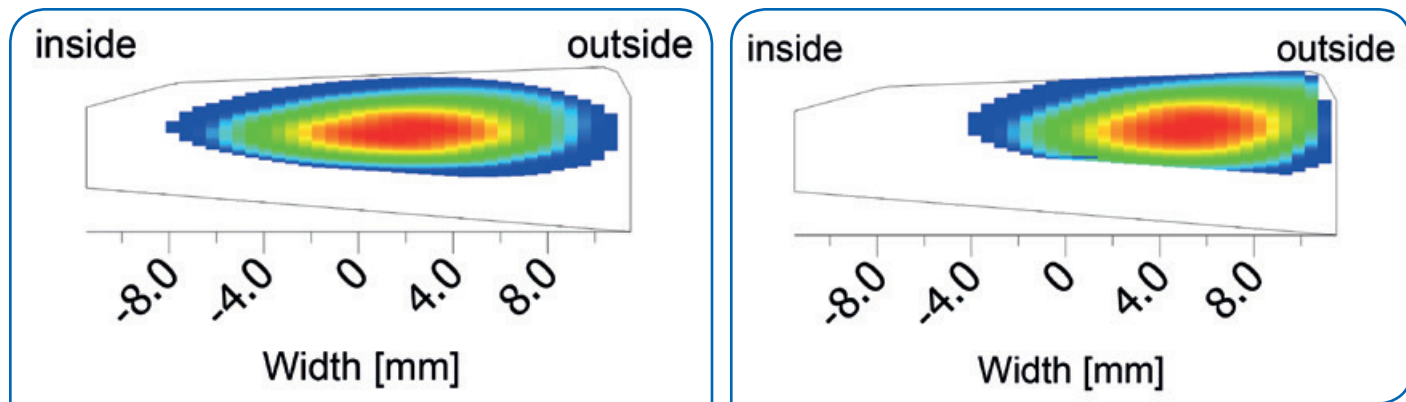

Figure 3 Variation of the mounting distance from the ring gear and its effect on the contact pattern (left without backlash, right with displacement of the ring gear).

a test bench specially made for the CAMCOPTER S-100 at the Institute of Engineering Design at the Vienna University of Technology. The bevel gear stage tested is the output stage to the main rotor and has a transmission ratio of around 1.9 and a shaft angle not equal to  $90^\circ$ . The bevel gear set was manufactured in a conventional face milling process. The micro-geometry was specially designed for this gear set, since the deformations are greater in aviation transmissions than in industrial gearboxes, because of the radical light-weight design, particularly of the housing. The gear set—together with the new contact pattern specifications from the Vienna University of Technology—was given to the bevel gear set manufacturer commissioned to manufacture the transmission and determine the flank modifications (Figure 2).

It was shown on the test bench that the manufactured bevel gear set did initially not have a satisfactory contact pattern. The contact pattern was shifted significantly toward the heel and tip on the ring gear. This led to the issue and challenge of identifying the cause of the error and of determining and eliminating the relevant parameters. The drivetrain and the bevel gear stage were designed with *KISSsys*—the *KISSsoft* system add-on—software from *KISSsoft* AG, and the contact pattern was calculated under various loads, including the corresponding profile and lengthwise crowning as well as the spiral angle/pressure angle modifications.

### Contact Analysis of the Bevel Gear Stage Using *KISSsoft*

*KISSsoft* was used to conduct a contact analysis under full load and evaluate the contact pattern on the ring gear. To calculate the contact pattern, the contact analysis software uses a bevel gear model based on the cylindrical-gear profile as well as flank modifications based on the definition of mathematical approaches. In contrast, conventional manufacturing of bevel gears is based on the theoretical generating

of the plane gear and flank modifications based on machine settings. Because the bevel gears normally have rather large crowning, the difference between the approach of *KISSsoft* and the conventional manufacturing in the contact pattern is low, and this enables a simulation in *KISSsoft* based on the analytical approach of Weber/Banaschek to obtain a good estimation of the contact pattern under load. The contact analysis also provides an evaluation of the gear set according

# We're Proven.

**Our gears are trusted in the most advanced machines on the planet.**

When failure is not an option, Spiroid Gears step in. Our gear solutions are depended on and used in nuclear power plants, commercial jets and national defense systems. We produce greater torque in less space with reduction flexibility and positive backlash control. Spiroid's skew-axis, high torque gears enable world-class power density.

Visit us on-line for details.

**SPIROID**  
HIGH TORQUE GEARING



**SpiroidGearing.com**

ROBOTICS • AEROSPACE • DEFENSE • TRANSPORTATION • MEDICAL

**MOLON**  
MOTOR & COIL CORPORATION

CERTIFIED  
ISO 9001-2015  
ISO 13485



**Motor Solutions  
Thru  
American Innovation**

We don't leave the manufacturing and engineering of our products to other countries.

**AMERICAN  
MANUFACTURER  
EST. 1954**

VISIT OUR WEBSITE:  
**www.Molon.com**

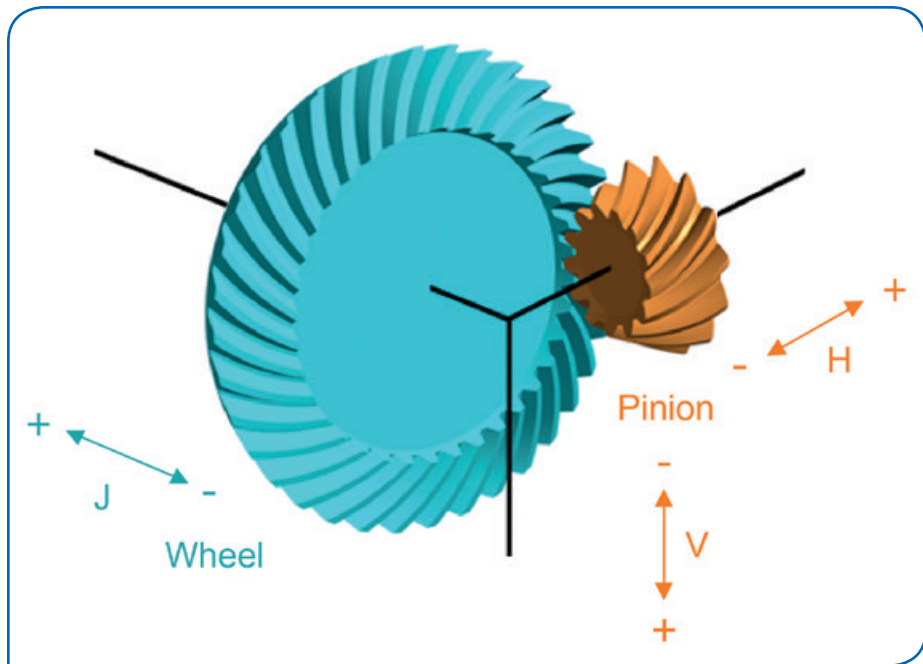

Figure 4 Definition of the displacements on the bevel gear.

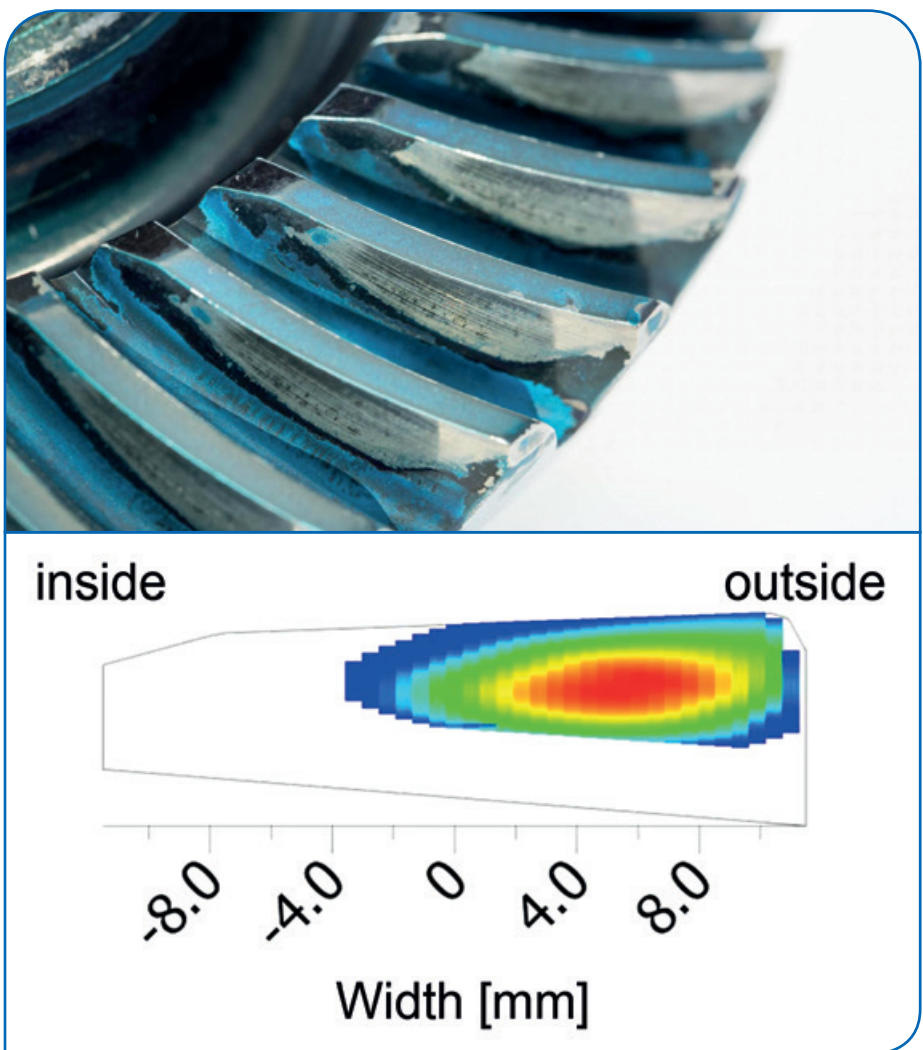

Figure 5 Identical contact pattern from test bench (top) to simulation (bottom) after correcting the mounting distance.

to various criteria such as tooth root stress, tooth flank fracture, or scuffing. On the other hand, experience shows that more sensitive criteria—such as noise evaluation due to transmission error—also require the real topology from the production simulation.

### Contact Pattern Displacements in *KISSsoft*

To determine the cause of the poor contact pattern on the test bench, the theoretical gearing data was first compared to the manufacturing data, and the gear set was checked for any potential manufacturing errors. No differences were found here. The load assumptions from the simulation were also correct and agreed with measured values from the test bench. The circumferential backlash, which was adjusted when mounting the ring gear, was then tested as another possible source of the poor contact pattern. For comparison, the parameters for the assembly deviations were subsequently varied in *KISSsoft* to simulate the contact pattern from the test (Figure 3).

### Contact Pattern Testing on the Test Bench

In *KISSsoft*, a parametric study was conducted with various mounting distances for the ring gear in the J+ direction (Figure 4). Now, this showed that the faulty contact pattern from the test bench was obtained also in the simulation.

In turn, this finding suggested that, on the test bench, the crown wheel was mounted incorrectly with respect to the mounting distance, thus making the backlash incorrect. Finally, an inspection of the assembly process showed that the backlash was not set correctly, which had led to the unexpected result. After correcting the mounting distance of the ring gear, a contact pattern identical to that of the simulation in *KISSsoft* was obtained on the test bench (Figure 5).

The unfavorable contact pattern leads to nonuniform load distribution over the flank under high loads, and thus to excessively high stresses, which, in turn, have adverse effects on load-bearing capacity. A uniform load distribution was achieved using the correct contact pattern.

### Summary and Outlook

In the past, the manufacturer would come up with a new design of a bevel gear pair and define the flank modifications based on their own experience. In aviation, this approach does not always lead to the desired results, because these transmissions are subject to other deformations as well due to the radical lightweight design and different mounting systems. Especially in aviation, it is therefore essential to make use of drivetrain software to predict the contact pattern and verify it in a test run.

In the application example presented, *KISSsoft* was used successfully to lay out the contact pattern and to troubleshoot faults after the production process. State-of-the-art drivetrain software is able to recognize contact pattern displacements in comprehensive analyses and propose suitable flank modifications. This leads to realistic results and contributes significantly to achieving high-end developments at reasonable costs. **PTE**

#### For more information:

*KISSsoft* AG  
A Gleason Company  
[www.KISSsoft.com](http://www.KISSsoft.com)

For Related Articles Search

software

at [www.powertransmission.com](http://www.powertransmission.com)

VISIT US AT  
M+PT EXPO 2019  
Booth #2922

# FORGING AHEAD OF THE PACK

MADE IN THE  
USA

**Fast.  
No Fine Print.  
No Premium.**

At McInnes Rolled Rings, we provide quality products, shipped fast. And we partner that with exceptional customer service to forge the perfect partnership with our customers.

**McINNES  
ROLLED RINGS**

**1.877.736.4409**

[www.McInnesRolledRings.com](http://www.McInnesRolledRings.com)

# Using Couplings to Reduce Downtime

Joseph L. Hazelton, Contributing Editor

**Downtime, downtime, downtime.** When it's planned, it's bearable. When it's not, it's not.

To maintain machinery, planned downtime is necessary. To fix broken equipment, unplanned downtime is excruciating, especially when your factory is running closer and closer to full capacity.

Now, the effort to reduce downtime, planned and unplanned, is ongoing in industry. However, in that effort, some companies are paying more and more attention today to the couplings on their drivelines. This tendency has been noticed by some manufacturers of couplings.

And what's being done with couplings to reduce downtime?

In heavy industry—that is, in heavy-duty, high-speed applications—two trends are 1) to remove a type of coupling and replace it with another type and 2) to reduce a coupling's weight in order to reduce possible imbalance.

Of course, changes should be made when conditions are right, such as after considering various factors and deciding a change is suitable and beneficial.

In the first trend, the change, installing a new type of coupling, depends on the type being replaced.

When a shear pin is being removed, what's often being installed is a torque limiting coupling. That's the tendency pointed out by Andy Lechner, chief marketing officer for R+W America, a coupling manufacturer in Carol Stream, IL. R+W America makes a number of different couplings and serves the mining and tunneling industry and the steel industry, among others.

When the type of coupling removed is a gear coupling, the type often replacing it is a disc coupling. That's what has been noticed by Manuel de Lama Santos. He's product manager-couplings for Flender Corp., a couplings maker in Elgin, IL. Flender manufactures various couplings and serves heavy industries like cement and mining as well as oil and gas.

## From a Pin to a Coupling

In heavy industry, Lechner says the trend is affecting rolling-mill operations, like steel mills. As he explains, some mills are operating closer to full capacity than they used to. In many cases, though, their drivelines are equipped with shear pins.

Now, shear pins do their jobs fine. They hold a driveline together and prevent catastrophic damage to the line when there's a torque overload. "Those have been a low-cost way of protecting from torque overloads on mill stand drives for many decades," Lechner says.

Once broken, though, a shear pin can become a pain. It can take up some downtime, even more when the line uses a set of shear pins. The downtime is spent removing the pin's broken pieces and installing a new pin. According to Lechner, this process may take hours, like up to four. If the

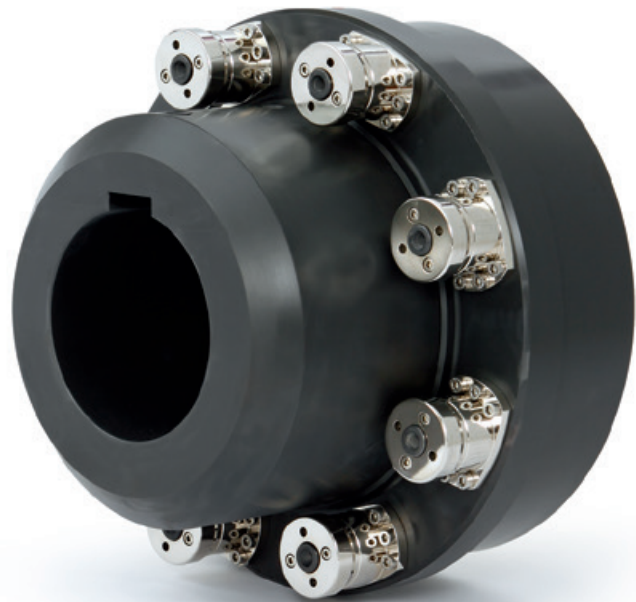

A number of torque limiting couplings can be used in high-speed applications, with many models having maximum speeds of more than 3,600 rpm—much more. (Photo courtesy of R+W America)

factory's running at near full capacity, hours of downtime may be unacceptable. "The busier an operation is, the more valuable that time is," Lechner says.

To reduce downtime, the pin could be replaced with a torque limiting coupling. An advantage of the coupling is it can be reset. For example, a coupling's design may allow it to be reset mechanically. With the ability to be reset, when an overload occurs and a coupling disengages a driveline, the coupling could be reset by prying back its plungers. Then, the line can be re-engaged and the machine restarted. Lechner

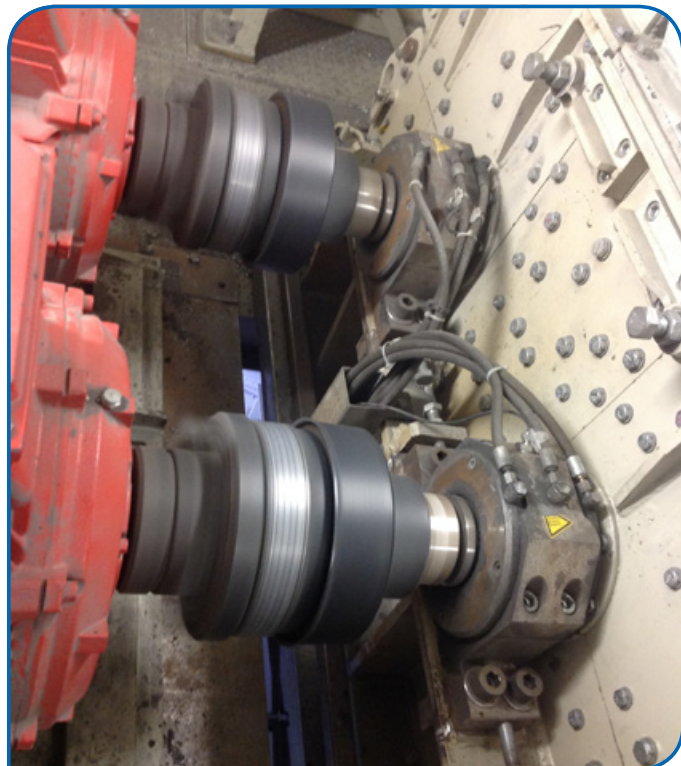

After a torque overload, a driveline's downtime may be shortened if the line uses a torque limiting coupling instead of a shear pin or a set of shear pins. (Photo courtesy of R+W America)

describes the difference between a coupling and a pin in this way: “It’s like a circuit breaker rather than a fuse.”

A torque limiting coupling costs more than a shear pin, though, so you should run all the cost numbers for both devices. Examples of the numbers are product cost and downtime cost. Also, a coupling takes up more space than a pin. A pin is compact and can vary in size, number, and material while providing a driveline with protection from torque overload.

Because a torque limiting coupling is bigger, a company will need to figure out whether its driveline has enough space for the coupling. If it doesn’t have enough space, the benefit of switching to a coupling would need to be weighed against the time and effort to move the line’s engine/motor and gearbox to create the space. If the benefit is sufficient, then the company would need to do some work before installation of the coupling.

“But, for the right applications, it’s typically a single disengagement that yields ROI for maintenance managers,” Lechner says.



With a disc coupling, a driveline can require less downtime because a disc coupling doesn’t have lubricating oil/grease and seals that need to be maintained, a gear coupling does. (Photo courtesy of Rexnord Corp.)

### Switching to a Disc Coupling

If a driveline uses a gear coupling, then the switch to reduce downtime is often a switch to a disc coupling these days.

According to Flender’s de Lama Santos, this switch is happening in several types of heavy-industry companies, like steel mills, mining operations, and cement makers.

And, to clarify, de Lama Santos explains that when he says cement makers, he’s talking about companies that operate rock crushers to make fine stone for cement; he’s not talking about companies that mix and pour concrete at curbside.

Also, he describes how a switch to disc couplings can reduce downtime. Specifically, a gear coupling uses lubricating oil/grease for its gear teeth and has seals. Both lubricant and seals need to be changed from time to time to maintain the coupling in good order. Otherwise, the coupling will

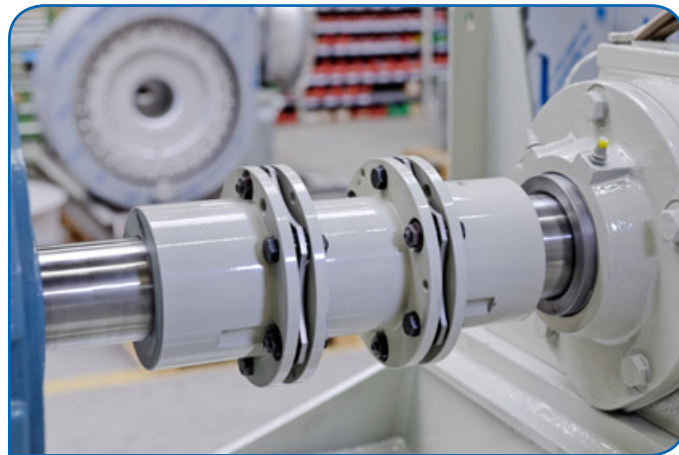

In the right application, a gear coupling can be replaced with a disc coupling so a factory can reduce a driveline’s maintenance time. The reduction would be most important if the factory were operating at or close to capacity. (Photo courtesy of Flender Corp.)

degrade, and the factory will face unplanned downtime.

A disc coupling doesn’t use gears. Instead, it transmits mechanical power through several thin, flexible discs. The discs are steel, though. So, a disc coupling is still power dense, Santos says. And since there are no gears, a disc coupling doesn’t use lubricant or have seals. The driveline’s planned maintenance time can be shortened.

Moreover, according to de Lama Santos, a disc coupling is meant to be maintenance-free. He adds that disc packs are meant to be durable: “They will last for a lifetime, if used properly.”

### Complications of a Switch

However, a switch from one type of coupling to another type can get real complicated real fast.

One complicating factor can be whether the driveline is powered by an engine or a motor. This factor is explained by John Malik.

Malik is general manager for TB Wood’s and Ameridrives couplings in San Marcos, TX. TB Wood’s and Ameridrives are two brands of couplings made by Altra Industrial Motion Corp., Braintree, MA. Altra makes couplings for a number of heavy industries, including metal processing, mining, and oil and gas.

According to Malik, a switch involving a line with an engine can require more upfront, engineering work to understand whether the line would need to be changed or how it would need to be changed in order to make the switch.

As an example, he mentions a switch from a type of coupling that’s high maintenance to a type that’s low maintenance. “The weight, the inertia, the stiffness,” he says, “all might be different and that’s going to affect the machinery dynamics, so you’ve got to be careful.”

### Tradeoffs: Finding the Right Mix

Of course, a switch between types of couplings will likely involve tradeoffs, losing an advantage here, gaining one there, losing a disadvantage here, “gaining” one there. What advantages you want and disadvantages you can accept, depend on what you figure is the best way to reduce downtime.

Now, a coupling that offers all the advantages you want,

it may exist today, but it's not likely. So, when you look into switching to another type of coupling, have your wish list at hand, but be ready to start prioritizing its items.

Also, be ready to be told some parameters don't go together. For example, Malik mentions that factories may request a coupling that's low maintenance or maintenance-free and that allows for higher misalignment. As he points out, those parameters are at odds with each other. The allowance for misalignment may be requested so the factory can keep down the time and cost of installation. But, if you have more misalignment: "You get more reaction force," Malik says.

He then adds an example to show the possible consequences of conflicting parameters. His example isn't heavy industry, but it does illustrate his point. The example is a turbine-powered generator mounted on a big truck for use as a mobile, auxiliary power unit.

Rather than use a high-performance coupling, the customer asked that the system use a universal joint to permit three degrees of misalignment. The u-joint may create a problem for the turbine, though.

Malik explains that generally, turbines are very precisely designed and have bearings designed to support a very light

weight, very well-balanced coupling. The u-joint with three degrees of misalignment wouldn't be as well balanced as it should be. And a u-joint is generally much heavier than a high-performance coupling.

Given more weight and less balance: "You run the risk of tearing the bearings out of the equipment," Malik says. Depending on the machine system, a possible result could be a short life ending in catastrophic failure.

### A Complicated Switch due to a Sophisticated System

A switch can become more complicated when the whole machine system is more sophisticated or when the new type of coupling is being retrofitted onto an existing system.

Malik offers a higher-end example: a turbine-powered system running a turbo-compressor at 5,000-plus rpm. Before switching the system's coupling, you'd need to figure the new coupling's effect on the system. "Now, you've got to rerun the machinery dynamic studies, whether it's torsional vibration analysis, lateral vibration," Malik says.

In such cases, a system's owner may need to hire a consultant who can take into account all of the system components in order to ensure that after the switch, the system still works as expected and now includes the benefits of the new type of coupling.

According to Malik, such consultants are limited in number because of the expense and expertise needed to buy and run the software that models complex machinery systems. Once hired, the consultant would look at the system components and contact the various component manufacturers as needed, working with them while tweaking the system's computer model in order to permit a switch in coupling. "It's a big team effort," Malik says.

The other trend, reducing a coupling's weight to increase its balance, that trend has been noticed by Lechner and by Bill Holtz. Holtz is a senior engineering manager for couplings with Rexnord Corp. Located in Milwaukee, WI, Rexnord manufactures various couplings and serves a number of industries, including heavy industries like energy and mining.

Now, this trend has the same goal as the first: reducing downtime.

### Higher Speeds, More Imbalance

Machinery keeps getting bigger and bigger and keeps running faster and faster. Now, for a couplings maker, customers wanting bigger machines isn't a problem, but their wanting faster ones is.

"As they start pushing more power at higher speeds, what ends up happening is more opportunities for imbalance," Holtz says.

According to Lechner, heavy industry—industry in general—is running at higher speeds because doing so is more efficient. Holtz provides an example, two centrifugal pumps. One pump operates at 1,800 rpm, the other at 3,600 rpm. If both pumps are moving fluid at the same rate, the pump operating at 3,600 rpm would be about half the size of the pump operating at 1,800 rpm.

But increased speed means increased forces on the

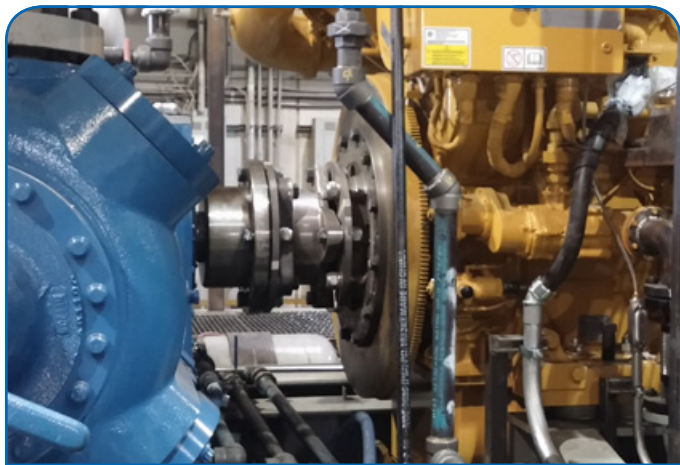

Depending on the application, a coupling's weight may be a fraction of a driveline's overall weight or may be the bulk of that weight. This coupling connects an engine and a compressor. (Photo courtesy of Altra Industrial Motion Corp.)



Generally, switching from one type of coupling to another type becomes more complicated as the whole machine system becomes more complicated. (Photo courtesy of Altra Industrial Motion Corp.)



In heavy-duty, high-speed applications, a coupling's weight should be kept to a minimum because more weight can mean more unbalance forces, which are amplified at higher speeds, creating unwanted stress, wear, and downtime. (Photo courtesy of Rexnord Corp.)

components of a machine system. For the coupling, greater speed means an increase in unbalance forces, an exponential increase. "When I double the speed," Holtz says, "my unbalance force doesn't double; it's squared."

Now, even just some imbalance in a driveline can start a train of bad effects. "It causes vibration, which then causes materials to shift, materials to fatigue," Holtz says. "And then, you're into downtime."

As industry wants to run ever faster, coupling manufacturers have a few ways to reduce imbalance in their couplings. Holtz explains that unbalance forces are affected by speed, weight, and eccentricity.

### Reducing Weight to Reduce Imbalance

Now, to reduce weight in order to reduce imbalance, that effort starts with improving the materials used to make couplings. "We're always working to make stronger materials so

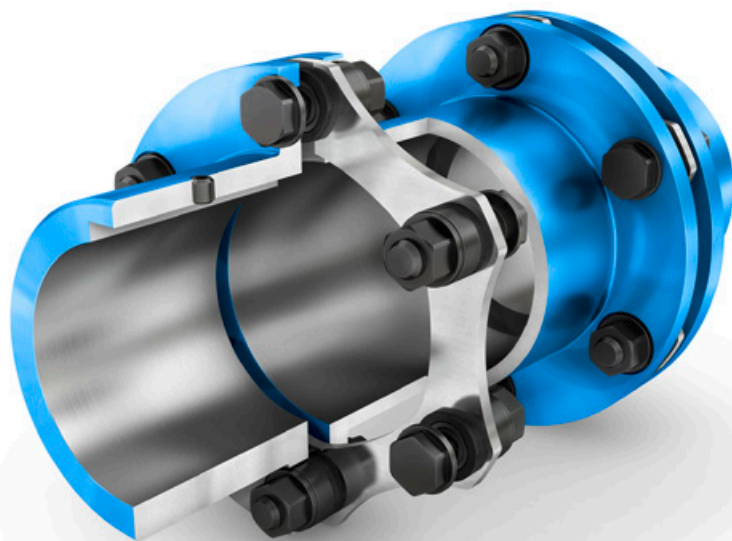

A stronger material can lead to a coupling with reduced imbalance. With a stronger material, a coupling's bore capacity becomes greater. The coupling can be made thinner, using less material, resulting in less weight, which reduces possible imbalance. (Photo courtesy of Flender Corp.)

that we can have thinner cross sections so we can have less weight and then, therefore, better balance," Holtz says.

Also, the effort is supported by the latest software for finite element analysis and modeling and by more sophisticated dynamometers and test stands. Speaking generally about couplings, Lechner says, "The sophistication and the ability to improve on these designs has increased with the help of FEA and advanced modeling." He adds that today's dynamometers and test stands have more sensors and more responsive electronics, so they can provide performance data that's larger in amount and more real-time.

Consequently, a coupling manufacturer can remove more material, can test the coupling, and still be confident the lighter weight doesn't affect the coupling's performance. That way, a coupling can be right-sized, not oversized.

### Other Benefits

Also, in the right driveline, a lighter weight coupling can contribute to a machine performing better and costing less. It can help improve performance because its lighter weight can reduce a machine's moment of inertia. Less inertia means less power needed to bring the machine up to speed. The coupling can help lower cost by reducing power consumption, possibly to the point where the machine can use a smaller power source, whether engine or motor.

These contributions may be greatest when a coupling makes up a large part of a driveline's total weight. So, the smaller the coupling's weight in proportion to the line's total, the smaller the coupling's contribution may be to better performance and less cost. Even when a small portion, though, a coupling's lighter weight may still be enough to tip the scale for the whole driveline.

However, you have to be careful. Although more precisely engineered and better balanced, a lighter weight coupling can have a smaller safety factor, a smaller margin of error, so it may not be able to withstand some shocks.

Also, if too much weight, too much material, has been removed, a coupling could actually contribute to the thing you don't want. It could lead to downtime, including that worst kind: unplanned. **PTE**

### For More Information:

Altra Industrial Motion Corp.  
Phone: (781) 917-0600  
[www.altracouplings.com](http://www.altracouplings.com)

Flender Corp.  
Phone: (847) 931-1990  
[www.flender.com](http://www.flender.com)

R+W America  
Phone: (630) 521-9911  
[www.rw-america.com](http://www.rw-america.com)

Rexnord Corp.  
Phone: (414) 643-3000  
[www.rexnord.com](http://www.rexnord.com)



# Power Transmission Engineering

## Free Knowledge Served Daily

For even more great information on couplings, including technical articles, features and insight from the leading manufacturers, case studies and application examples, visit the *Power Transmission Engineering* archive.

[www.powertransmission.com/couplings](http://www.powertransmission.com/couplings)

But don't stop there! Just type what you're looking for into our search box at the top-right of any page, and you'll find just as much great information from our archives on virtually any topic related to mechanical power transmission and motion control, whether it's gears, bearings, motors, clutches, chain, gearboxes and more.

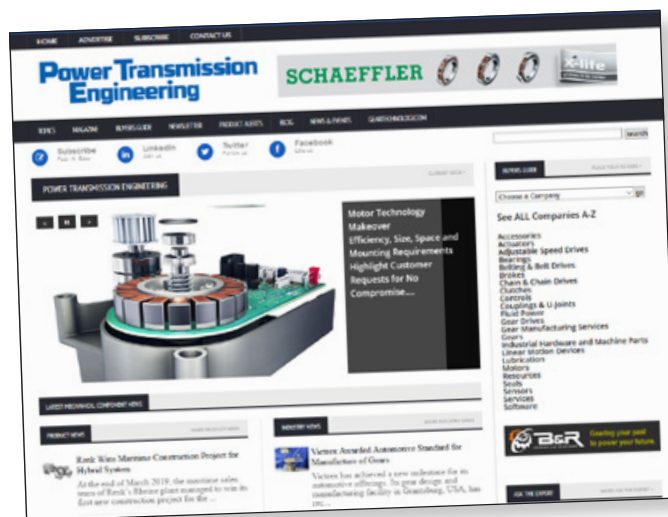

## Power Transmission Engineering

**FOR MORE INFORMATION**  
 1840 Jarvis Avenue, Elk Grove Village, IL 60007  
 Phone: 847-437-6604  
 Fax: 847-437-6618  
 Email: [publisher@powertransmission.com](mailto:publisher@powertransmission.com)  
[www.powertransmission.com](http://www.powertransmission.com)

## Zero-Max Innovation & Leadership

For over 60 years, Zero-Max, Inc. has created innovative solutions to motion control problems worldwide. With strategic distribution points located throughout the world, Zero-Max can deliver your motion control solution.

The Zero-Max team of application specialists can engineer a solution to meet your motion control requirements. With many years of application experience Zero-Max excels in these areas:

- Experienced Practical Application Advice
- Responsive to customer needs
- Predictable high quality
- Fast Delivery
- Integrity
- High Value
- ISO 9001: 2008 certified
- Configurable 3D CAD downloads

Zero-Max Primary Product lines include: Shaft Couplings and Torque Limiters for Servomotors, Linear Actuators,



Wind Turbines, Printing Presses, Label Printing, Converting Machines, Machine Tools, Test Equipment, Feedback devices, Packaging Machines, Process Equipment, Dynamometers, and other high performance applications.

Variable Speed Mechanical Drives for Agricultural, Printing, Peristaltic Pumps, Food Processing, Pharmaceutical, Packaging, and many other applications.

Overhung Load Adaptors for Timber processing, Brush Clearing, Road Construction, Marine, and other rugged applications that need overhung load protection for hydraulic pumps and motors.

Keyless Locking Bushings for Packaging, Processing, Tooling, Automated Assembly, and applications that would benefit from the unique qualities of these bushings.

## ZERO-MAX

**FOR MORE INFORMATION**  
 13200 Sixth Avenue North, Plymouth, MN 55441-5509  
 Phone: 763-546-4300  
[www.zero-max.com](http://www.zero-max.com)



# R+W Coupling Technology

## Reliable Connection Elements

**R+W.** Since 1990 the German-based designer and manufacturer of precision couplings for high performance drive systems has strived to offer the best in standard and custom solutions for the most demanding applications. In addition to having readily available zero backlash coupling models in stock in basic economy configurations, R+W is also constantly engineering unique flexible couplings and torque limiters based on specific customer requirements for extreme speed, torque, stiffness and more. The units deployed by R+W include couplings running at speeds in excess of 150,000 rpm, and ball-detent clutches holding loads of over 20 million Nm. Beyond coupling engineering feats, one of the keys to the success of R+W continues to be its adaptability to customer needs.

Some of the more popular developments

in recent years include the CH series of inline and parallel servo motor mounts for linear actuators, the SCL series of servo-rated disc pack couplings for higher misalignment, and the SL series of precision ball-detent torque limiters, available for quick delivery out of R+W America in Illinois. Customers also benefit from USA-based applications engineering offering easy communication and quick turnaround for special designs. Whether for micromotors or multi-megawatt mill drives, R+W has the coupling solutions for almost any situation.

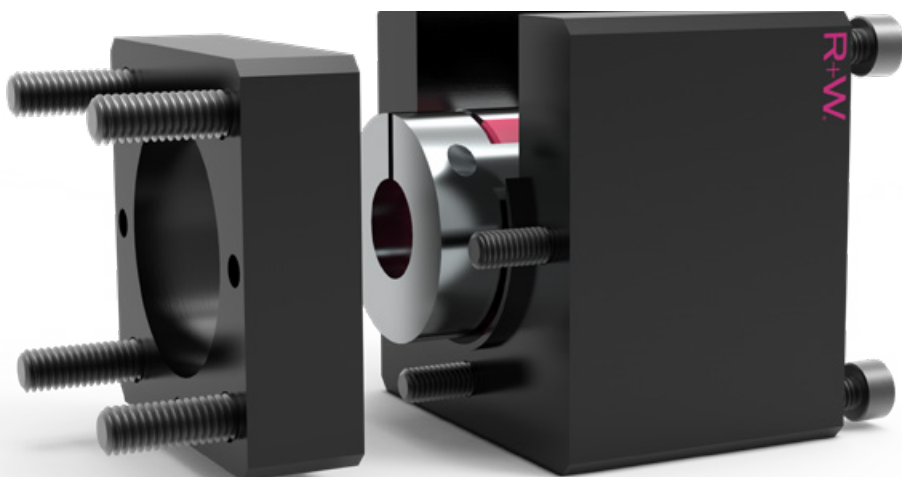

# R+W<sup>®</sup>

A POPPE + POTTHOFF COMPANY

### FOR MORE INFORMATION

254 Tubeway Drive, Carol Stream, IL 60188

Phone: 630-521-9911

Fax: 630-521-0366

Email: [info@rw-america.com](mailto:info@rw-america.com)

[www.rw-america.com](http://www.rw-america.com)

# All the Small Things

Packaging and material handling applications are reaping the benefits of smaller, smarter and more efficient components

Matthew Jaster, Senior Editor

**We begin with a quick shout out to the machine builder.** They are tasked with designing machines that bring value to their customers, offer higher productivity, faster engineering, smarter components and less maintenance. According to Joaquin Ocampo, product manager at Bosch Rexroth, these customers would prefer electric cabinet reduction, fewer connection points, fewer components, faster installation, less wiring, easier testing and faster start of production.

The demands may grow during the design phase with customers asking for capabilities such as IoT connectivity, a faster build cycle and a final request to build a smaller machine that uses less floor space with more functionality than the older equipment currently on the floor. Once the machine builder has provided these capabilities they can typically expect a third itemized list of “additional features,” that need to be added last minute.

Machine design, as it turns out, is not for the faint of heart.

## The Downsizing Directive

My first few years covering gears, bearings, motors, couplings and automation in this magazine could have been called *Super-Size Me*. Shop floor tours and trade shows featured large, versatile machine tools that provided big components for a variety of industries. These large components boasted more power, functionality and technology than smaller versions in applications where harsh environments came with their own set of production challenges.

This ‘bigger is better’ mentality didn’t last very long, however.



Bosch Rexroth's IndraDrive Mi provides cabinet-free drive technology.



Bosch Rexroth's IndraDrive Mi has for years now been working effectively in a wide range of applications that rely on maximum flexibility with minimum space requirements.

A funny thing happened on the way toward the Great Recession circa 2007-2008. The world started scaling back, energy efficiency became a hot topic and ‘less is more’ became the mantra throughout several different manufacturing sectors. This trend has continued—gaining momentum in recent years—with new energy requirements and smart manufacturing solutions.

It's really just a simple mathematical equation at the end of the day.

“Smaller products save on weight and can typically save on the cost of not only one component, but also the components that it interacts with on the machine,” said Jeff Nazzaro, motor and gearhead product manager at Parker Hannifin. “This can create a smaller footprint for the entire machine which would take up less space on the factory floor.”

Chris Moskaites, product manager—electromechanical solutions, Lenze Americas, agrees. “Customers are demanding more flexible machines and shorter development times. To support our OEMs and plant manufacturers, we offer modular and standardized software modules which are particularly important for the packaging industry and machinery standards such as *PackML*.”

## Component Considerations

The factory floor isn't becoming a larger, more complicated mess of machines, personnel and management. On the contrary, we're scaling back, automating equipment and running entire packaging conveyor lines with our smartphones and/or tablets. Today, it's all about keeping it simple.

The challenge in creating a more compact, streamlined production cell is integrating the needed functionality to the equipment without adding extra costs.

“When developing smaller, more compact products, tolerances must be tighter to ensure proper form/fit, which adds costs in design, manufacturing and quality control,” said

Marchelle Forish, product marketing manager, Valves and Valve Systems Americas at Emerson.

“One of the ways Emerson addresses this challenge with R&D investment is with technology-leading tools such as 3D printers. Emerson also focuses on identifying and selecting high-quality, lightweight materials for valves and actuators. In development of AVENTICS brand compact valves, Emerson utilizes high-resistance polymer materials yielding compact sizes but still allowing for equivalent or higher flow and pressures than predecessor series.”

At Parker Hannifin, the challenge lies in fitting the embedded components into the housing as efficiently as possible while allowing the unit to meet thermal and EMI requirements, according to Linda Caron, global product manager for Parker Hannifin. “Ultimately, we want to add as many connectors as we need such as power-out options, optimize the space for functional performance and ensure the power density of the product is not compromised,” she added.

Moskaites at Lenze cites the physical limitations of the equipment and competitive pricing as two areas that pose obstacles. “We overcome these by providing the MF Series motors and our Smart Motor. The MF Series uses special windings, bearings, and seals. Its frame size is up to 2 sizes smaller, while offering more dynamic performance due to its lower inertia. Our Smart Motor is an application specific product for horizontal conveying that allows the customer to significantly reduce the size of their electric cabinet.”

Another challenge using smaller motor-integrated technology is showing how these components go in the machine without a cabinet at all.

“Our organization addresses these challenges by showing the benefits of using cabinet-free technology like the IndraDrive Mi, such as reduced installation effort, energy savings, a simplified design of compact machines, and a reduced complexity and wiring effort,” said Ocampo at Bosch Rexroth.

### Greener and Leaner

The task of creating smaller and smarter components and systems means a greater emphasis on energy efficiency and green manufacturing.

Energy savings of products is a key factor in any new concept developed by Emerson, from the material and component selection to the final design focusing on reduced power consumption of solenoids and reduced pressure losses with optimal spool and valve housing design.

“Emerson strives to minimize material and energy consumption via optimized components and well-controlled processes. With the AVENTICS brand, Emerson provides engineering online tools for pneumatic system optimization and offers a variety of product features (as standard) which help minimize air consumption via reduction of actuator size or reduction of pneumatic pressure,” said Forish.

Parker Hannifin has always considered energy efficiency a staple of its vast product catalog.

“Considering we support the global market with Parker’s new product development we must consider energy consumption, testing, development standards and certification

requirements for many countries,” said Caron. “These will vary by country and by the market vertical served, but are part of our design specification process to ensure maximum market acceptance for all regional areas.”

With the IndraDrive Mi at Bosch Rexroth, the DC bus is shared among drives because the DC voltage, communication, and control voltage run in one cable. The architecture of the IndraDrive Mi is a line topology. “One motor connected to the next motor. If one motor is decelerating and another is accelerating the energy between them is used by the motor that is starting to move. This reduces energy loss and makes the system more efficient. The power supply can be a regen power supply that will put any excess voltage back to the power line,” said Ocampo.

Lenze also considers energy efficiency a large factor in product development. “We focus on the complete customer solution including the efficiency of the motor, gearbox and drive,” said Moskaites.

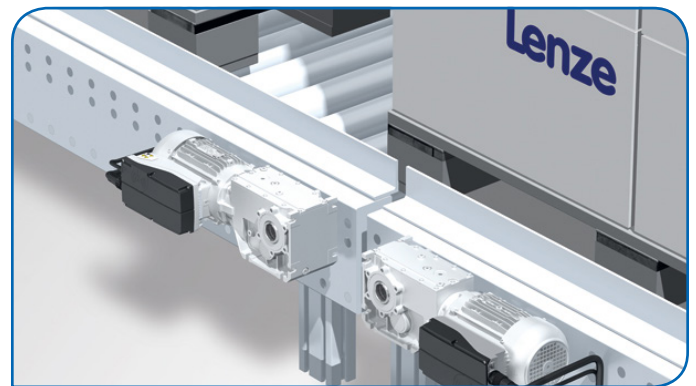

A smart motor drive solution provided by Lenze.

### Smarter Machines

One of the significant changes in factory floor equipment today is the value provided by sensors, real-time monitoring and IIoT in general. It’s easier to scale back on technology when the smaller, compact version provides so much more immediate data.

“The IIoT allows real-time information to drive operations and decision making for the most highly optimized customers. It’s vital the required diagnostic and prognostic data is available as needed and is easy to obtain. Smart intuitive products allow our customers to run highly efficient operations with a just-in-time mentality. It takes some of the traditional troubleshooting and downtime away that in the past created wasted time and inefficiencies,” said Caron.

Moskaites says look no further than day-to-day monitoring capabilities as well as a machine that can detect life expectancy of the equipment. “The IIoT enables machine and plant manufacturers immediately to generate added value. On the basis of real-time data the availability, production performance and quality of the manufacturing process can be improved.”

This means providing real-time information that allows you to act in real-time as well, which means maintenance and repair is faster and OEE is improved, according to Allen

Tubbs, product manager at Bosch Rexroth. “If trends or conditions can be identified in advance, earlier on the failure curve, then action can be taken to prevent the failure thus skipping the downtime resulting from reacting to the failure instead,” Tubbs added.

Nathan Irvine, senior pneumatic application specialist, Americas, at Emerson said that the packaging and material handling industry is pressed to improve throughput and overall efficiency. “Smart manufacturing with real-time data allows for minimization of unexpected downtime via scheduled machine maintenance based on cycle counting, air consumption monitoring and other metrics of the pneumatic system, including, for example, monitoring shock absorber conditions in high-impact applications,” he said.



Parker frameless motors cut down on size and cost of packaging and material handling equipment.

## The New Factory Floor

The Industry 4.0/IIoT platform is transforming the look and feel of the factory floor. It's forcing machine builders and product designers to look at the space differently. Caron at Parker said that pneumatics have become much smarter in the Industry 4.0 space. It has forced manufacturers to rethink design. How can we add communications, connectivity, diagnostics, and prognostics and make it easy for the customer while reducing weight, space and cost from traditional product design?

Tubbs at Bosch said that software is playing a bigger part of the equation and pulling data off of machinery has never been software-friendly. “New product must communicate efficiently as part of their standard function. But we focus on creating solutions to harvest data off older machinery as well. Both new and old exist in every plant and you need data from both to have a complete picture.”

Factory floors are becoming more automated and more IIoT-ready, according to Forish at Emerson. “We are investing in IIoT-ready pneumatics to provide an enhanced layer of sensors and component performance data to enable

implementing these concepts.

She goes on to discuss the costs involved.

“Packaging and material handling costs are relevant. Emerson is constantly looking into possibilities to reduce packaging costs by using new materials, reducing package sizes and evaluating new machines and equipment to automate,” she added.

For Moskaites, the factory floor is changing because customers are demanding more capabilities. “Customers are also looking for ways to have increased control, but reduced effort in design, installation, and maintenance. Workforce shortages force our customers to look for solutions that are easier to implement. These factors play a large role in our product development efforts today.”

## Handheld Technology

These development efforts include a greater emphasis on mobile technology. Lenze, for example, continues to build on its Blue/Green Solutions platform which analyzes system consumption between different possible combinations. “Our most recent geared motor combination uses smartphone technology to program acceleration time and switch to Eco-mode as needed,” said Moskaites.

Emerson implements QR codes on AVENTICS brand product to allow customers to easily scan with a smartphone or tablet and have immediate access to all documentation for that product.

“Emerson's new CAT tool designed to measure pneumatic cylinder speed and cushion connects to smartphones via Bluetooth, allowing users to evaluate the deceleration curve on the spot of a cylinder. By adjusting the cushion screw on the cylinder, the overall cylinder speed and optimal/ideal cushion can be achieved. The final effect is reduced cycle time, improving the OEE of the machine,” said Franco Stephan at Emerson.

Bosch is always looking for ways to make data more accessible and transparent. “Part of that is creating ways to use standard data devices, like phones and tablets that everyone has in their pocket, to view and even collect data for quick and efficient analysis. This is leading us to implement web-servers in most of our products. This provides access through any standard web-browser, eliminating the need for special software or even specific apps to do diagnostics,” said Tubbs.

Caron at Parker added that access to embedded webpages that are easily accessible or remote access to diagnostic data is important to their customers. Remote access is often required where equipment is embedded into a machine or operating in a remote area.

## The Next Wave of Products

The future of product development is hard to predict due to the changing market needs and the evolution of standards, all of our interview subjects will continue to embed smart functionality into their designs.

“Expect to see more network-based products and embedded safety components that are tamper proof,” Caron said.

The cabinet-free technology IndraDrive Mi, will be a part of smaller machines in the years to come, according

to Ocampo. “Machine builders will realize the needs of the market and the consumers and will find way to manufacture machines that are flexible and can be modified faster.”

Along with the trend toward more IIoT-enabled devices, Forish at Emerson said there will be greater use of wireless technology in packaging and material handling operating environments.

“New investments in software development and easy-to-access platforms to visualize machine performance on demand will be in greater and greater demand, which is why the AVENTICS brand by Emerson is focused on advancing smart pneumatics,” she said.

Forish also sees momentum growing toward standardization across all automated manufacturing to certain communication protocols and data collection platforms; this standardization is essential to accomplishing the vision of cloud-based IIoT manufacturing that has all components connected and communicating in real time, with smarter

analytics that enable new levels of productivity and flexibility in manufacturing.

Smaller, faster, and more flexible components appear to be the future. Now is as good a time as any to start thinking about how these trends may influence product design decisions moving forward. **PTE**

#### For more information:

AVENTICS (Emerson)  
Phone: (859) 259-3855  
[www.aventics.com](http://www.aventics.com)

Bosch Rexroth  
Phone: (800) 739-7684  
[www.boschrexroth-us.com](http://www.boschrexroth-us.com)

Lenze Americas  
Phone: (508) 278-9100  
[www.lenze.com](http://www.lenze.com)

Parker Hannifin  
Phone: (800) 272-7537  
[www.parker.com](http://www.parker.com)

For Related Articles Search

packaging

at [www.powertransmission.com](http://www.powertransmission.com)

## Compact Requirements

With smaller, more efficient solutions in mind, *PTE* asked our interview subjects to describe a recent engineering challenge they helped solve for their customers. Here’s a brief rundown of some of the technologies they provided.

### AVENTICS (Emerson)

A customer needed a small, compact, lightweight valve system to mount directly on mobile aggregate application equipment. With Emerson’s AVENTICS Series AV valve system, the customer eliminated 96 pneumatic components, 24 DIN electrical connectors, 24 terminal blocks, reduced the size of the electrical cabinet and reduced wiring and debug time, according to Forish.

“In another example, a customer required a very compact valve unit for an OEM application; this custom product was the basis for Emerson developing a new polymer valve manifold utilizing the AVENTICS cartridge valve and providing the smallest footprint while maintaining the flow levels this application demanded,” Forish said.

### Bosch Rexroth

Machines with many axes can be a challenge for machine builders. An application that requires a total of 30 axis will have at least 60 cables from the cabinet to the machine—one cable for the motor feedback and one cable for the motor power. This is a lot of cable management, and a lot of connection points that can be loose or even not connected and cause startup challenges. In addition, the size of the cabinet and the AC unit to cool the units are significantly big. The weight of the machine is a challenge when it comes to shipping costs. The footprint of the machine also incurs costs when shipping.

“With the IndraDrive Mi, the motors are mounted on the machine and the cable management is much leaner. In-

stead of 60 cables coming out of the cabinet the application will only need four cables. The cabinet is reduced by 90% and the cable cost, labor cost, shipping cost, and weight are reduced considerably,” Ocampo said.

### Lenze Americas

“Recently, our customer’s application demanded faster acceleration and greater inertia/speed control. Our approach was to start with a complete sizing and evaluation of the application using our design software. Our MF motor solved both criteria, while being more compact overall,” said Moskaites.

### Parker Hannifin

Nazzaro at Parker said that the company was recently asked to provide a high-torque motor, with feedback device and brake, within a very small envelope as well as keeping weight to a minimum. “The solution was the design of a highly efficient motor which kept overall diameter and length as small as possible. A unique design had the brake assembly enveloped within the inner diameter and length of the motor. This innovation allowed us to meet the customer’s requirement which led to us winning the business,” he said.

In another example, Parker was asked to provide a network interface to Industrial Ethernet for a valve manifold that was more compact than the traditional off-the-shelf solution currently available. “With the help of 3D printing, we were able to quickly prototype a solution that will become a new design for other customers to also utilize. We were thrilled with the quick turnaround from engineering and the end result was a very clean looking, compact space saver!” Caron said. **PTE**

# Adapt, Embrace and Innovate at Pack Expo 2019

Matthew Jaster, Senior Editor

Pack Expo Las Vegas (Sept. 23–25; Las Vegas Convention Center), co-located with Healthcare Packaging EXPO, showcases the latest packaging technologies to help manufacturers improve operations and stay competitive.

The show brings together 2,000 exhibitors and 30,000 attendees over 900,000 net square feet of exhibit space from 40+ vertical industry markets and nearly 130 countries.

## Trade Show Talent

PTE magazine recently caught up with [Laura Thompson](#) who began as the PMMI receptionist 20 years ago, fresh out of Baylor University. She received her first taste of the show department as the international expositions coordinator before a brief stint in global marketing organizing international pavilions for PMMI members at both PMMI and non-PMMI events.



When PMMI took over sole ownership of Expo Pack México, Thompson moved back into the show department managing the PMMI Pavilion and all show operations for the largest packaging and processing event in Latin America.

Upon her promotion to director of trade show operations, all operations in the Pack Expo portfolio of trade shows became her responsibility. As Thompson's role expanded to the overall management of the Pack Expo portfolio of events as well as PMMI's contracting business Pack Expo Services (PES), she was promoted to senior director, expositions. Thompson has had responsibility for the operations of all Pack Expo events in the U.S. and Mexico, and helped lead the successful launch of three new shows: Expo Pack Guadalajara, Pack Expo East and ProFood Tech. In April 2019, Thompson was promoted to vice president, trade shows.

## New for 2019

This year's show will include never-before-seen features that will connect visitors with the latest robotics technology, showcase suppliers' innovative solutions and provide opportunities to meet with students and veterans exploring careers in packaging and processing. Here's a rundown of some of the new features, technologies and presentations available at this year's show:

The Robotics Zone debuts in Las Vegas, featuring the latest advancements in industrial robots, with live demonstrations of artificial intelligence, end-of-arm tools, collaborative robots (cobots) and pick and place/relocation activities, including:



- Object Detection and Flexible Grasping with Artificial Intelligence Demo sponsored by Siemens Digital Industries US
- Comau's Interactive Wearable Exoskeleton, allowing attendees to try on a wearable suit and perform assisted tasks and product handling
- Soft Robotics' End-Of-Arm Tool Exhibit, demonstrating an end-of-arm tool designed to mimic the human hand to grasp and manipulate items that vary in size, shape, and weight
- The KUKA Robotic Pianist live in concert
- The Ready Robotics Bowling Robot
- Pick and Place/Relocation activities in action, compliments of the University of Waterloo and Septimatech Autonomous Robot
- Omron Greeter Robot
- PACK for a Purpose: Robots Fighting Hunger, robots will be packing food into backpacks to feed children on the weekends, in collaboration with Blessings in a Backpack. Exhibitors Bosch Packaging Technology, Inc., Chicago Electric, FANUC America, ProMach Performance Services with ABB, Soft Robotics, and Cognex and Universal Robots in partnership with Allied Technology will supply robots for this cause.

The industrial robot market in the Americas was estimated to be \$3.5 billion in 2017, with the U.S. accounting for more than 70 percent of sales, according to PMMI's whitepaper Industrial Robot Opportunities in Food and Beverage Processing.

"Also new in 2019, the first Technology Excellence Awards will recognize exhibitors' innovative technologies being shown for the first time at Pack Expo Las Vegas and Healthcare Packaging Expo. All registered attendees will be able to vote during the show on their favorites among the finalists selected in specific market segments," said Thompson.

Finally, CareerLink, PMMI's online job board, is going live for the first time at Pack Expo Las Vegas and Healthcare Packaging Expo in 2019. CareerLink LIVE @ Pack Expo is an opportunity for PMMI, CPA, The Association for Contract Packagers and Manufacturers, Institute of Packaging Professionals (IoPP) members and consumer packaged goods (CPG) companies to conduct one-on-one, on-site interviews with students and veterans pursuing careers in packaging and processing.

### Smart Packaging

PMMI's 2019 Flexible Packaging Marketing Assessment reports that the U.S. flexible packaging market witnessed accelerated growth of 61 percent from 2000 through 2017. The market is expected to continue to expand in almost all categories and will continue to increase at a 3.1 percent CAGR through 2023, reaching a market size of \$391.6 billion USD.

"This growth is driven by both consumer preferences for convenient packaging and industry demands for sustainable and consumer-friendly packages. Food remains the largest end-use industry for flexible packaging, and two segments—processed food and vegetables and baby food—are expected to outperform the overall food market through 2023," said Thompson.

"The report also notes that key technology developments, like intelligent packaging, continue to support packaging growth across a broad variety of manufacturing segments. Active and intelligent packaging through RFIDs and smart labels can be used to identify product location. RFID labels, which are easy to add to most flexible packaging could diminish the number of stolen items and allows for cashier-less stores like the one Amazon is opening," she added.

By implementing RFID within its flexible packaging, companies can scan and obtain data for all inventory items immediately across the entire value chain. The constant need to monitor the state of goods is fueling the growing popularity of sensors being used to track temperature and quality, especially in the food, beverage and pharmaceutical industries. 2D barcodes are also a major opportunity within smart packaging and is being enforced by serialization laws, Thompson said.

Pack Expo Las Vegas attendees can find the flexible and smart packaging solutions to suit their needs in industry-specific pavilions. The PACKage Printing Pavilion in the Central Hall will focus on the advantages of digital printing, showcasing the latest in cost-effective solutions for smart packaging, as well as short-run, on-demand, cost-effective, variable data and personalized packaging. The Reusable Packaging Pavilion, sponsored by the Reusable Packaging

Association (RPA) and located in the Upper South Hall, will showcase sustainable packaging solutions, to help reduce waste, cut costs and gain chain efficiency.

The Containers and Materials Pavilion in the Lower South Hall will showcase the latest innovations in flexible, resalable, paperboard, glass, metal and plastic packaging as well as containers and materials. The Showcase of Packaging Innovations, sponsored by Dow, is located within The Containers and Materials Pavilion and will display award-nominated, creative packaging solutions.

"Attendees can also join educational sessions on smart and flexible packaging presented by exhibitors at the Innovation Stage in the Central Hall. This year's presentations will include insights on sustainability in flexible packaging, films, gas permeability and smart packaging advances. Sessions are free and open to all attendees," Thompson said.

### Mobility and Automation

Thompson believes automation in the packaging industry is at a pivotal juncture. New technology is available and underway, and there is a competitive demand to adopt technology on the plant floor to obtain flexible and efficient operations. According to PMMI's 2017 report The Evolution of Automation, 69 percent of end users forecast increasing capital spending budgets, and some have a dedicated budget for automation. Automation on the plant floor is being driven by lack of skilled labor and labor shortages, global increase in product demand, flexible manufacturing, demand for consistent quality products, overall operating cost reductions and smart machine technology and cobots.

"Packaging operations are embracing automation in case tray handling machinery. With the increase in the number of case shapes and sizes, the reduced thickness of the material, and the need for unblemished end products, automation is being used to ensure smooth acceleration and precise movements throughout the packaging process. Automated machinery is also being used in form, fill and seal, with advancements including servo-driven jaws and vacuum belts for sealing applications," Thompson said.

### Sustainability and Energy Efficiency

Sustainability and energy efficiency have become an integral part of packaging industry due to consumer demand and game-changing trends like the heightening demand for organic products and rapid growth of online retail. The push for more recyclable materials in packaging is leading to creative developments like a recyclable bottle made of paper.

Demand for ready to eat or convenience foods and sustainability trends have helped to bring about a recent surge in polypropylene demand. Benefits of using polypropylene include its lightweight, clarity (allowing customers to see through to the product), affordability, sustainability and resistance to high and low temperature, such as that in a microwave oven or a freezer, while maintaining freshness and durability. As this material satisfies many current consumer and manufacturer packaging concerns, it is expected that demand for polypropylene packaging will increase and potentially take share from PET in food packaging applications, according to

PMMI's State of the Industry 2018 report.

"Sustainability concerns have also helped to drive other changes such as cap size reduction, use of lighter materials and reduced label thickness and material waste. To enable this, OEMs are making efforts to ensure that machines can handle thinner materials and optimize material usage. This will reduce material consumption and therefore product weight, ultimately reducing material and transportation costs," Thompson said.

Demand for sustainable packaging is pushing flexibility in case handling machinery as end users are looking for the flexibility to handle both non-recycled and recycled materials in with the same machine. "Additionally, sustainability is driving demand for non-heated adhesive application machinery, which eliminates the need for heat by using adhesives such as foam, ultimately saving energy and increasing safety. The amount of material being used in packaging operations is also being optimized to reduce waste while maintaining the integrity of the case," she added.

### Robotics

For Thompson, robotics is no longer just a tool; it is a force in the industry driving a revolution of change in manufacturing. Improved vision sensors have allowed robots to become more accurate when picking objects, safer when operating around humans and more consistent in their ability to reject faulty products. Robots are also becoming more affordable and simpler to operate. PMMI's 2019 Robotics Innovation 2 Implementation Report found that 70 percent of OEMs interviewed predicted increasing the use of robotics on their machines to meet the application demands of end users. OEMs adopting robotics can expect to achieve increased speed and throughput, reduction in labor costs, improved product quality, more flexible manufacturing and improved worker safety.

"Cobots are some of the newest tools available to companies of all sizes—they are compact, moveable and affordable. Although traditional robot adoption is more widespread, cobots will find their niche along the line for simple, slow motion applications and for reducing repetitive tasks, like pick and place, assembly, dispensing, loading and unloading. Cobots can also be used in secondary packaging applications like carton loading, case packing, case sealing, retail ready, tray unloading and variety packing/bundling," Thompson said.

Some of the cobot products and devices currently on the market are not able to fully meet all the requirements expected of safe human-robot collaboration. The development of new sensor and robotic technologies, like capacitive skins that react to contact, along with intelligent control systems, is fundamental for future cobot applications. Robot software is becoming easier to manage for most commonly used robots, especially cobots, but it can still be a challenge, and the lack of skilled workers to operate robotic machinery is top of mind across the industry.

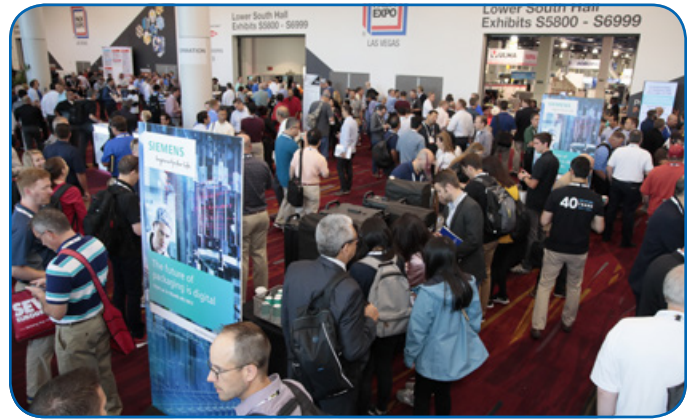

### Additional Highlights

As augmented reality (AR) and virtual reality (VR) technology advances, companies can leverage data to develop packages that will catch consumer attention. Clemson University's Data Driven Packaging Design exhibit in the Upper South Hall will provide insight on real-time consumer preferences from Clemson's eye tracking study; dive into AR/VR demonstrations and test live emotional analytics.

Thompson said that the packaging industry, like other manufacturing industries, is facing a shortage of skilled labor to operate advanced machinery. The Workforce Development Pavilion is PACK EXPO Las Vegas' one-stop-shop for resources to strengthen the current workforce and grow the existing workforce. Visitors will learn about PMMI U offerings, including training workshops. Schools will present mechatronics, packaging and processing offerings, and you can meet students interested in careers in the industry. "PMMI is also offering training workshops in Las Vegas to coincide with Pack Expo Las Vegas. Attendees can join a risk assessment workshop, a certified trainer workshop and a fundamentals of field service session," she said.

### Packaging Evolution

The Pack Expo portfolio of trade shows is constantly evolving to meet changing industry needs and provide solutions for new challenges.

"With the introduction of the Packaging & Processing Women's Leadership Network (PPWLN) Breakfast, Pack Expo Las Vegas offers attendees the opportunity to hear from women leaders in the industry and connect with peers through networking exercises and shared experiences. Ellen Ochoa, the first Hispanic woman ever to go to space, is the keynote speaker at PMMI's PPWLN breakfast taking place during Pack Expo Las Vegas. The latest in a series of networking events, this year's theme Exploring New Territory, will shine a spotlight on Ochoa—who, in addition to her four space missions, is only the second female Director of NASA's Johnson Space Center where she led the human space flight enterprise for the nation from 2013 to 2018. The breakfast will take place on Tuesday, Sept. 24, 2019 at 7:30 a.m." Thompson said. **PTE**

### For more information

Pack Expo  
Phone: (571) 612-3200  
[www.packexpolasvegas.com](http://www.packexpolasvegas.com)





## Engineering sMart

is your resource for the latest in great ideas from our advertisers. Check this section every issue for sMart Engineering ideas and technology.

For information about advertising, contact  
Dave Friedman  
at

(847) 437-6604

or

[dave@powertransmission.com](mailto:dave@powertransmission.com).

## Helical Worm Speed Reducers

Our helical worm gearmotors and speed reducers provide unmatched performance, durability, and design flexibility.



- 6 sizes, fractional to 10 HP
- Multi-stage Ratios
- NEMA, IEC, or Servo Motor Adapters
- Low Backlash & Efficiency up to 90%
- Multiple Mounting Configurations

**DIEQUA**  
Corporation

[diequa.com/pte](http://diequa.com/pte) 800-280-5402

## Inline Helical Speed Reducers

An extremely compact design provides highly reliable, space saving performance for the most demanding applications.



- 14 sizes, 1 - 75 HP
- Multi-stage Ratios
- NEMA, IEC, or Servo Motor Adapters
- High Efficiency & Low Backlash
- Multiple Mounting Configurations

**DIEQUA**  
Corporation

[diequa.com/pte](http://diequa.com/pte) 800-280-5402



**B&R**  
MACHINE AND GEAR CORP

**BRGEAR.COM**

## ASK-THE-EXPERT LIVE!

**ASK the EXPERT LIVE** is coming to MPT Expo 2019 in Detroit, MI.

This is your chance to have your questions answered in person by our live panel of experts.

**Gear Manufacturing, Tuesday, Oct 15, 10:30 a.m.**

**Gear Design, Tuesday, Oct 15, 2:30 p.m.**

**Lubrication, Wednesday, Oct 16, 10:30 a.m.**

**Bearings, Wednesday, Oct 16, 2:30 p.m.**

**Can't wait?** Submit your question now! Send it by e-mail to Senior Editor Jack McGuinn ([jmcguinn@geartechnology.com](mailto:jmcguinn@geartechnology.com)) and we'll submit it to our experts.

**Power Transmission Engineering**  
**gear**  
TECHNOLOGY



**JW WINCO®**  
A Ganter Company

## Standard Parts. Winco.

### Pneumatic Fastening Clamps

- High Clamping Forces
- Small Dimensions
- Reduced Air Consumption
- Lightweight
- Easy to Use



**J.W. Winco, Inc.**  
Phone 800-877-8351  
Email [sales@jwwinco.com](mailto:sales@jwwinco.com)  
[www.jwwinco.com](http://www.jwwinco.com)

Explore our full product line online or contact us with your application requirements.

  
**Nordex®**  
INCORPORATED

[Nordex.com](http://Nordex.com) [Sales@nordex.com](mailto:Sales@nordex.com) [Eng@nordex.com](mailto:Eng@nordex.com)

Phone: (800) 243-0986  
or Call: (203) 775-4877

*Made to Print Parts*

*Gears, Pulleys & Racks*



*Assemblies*

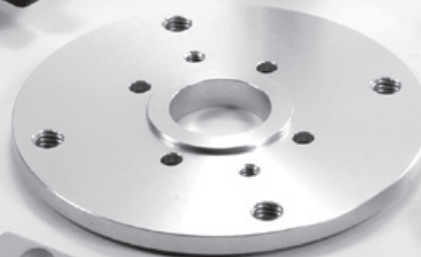

*Standard Components*



*Design & Engineering*



# JRW - Worm Gear Unit

Local Inventory

Same Day Delivery



[www.jie-drives.com](http://www.jie-drives.com)

[Info@jie-drives.com](mailto:Info@jie-drives.com)

630 580 9986

493 Mission St. Carol Stream IL 60188

# Lubrication of Plastic Worm Gears

A. Bormuth, J. Zuleeg, C. Schmitz, R. Schmitz, M. Pfadt and H. Meven

## Introduction

In the selection of lubricating greases for plastic worm gears, the user needs to know the influence of each grease constituent on the tribological performance in order to choose the appropriate lubricant. In this work, the effect of NLGI class, viscosity, baseoil and thickener type are investigated separately regarding the efficiency and temperature close to the tribo contact. With the help of this contribution the user understands the effect of each parameter and learns about the potentially reachable efficiency and temperature ranges.

Polymers are becoming ever more important in today's industrial applications. Especially in actuators, plastics are increasingly applied and substituting metal/metal contacts with plastic/metal or plastic/plastic contacts. Concerning lubrication of plastic worm gears, one has to take the specific material properties of polymers into account. Concepts and data for lubrication of pure metal worm gears cannot simply be transferred, due to two main causes. On the one hand, polymer and lubricant might interact, which could lead to aging of the polymer and result, for example, in softening, embrittlement, environmental stress cracks, and other material changes. These processes are considered within the field of polymer compatibility, which is discussed in a preceding publication (Ref. 1) and therefore is not part of this contribution. On the other hand, plastics are visco-elastic materials, exhibiting pronounced non-linear temperature dependence of mechanical and tribological properties (Ref. 2). In addition, plastic properties also change with frequency, sliding speed, pressure, humidity, wetting behavior and other parameters. These dependencies have to be considered during the design of a gear. Although some of these parameters are discussed in the literature (Refs. 3–5), comprehensive studies on lubricated plastic worm gears remain scarce. In particular, systematic investigations on the influence of the lubricant on the gear performance are limited or incomplete. In this presentation we focus on grease-lubricated small gears comprised of a steel worm driving a polyamide gear

wheel under various loads. Test rig, measurement procedure and the model greases used are described in the next section.

Greases are comprised of three components: baseoil, thickener and additives. The baseoil (if needed, may be a blend of various oils) is fulfilling the basic requirement of each lubricant, resulting in the separation of sliding surfaces by generating a hydrodynamic film. The thickener — usually a soap or a polymer powder — is added to adjust the consistency, thus reducing the flowability of the lubricant and equipping it with the possibility to stay at the place where initially applied. Therefore the thickener often is also called “consistence enhancer” and the consistency of a grease is described by its NLGI number (Ref. 6), which classifies nine different grades, ranging from 000 to 6; i.e. — the higher the number, the firmer the grease. Additives finally are added to ensure specific features; e.g. — corrosion inhibition, reduced aging of the oil or simply color. The greases used in the present study are model greases without additives and are listed in Table 1 at the end of this paper.

The effect of the different grease constituents on the performance of the plastic worm gear is evaluated consecutively. Starting with an inspection of thickener concentration, we switch to baseoil viscosity, then evaluate the effect of baseoil type, and finally examine the influence of thickener type. In the final section we draw conclusions and provide an outlook.

## Test Procedure

As described in the previous section, we focus on a small worm gear comprised of a cylindrical steel worm driving a helically toothed gear wheel comprised of polyamide PA66. The worm is driven by an electric engine and the input torque is measured via a torque sensor. The gear wheel is connected to a brake, whereby a sensor on the output shaft is measuring the transmitted torque. The temperature of the worm is measured close to the tribological contact. A constant grease amount corresponding to tooth filling is applied on the gear wheel. The gear is located within a temperature chamber, so

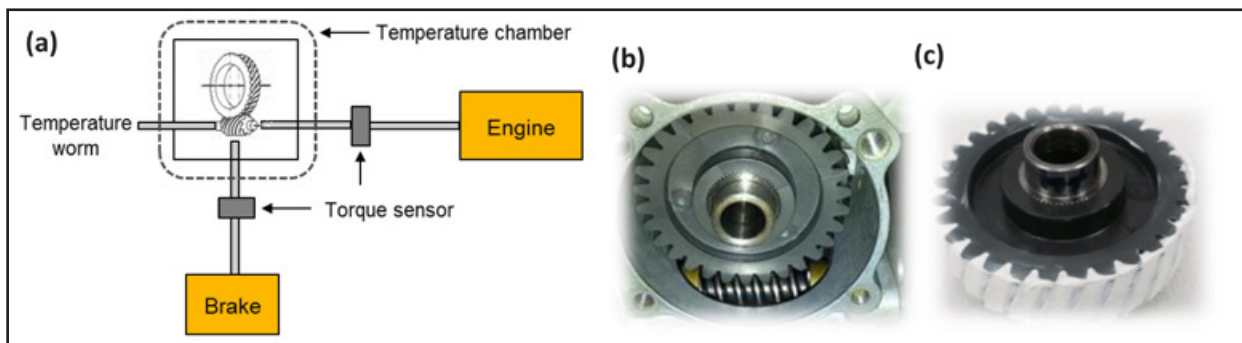

Figure 1 (a) Working principle of the small worm gear test rig used in this contribution. (b) Insight into the tribological contact. (c) Lubricated gear wheel.

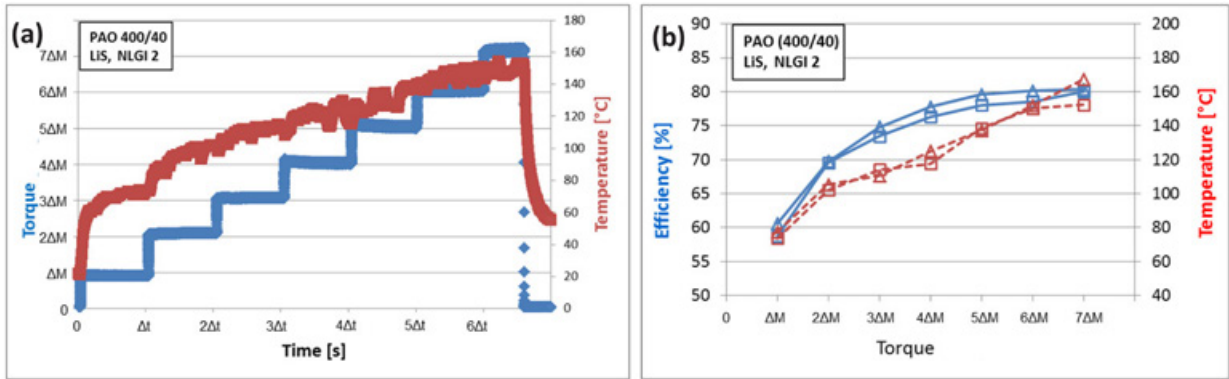

Figure 2 (a) Example of the time-resolved raw data received from the load step test. Torque shown refers to output i.e. on the brake. (b) Result data obtained after time averaging process for two tests with the same grease.

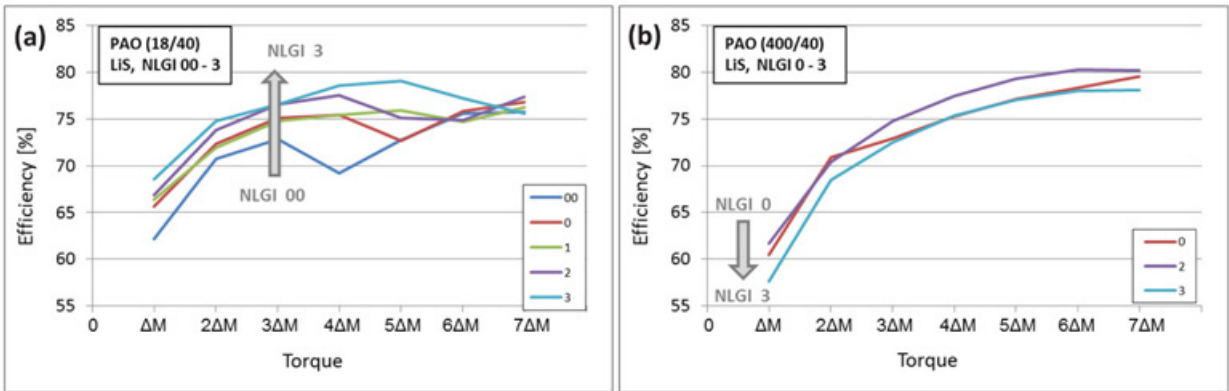

Figure 3 Efficiency as function of the torque for various thickener contents, i.e. NLGI class. Thickener is Li-soap. Baseoil is PAO with (a) low viscosity and (b) high viscosity respectively.

the ambient temperature can be controlled and is fixed to room temperature. Pictures of the test rig, as well as a sketch of the working principle, are presented (Fig. 1).

To investigate the gear performance under constant velocity and various loads, we successively increase the torque in discrete steps  $\Delta M$  every time periode  $\Delta t$ , as shown (Figure 2(a)). Exploiting Equation 1, we calculate the efficiency  $\eta$ , using the input torque  $M_{in}$ , the output torque  $M_{out}$  and the gear ratio  $i$ .

$$\eta = \frac{M_{in}}{M_{out} \cdot i} \quad (1)$$

The time-resolved raw data is used to calculate the average efficiency for each load step. Regarding the temperature, only the last 10% data points are used to calculate an average final temperature for every load step. The average efficiency and final temperature as a function of the load, i.e. — output torque — are depicted (Fig. 2(b)). One can easily see the efficiency increase for higher loads, which is a result of multiple facts. First, the friction coefficient of visco-elastic materials is decreasing with increasing load, due to a non-linear dependence of the real contact area; for instance, as described by Bartenev et al (Ref.7). Second, the contribution of losses occurring, for example, within the bearings becomes progressively negligible. Third, the rheological properties of the grease and, in consequence, the lubricating film formation depend on shear stress and temperature c.f. (Refs.8–9). The temperature measured close to the tribological contact increases monotonically with the torque transmitted,

reaching values around 160°C and above at the final load step. Under such severe conditions, the polyamide should be used only temporarily. Investigations of the reproducibility of the method show a statistical error of approximately 1–2% in efficiency, as can be seen when comparing the two identical tests presented (Fig. 2(b)). In the following, we always conduct at least two tests, and consider the average values.

### Effect of Thickener Concentration

Consistency is one of the most prominent properties of a grease an user inevitably experiences; for example, while applying the lubricant. Hence, this section aims to elucidate the effect of consistency — meaning concentration of the thickener — on efficiency and temperature. Therefore, we start with a low viscosity PAO (18/40) thickened by a Li-soap (i.e. greases No.1–5). The NLGI class of the greases used ranges from 00 to 3. Efficiency data is shown (Fig. 3(a)) as a function of the output torque. With increasing consistency (i.e. NLGI class) the efficiency turns out to increase also. This finding we attribute to a synergistic effect of the thickener to the lubricant film formation. Whereas the low viscous baseoil by itself is not capable to fully separate the sliding surfaces, the thickener molecules also contribute to the load carrying capacity of the lubricant.

Now we chose a high viscosity PAO (400/40) as baseoil, whereas the thickener system is kept constant using the Li-soap (i.e. — greases No.7–9). Corresponding efficiency data is presented (Fig. 3(b)). Here the influence of consistency is less pronounced, and furthermore seems to be contrary to

the observation for low viscous PAO greases. The decrease of efficiency with increasing consistency found for the high viscous PAO is easy to understand when assuming that the baseoil by itself is capable of building up a stable lubricating film separating both surfaces. Then the contribution of the thickener to the load carrying capacity is significantly reduced, in addition the internal friction caused by shearing the grease increases the firmer the grease gets.

Comparing efficiency for the low torque regime for the two different PAO-based greases, one finds PAO (18/40) to exhibit higher efficiency values than PAO (400/40). Regarding the high torque regime, the PAO (400/40) greases show better efficiency. This effect is investigated more deeply in the next section. At the end of this section, we regard the temperature close to the tribo-contact shown in Fig. 4. As anticipated from the efficiency curves, the high viscous baseoil greases show a higher temperature than the ones with the low viscous baseoil. In case of high torques the situation is reversed, there the high viscous baseoil greases exhibit lower temperatures. It therefore can be concluded that, depending on the operating conditions 5% (high torque) to 10% (low torque) in efficiency can be gained by choosing the right consistency and baseoil viscosity of the grease. Furthermore temperature can be reduced at least by 20°C, permitting an extended operation under high loads.

### Effect of Baseoil Viscosity

In this section we investigate the influence of baseoil viscosity more deeply than in the previous section. Therefore we focus on Li-soap thickened PAO based greases with NLGI 2 (i.e. — greases No. 4, 6, 8). In Figure 5(a), efficiency values of the corresponding greases are depicted. It clearly can be seen that for low torques, efficiency decreases with increasing baseoil viscosity. Starting from  $\eta \sim 67\%$  for PAO (18/40) efficiency declines to  $\eta 59\%$  for PAO (400/40). We ascribe this observation to rising internal friction within the lubricating film. Inspecting the load dependence of efficiency, we now regard the high torque regime. Here we find a reversed order compared to the low torque regime. In detail PAO (18/40) exhibits  $\eta \sim 75\%$ , whereby PAO (400/40) shows  $\eta \sim 80\%$ . In case of high loads the lubricating film is assumed to break down for the low viscous oil, for example efficiency starts to break down around  $4 \Delta M$ . The high viscous oil is able to maintain a stable lubricating film, capable of separating the sliding surfaces for all loads inspected; thus no drop or kink in efficiency is observed.

Since dissipation leads to heat generation, the discussed behavior of efficiency reflects fairly well in the temperature curves shown in Fig. 5(b). Attention here has to be focused on the high torque regime, since there temperature is reaching up to 180°C for the low viscous oil; hence the system should run only temporarily under such severe conditions.

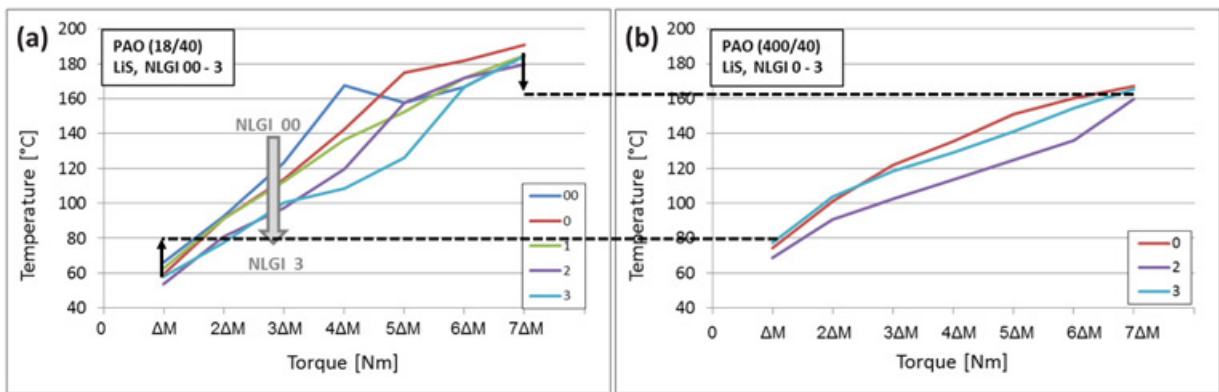

Figure 4 Temperature as function of the torque for various thickener contents, i.e. NLGI class. Thickener is Li-soap. Baseoil is PAO with (a) low viscosity and (b) high viscosity, respectively.

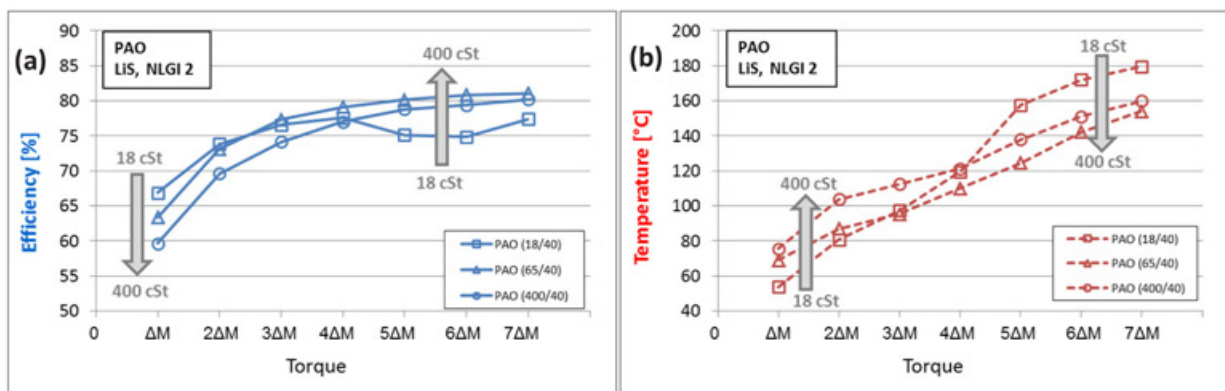

Figure 5 Data for (a) Efficiency and (b) Temperature as a function of the torque for PAO greases with various baseoil viscosity. All three greases are Li-soaps with NLGI 2.

## Effect of Baseoil Type

There is a broad variety of different molecules available to be used as baseoils. Chemically, most of these can be grouped into polyalphaolefins PAO, polyalkylene glycols PAG, mineral oils and esters. Within this section, we investigate the influence of the mentioned baseoil chemistry on the gear performance. Therefore, we select Li-soaps with NLGI 2 (i.e. — greases No.4, 6, 8, 10, 11–13). The corresponding efficiency data are given (Fig. 6). The behavior of the three PAO based greases were already discussed in the previous section; so we will not discuss the viscosity dependence of the polyalphaolefins again, as data are plotted for completeness.

At vast overview, efficiency turns out to be more sensitive to baseoil chemistry in the low-torque region than in the high-torque limit. Comparing the low viscous PAO (18/40) to the low viscous PAG (30/40), for small loads both perform almost similarly. For high loads, the PAG turns out to maintain its lubrication capability, whereby the PAO drops down. Furthermore, if one regards the two different polyalkylene glycols PAG (30/40) and PAG (360/40), the former shows superior performance for low torques, while exhibiting

identical efficiency values for high loads. Finally, the ester (73/40) stands out, showing high efficiency over the whole torque spectrum.

At the end of this section we clearly want to point out that the selection of a baseoil cannot be made on the basis of tribological data alone. Moreover, polymer/lubricant compatibility (Ref. 1) and thermal stability of the oils (and mostly many other requirements) must be considered. Mineral oils, for example, in many cases are ruled out due to their low thermal stability.

## Effect of Thickener Type

The goal of thickeners is to give the lubricating oil the feature to stay at the applied place by reducing its flowability. In most cases, soaps are used, but there are also other possibilities available; e.g. — using a polymer powder. In this section the influence of the thickener system is examined by investigating PAO baseoils thickened with a Li-soap or PTFE power to NLGI 2 (i.e. — greases No. 4,6,8,14–16). Respective data for efficiency and temperature is depicted (Fig. 7). In general we find PTFE greases to exhibit higher efficiency and thus show

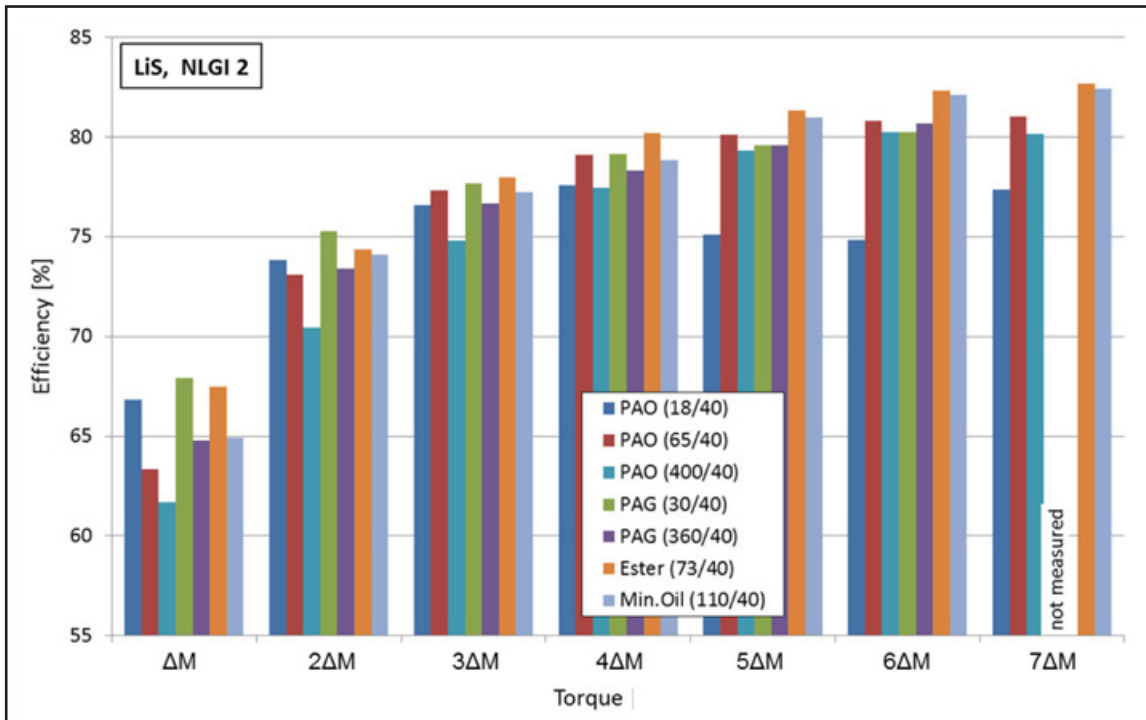

Figure 6 Efficiency as a function of Torque for greases with chemically different baseoils. All greases are Li-soaps with NLGI 2.

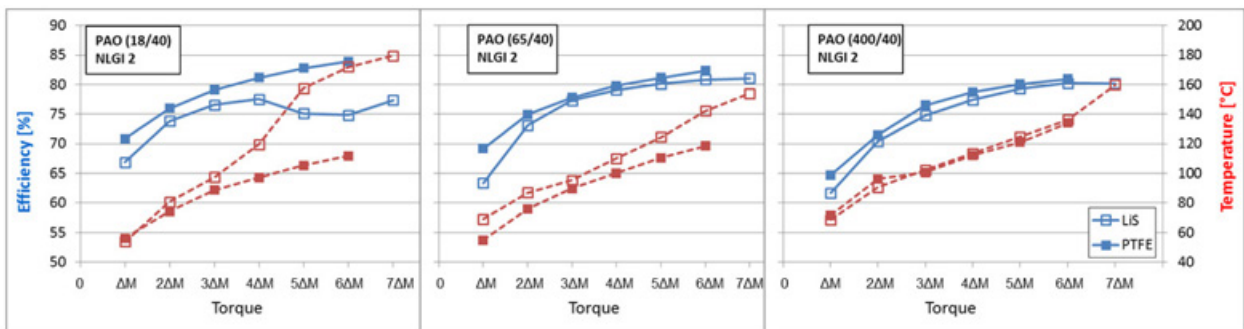

Figure 7 Efficiency and Temperature as a function of Torque for greases with PAO baseoil and NLGI2. As thickener Li-soap (open symbols) and PTFE (closed symbols) are used.

lower temperatures than Li-soaps. This effect becomes more pronounced, the lower the viscosity. For PAO (18/40) no drop in efficiency above 4  $\Delta M$  is observed anymore; we thus conclude the PTFE to fill in for the collapsed baseoil film at high loads. As a result, temperature is significantly reduced, making the PTFE-enhanced PAO (18/40) useful also for higher loads, and therefore being a multi-purpose grease. This finding is underlined when directly comparing the different viscosity grades within one thickener class as it is done in Figure 8. Within Fig. 8(b) the advantages of the low viscous PAO with PTFE thickener are obvious.

In Figure 9 we finally compare the efficiency data for both thickeners for various baseoil types. The biggest influence of the thickener occurs for PAO, which we already discussed. For the other oil types effects are diminished or negligible, respectively. The PTFE-thickened low viscous PAO shows

very high efficiency for all load steps, outrunning the up to now superior ester-based grease. This fact is an example for the interdependence of different grease constituents and demonstrates well the complexity of grease development.

### Conclusion and Outlook

In this contribution the effect of various grease constituents on efficiency and temperature in small plastic gears comprised of a steel worm and PA66 gear wheel is elucidated. Conducting load step tests, the efficiency and temperature close to the tribo-contact are evaluated for a broad variety of model greases. Investigating different NLGI classes, it turns out that for greases with low viscous baseoils, efficiency increases with NLGI class. For high viscous baseoils the opposite behavior is found; moreover, the dependence on consistency seems to be less pronounced. The effect of baseoil

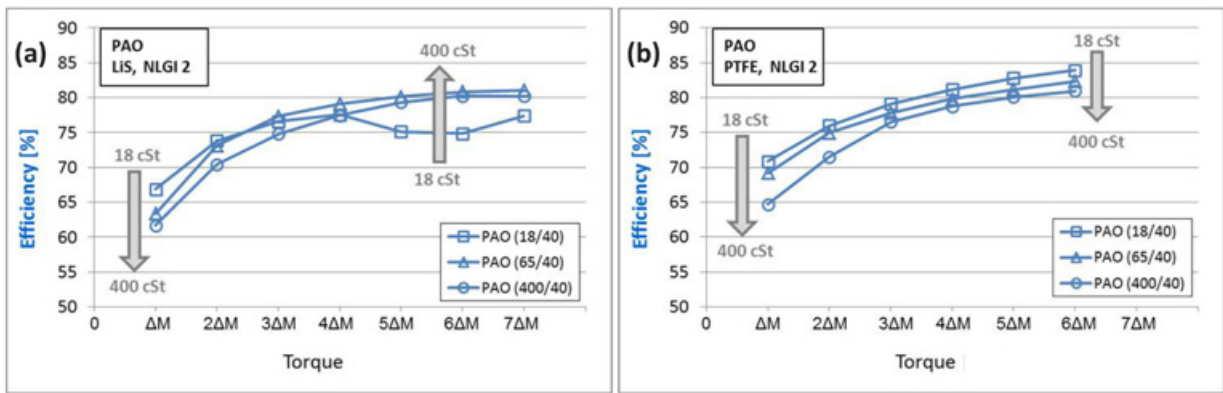

Figure 8 Efficiency as a function of Torque for (a) Li-soaps and (b) PTFE pastes. All greases exhibit NLGI 2 and are comprised of PAO baseoils with viscosity 18- 400cSt.

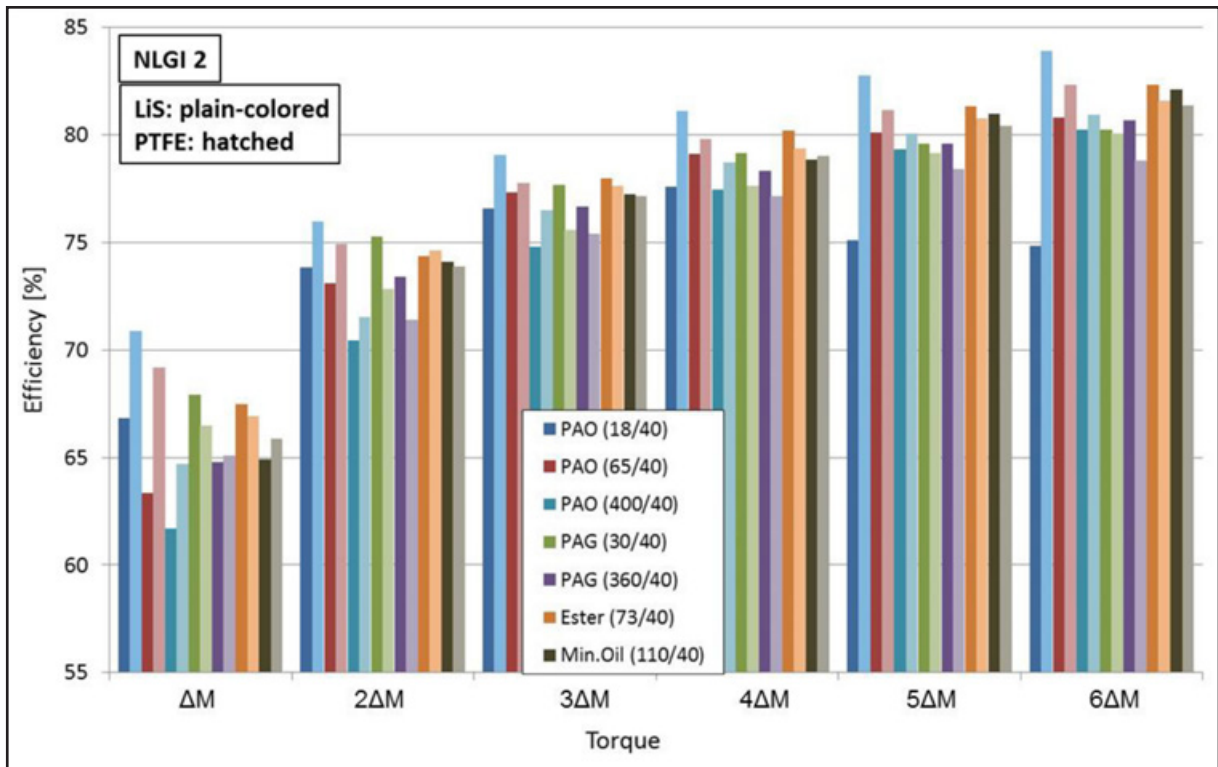

Figure 9 Efficiency as a function of Torque for greases with chemically different baseoils. All greases exhibit NLGI 2. Thickener is Li-soap (plain-colored) and PTFE (hatched).



**Table 1** List of greases used in this contribution; oil viscosity refers to T=40°C.

| Serial Number | Baseoil     |                 | Thickener |      |
|---------------|-------------|-----------------|-----------|------|
|               | Type        | Viscosity [cSt] | Type      | NLGI |
| 1             | PAO         | 18              | Li-soap   | 00   |
| 2             | PAO         | 18              | Li-soap   | 0    |
| 3             | PAO         | 18              | Li-soap   | 1    |
| 4             | PAO         | 18              | Li-soap   | 2    |
| 5             | PAO         | 18              | Li-soap   | 3    |
| 6             | PAO         | 65              | Li-soap   | 2    |
| 7             | PAO         | 400             | Li-soap   | 0    |
| 8             | PAO         | 400             | Li-soap   | 2    |
| 9             | PAO         | 400             | Li-soap   | 3    |
| 10            | Mineral Oil | 110             | Li-soap   | 2    |
| 11            | PAG         | 30              | Li-soap   | 2    |
| 12            | PAG         | 360             | Li-soap   | 2    |
| 13            | Ester       | 73              | Li-soap   | 2    |
| 14            | PAO         | 18              | PTFE      | 2    |
| 15            | PAO         | 65              | PTFE      | 2    |
| 16            | PAO         | 400             | PTFE      | 2    |
| 17            | Mineral Oil | 110             | PTFE      | 2    |
| 18            | PAG         | 30              | PTFE      | 2    |
| 19            | PAG         | 360             | PTFE      | 2    |
| 20            | Ester       | 73              | PTFE      | 2    |

viscosity depends on the load. For low loads one finds low viscous baseoil greases to exhibit higher efficiency than greases with high viscous oils, which is attributed to internal friction caused by shearing the lubricating film. In case of high loads, ranking is reversed, meaning the low viscous baseoil leads to low efficiency. This is explained through a collapse of the lubricating film. Variation of baseoil chemistry reveals that for low loads polyalkylene glycols lead to higher efficiency values than polyalpha olefins, while they are almost similar for high loads. The ester oil stands out by showing high efficiency over the whole load range. Finally, the type of thickener is inspected. For PAO-based greases PTFE shows a significant increase in efficiency compared to Li-soap. This effect is more pronounced the lower the baseoil viscosity, hence we assume the PTFE to fill in for the collapsed oil film — especially at high loads. This makes the PTFE-thickened, low-viscous PAO to the superior lubricant under the greases investigated. For the other oil types effects of PTFE are diminished.

Future work will focus on the effect of additives. In addition the scope of operating conditions will be extended to different rotation speeds and temperatures. Finally the distribution of grease within the gear — especially the adhesion to the worm and gear wheel — will be inspected. **PTE**

**For more information.** Questions or comments regarding this paper? Contact A. Bormuth at: [Andre.Bormuth@klueber.com](mailto:Andre.Bormuth@klueber.com).

## References

1. Robert, J. Lubrication of thermoplastic materials," Journal of Synthetic Lubrication 23 (4), 2006, pp. 153-166.
2. Sinha, S. K. Polymer Tribology, Imperial College Press 2009.
3. Ehrenstein, G. W. Maschinenelemente aus Kunststoffen, 'Konstruktion' series. Dusseldorf: Springer VDI Verlag 2005.
4. Barton, P. Tragfähigkeit von Schraubrad- und Schneckengetrieben der Werkstoffpaarung Stahi/Kunststoff. Ruhr-Universität Bochum Diss. 2000.
5. Wassermann, J. "Einflussgrollen auf die Tragfähigkeit von Schraubradgetrieben der Werkstoffpaarung Stahi/Kunststoff," Ruhr-Universität Bochum Diss. 2005.
6. ASTM 217. Standard Test Methods for Cone Penetration of Lubricating Grease.
7. Bartenev, G. M. *Friction and Wear of Polymers*, Khimiya Press, Moskau 1972.

8. Mezger, T. G. Das Rheologie Handbuch, Vincentz Network 2012.
9. Stribeck, R. "Die wesentlichen Eigenschaften der Gleit- und Rollenlager," Z. VDI Vol. 46, 1902, pp. 1341-1348

**André Bormuth** studied physics and chemistry at the TU Darmstadt, Fraunhofer LBF and Center for Smart Interfaces (CSI), focussing on polymers and molecular dynamics simulations. After finishing in 2012 his Dr.rer.nat. degree in physics, he went the following year (2013) to the CSI and finished his B.Sc. in chemistry. That same year he started as Project Leader Polymertribology at Freudenberg Corporate Innovation and switched to Klüber Lubrication München in 2015. Bormuth is currently focused on Group Tribology Fundamentals and Component Analysis for Klüber.



**Jan Zuleeg** graduated in mechanical engineering focused on production engineering at the University of Erlangen-Nürnberg in 1998. After that he started at Klüber Lubrication München as a tribologist and is now responsible for the development of tribological test methods especially for automotive applications.



**Reiner Schmitz** studied physics with a focus on surface analytics. After graduation he joined Kodak before moving on to Molykote, where he worked in tribology and subsequently joined Klüber Lubrication. During his more than 20 years at Klüber he worked as product developer for greases. Schmitz focused increasingly on automotive applications — plastic actuators, for example — before his retirement earlier this year.



**Christof Schmitz** studied chemistry at the RWTH Aachen before completing his doctorate in polymer chemistry at the Leibniz Institute for Interactive Materials. He joined Freudenberg Corporate Innovation in 2008 as project manager and moved to Klüber Lubrication München in 2013. Since 2014 he has worked as a group leader in product development for the automotive industry.



**Helmut Meven** trained as a skilled chemical worker and completed further training as a technician. Since 1998 he has been working in lubricant development at Klüber Lubrication in various fields (automotive, oils and gears). Since 2013 Meven has been active in training with supporting activities in the laboratory.



**Matthias Pfadt, M. Sc.**, has since 1915 been a manager for Application Engineering at Klüber Lubrication München. He received his master's degree in mechanical engineering from TU München in 2015. He has given presentations at the VDI conference for plastic gears, ATV-SEMAPP for plastic tribology and a keynote speech at the 21st International Colloquium Tribology. Since 2017 Pfadt has been investigating the potential of water containing hydro lubricants for gear applications.



For Related Articles Search

lubrication

at [www.powertransmission.com](http://www.powertransmission.com)

## For more information.

Have questions or comments regarding this technical paper? Contact Andre Bormuth at [andre.bormuth@klueber.com](mailto:andre.bormuth@klueber.com).

# CFD Simulation of Geared Transmissions with Injection Lubrication

H. Liu, F. Link, T. Lohner, K. Stahl

## Introduction

Sufficient lubricant supply to all machine elements in geared transmissions is required for reliable operation. Depending on the speed, usually a small amount of lubricant is sufficient for lubricant film formation, whereas most of the lubricant is needed for cooling. As lubricant is kept in motion, lubrication always involves hydraulic losses. For oil lubrication at high speeds, the hydraulic losses can share a remarkable amount of the overall power losses of geared transmissions. Injection lubrication is a common way of lubrication particularly in high-speed transmissions, which currently attracts high attention in terms of e-mobility applications. Injection lubrication usually involves far less hydraulic power losses compared to dip lubrication and allows direct oil supply to individual machine elements as well as effective cooling and filtration by external oil supply units.

In general, no-load gear losses and oil distribution can be observed by experimental setups. Through the years, several experimental studies on injection-lubricated gears were conducted (Refs. 20–22). The observed relations on the no-load loss with regard to the gear geometry, injection volume and injection speed were partially converted into empirical equations.

According to Mauz (Ref. 21), the no-load power loss of injection-lubricated gears can be categorized as impulse, squeezing and windage power loss:

$$P_{LG0} = P_{LG0,I} + P_{LG0,S} + P_{LG0,W} \quad (1)$$

The impulse power loss  $P_{LG0,I}$  occurs when injected oil impinges on the tooth flanks of the gears. Based on Aiura et al. (Ref. 4), Mauz (Ref. 21) derived a simplified approach for the impulse loss torque  $T_{LG0,I}$  for gear pairs with a circumferential speed of  $v_t < 60$  m/s:

$$T_{LG0,I} = C_1 \cdot r_w \cdot \rho \cdot \dot{V}_{in} \cdot (v_t \pm v_{in}) \quad (2)$$

|                |                           |                   |
|----------------|---------------------------|-------------------|
| $C_1$          | variant coefficient       | -                 |
| $\rho$         | density                   | kg/m <sup>3</sup> |
| $v_t$          | circumferential speed     | m/s               |
| $r_w$          | pitch radius              | mm                |
| $\dot{V}_{in}$ | oil injection volume rate | l/min             |
| $v_{in}$       | injection speed           | m/s               |

Note that the impulse power loss can take negative values in case of a larger injection speed than circumferential speed.

The squeezing power loss  $P_{LG0,S}$  occurs when oil is squeezed out of the gear meshing zone in both axial and radial direction. Mauz (Ref. 21) derived an equation for the squeezing loss torque  $T_{LG0,S}$  for gear pairs with a circumferential speed of  $v_t < 60$  m/s:

$$T_{LG0,S} = C_1 \cdot 4.12 \cdot \rho \cdot r_w \cdot \dot{V}_{in}^{0.75} v_t^{1.25} b^{0.25} \cdot m_n^{0.25} \left(\frac{v}{v_0}\right)^{0.25} \cdot \left(\frac{h_z}{h_{z0}}\right)^{0.5} \quad (3)$$

|                |                           |                    |
|----------------|---------------------------|--------------------|
| $C_1$          | variant coefficient       | -                  |
| $r_w$          | pitch radius              | mm                 |
| $v_t$          | circumferential speed     | m/s                |
| $b$            | tooth width               | mm                 |
| $\nu$          | kinematic viscosity       | mm <sup>2</sup> /s |
| $h_z$          | tooth height              | mm                 |
| $\rho$         | density                   | kg/m <sup>3</sup>  |
| $\dot{V}_{in}$ | oil injection volume rate | l/min              |
| $v_{in}$       | injection speed           | m/s                |
| $m_n$          | normal module             | mm                 |
| $\nu_0$        | reference viscosity       | mm <sup>2</sup> /s |
| $h_{z0}$       | reference tooth height    | mm                 |

Note that the squeezing power loss is neglected if the injection speed is opposite the direction of the circumferential speed (Ref. 21).

The windage power loss  $P_{LG0,W}$  is caused by a secondary medium — mostly air. For low circumferential speeds, the windage power loss shares a marginal percentage in comparison to the impulse and squeezing power loss.

The empirical equations of Mauz (Ref. 21) are easily applicable, which made them part of modern gear calculation programs for geared transmissions (e.g., Ref. 11). However, its range of application and transferability to industrial operating conditions is usually limited and many mechanisms are simplified.

## Literature Review

The application of CFD (computational fluid dynamics) methods to geared transmissions provides more detailed insights into the oil flow and no-load losses (Ref. 8). CFD methods are flexible and easily applicable, have no limitations with regard to gear geometry and housing shape and can describe physical phenomena very accurately (Refs. 18–19).

Many CFD studies of geared transmissions have focused on dip lubrication. Thereby, besides finite volume (FV)-based methods, smoothed particle hydrodynamics (SPH) methods are also used. An overview of literature was given by the authors in (Refs. 17–19). Selected studies are summarized in the following.

Concli et al. (Refs. 5–7, 13) carried out many numerical studies on the oil flow and churning loss of dip-lubricated spur and planetary gears by using the FV-based CFD method. The results with respect to the gear churning loss are in good agreement with the experimental measurements. In addition to that, a specific mesh-handling technique was introduced, which is specially designed for gear meshing problems

allowing a reduction of the computing time by over 90% (Ref. 7).

Liu et al. (Refs. 18–19) applied a three-dimensional FV-based CFD model to investigate the oil flow and the churning power loss of a dip-lubricated single-stage spur gearbox. The results for both oil distribution and churning loss torque agree very well with both high-speed camera recordings and loss torque measurements. The studies show that the FV method is very suitable for predicting the oil flow and the no-load loss in geared transmissions.

Besides FV-based CFD methods, particle-based CFD methods, i.e.—smoothed particle hydrodynamics (SPH)—have been applied to geared transmissions. SPH is a Lagrangian and mesh-free method in which the medium is represented by discrete fluid elements, the motion in space and time of which is calculated through a set of equations developed by Monaghan (Ref. 23). In comparison to conventional CFD methods, SPH can easily handle free surface flows without much modeling effort due to its mesh-free nature.

Emmer (Ref. 9) was one of the first people to explore the potential of SPH for the simulation of oil flow in gearboxes. He investigated the oil flow as well as the churning losses of a dip-lubricated single gear and gear pair. The findings show that the application of SPH to gearboxes requires fundamental optimization to obtain physically plausible results on the oil flow and churning losses.

Liu et al. (Ref. 17) set up a SPH-based simulation model to investigate the oil flow and the churning loss of a dip-lubricated spur gear pair in a test gearbox. The model was studied by varying the gear speed, lubricant viscosity and oil sump temperature. The authors point out that, besides the great potential of SPH further optimizations on current SPH, codes are required for good predictions of oil flow and no-load gear loss in geared transmissions.

As indicated above, many CFD studies on dip-lubricated geared transmissions have been performed. However, there are very few numerical studies on injection lubrication.

Arisawa et al. (Refs. 1–3) investigated the impulse and windage loss of an injection-lubricated bevel gear pair for an aircraft by CFD simulation and loss measurements. They set up a three-dimensional, two-phase FV-based CFD model with a so-called porous body approach to illustrate the gear meshing. The focus of the study was the influence of the shroud of bevel gears on the no-load gear loss. The results show that the CFD simulations are quantitatively in good agreement with the measurements. It was found that the gear impulse loss takes the greatest part of the no-load gear losses, whereas the windage loss only shares a very small percentage. It was revealed that, by introducing shrouds, the no-load gear loss could be reduced by up to 36% compared to unshrouded gears. The authors also point out that by observing the oil flow by CFD, it was possible to design spur gear trains of the gearbox in a manner that prevents stagnation of oil inside the gearbox when the aircraft changes attitude.

Fondelli et al. (Ref. 10) studied the impulse loss of a single high-speed spur gear pair with injection lubrication numerically. They applied an FV-based CFD model with a local mesh refinement feature. This meshing technique allowed acceptable computing time. The simulation model captured the oil set into motion as well as the droplet and ligament formation by the breakup of the jet. It was shown that the pressure distribution on the teeth flank resulting from the oil jet impact contributes significantly to the resistance torque. The influence of the shear forces was

evaluated as negligible.

The brief literature review shows that many CFD studies have analyzed the oil flow and no-load loss of dip-lubricated geared transmissions. Only very few numerical studies have focused on injection lubrication. Within the framework of this paper, an FV-based CFD model of a single-stage injection-lubricated test gearbox of the FZG gear test rig was built to investigate the influence of the injection volume, oil viscosity and gear speed on the oil supply and distribution. The results also include a comparison of the simulated no-load gear losses with empirical calculations.

## Object of Investigation and Operating Conditions

The object of investigation is the FZG no-load power loss test rig. It features the same test gearbox geometry as the test rigs used by the authors in (Refs. 17–19). The FZG no-load power loss test rig was specifically designed for experimental investigations on the oil flow and no-load loss of gears.

**FZG no-load power loss test rig.** The mechanical layout of the FZG no-load power loss test rig is shown (Fig. 1, left). It consists of four main parts: the electric engine, the intermediate gearbox, the loss torque meter and the test gearbox. The test gearbox is planned to be adapted for injection lubrication similar to the manner shown (Fig. 1, right).

The test rig has already been described (Ref. 18). The main parts are repeated below. The speed of the electric engine is transmitted through the intermediate gearbox and the pinion shaft to the test gearbox. The no-load loss caused

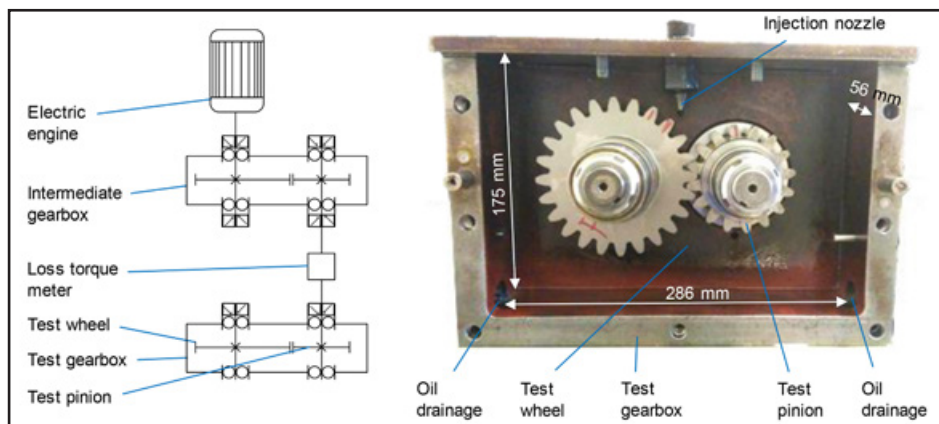

Figure 1 Mechanical layout of the FZG no-load power loss gear test rig (left); injection-lubricated test gearbox (right).

by the test gearbox is measured by the loss torque meter on the pinion shaft and includes the gear losses as well as the losses of the four bearings and two seals. In order to minimize the losses from bearings and to obtain a clear view of the oil flow from the front, small needle bearings are installed. The front cover was made of transparent acrylic glass in order to obtain a clear view of the oil flow. The considered torque meter has a measuring range of 10 Nm and a measuring error of ±0.1%.

The injection lubrication of the test gearbox is planned to be adopted from other FZG gear test rigs (Figure 1, right). The injection nozzle is placed just above the gear meshing zone. The injection nozzle has an oval shape (12 mm long, 1.5 mm wide) so that the oil can be injected over the width of the gears. A PLC control cabinet controls the oil temperature in the oil supply unit as well as the oil injection volume. The injected oil can flow back to the oil supply unit through the two oil drainage holes (Ø24 mm) at the bottom of the two side walls of the test gearbox.

**Test gears.** As used previously (Refs. 17–19), the well-known test gears

of FZG type C-PT are considered. The geometric data for both the pinion and the wheel are listed in Table 1.

**Lubricants.** The mineral oils FVA3 and FVA2 (Ref. 16) with viscosity grades of ISO VG 100 and ISO VG32 are considered. Table 2 gives an overview of the main properties of these lubricants.

**Operating conditions.** The operating conditions were selected based on the empirical equations for the no-load loss introduced in section 1. A set of 12 parameters was chosen. The considered influencing parameters include three circumferential speeds, two oil injection volume rates and two oil injection velocities. The oil temperature is set to 40°C. Table 3 gives an overview on the operating conditions.

### Numerical Model

The numerical model is implemented and solved in the commercial CFD software *Ansys Fluent* 18.0.

### Governing Equations.

The behavior of fluids can be described with conservation equations (Ref. 12). Based on the Euler equations of motion, the momentum conservation equa-

tions can be extended with mass and energy conservation equations to form a system of partial differential equations of the second order. An overview on the Navier-Stokes equations and turbulence modelling can be found in the previous work of the authors (Ref. 18).

In this study, due to no-load operating conditions, thermal influences are neglected and therefore the energy conservation equation is not considered; a k-ε turbulence model consisting of two coupled transport equations is used. The fluid is considered as Newtonian fluid.

**Finite volume method.** In order to find an analytical solution for the governing equations, a decoupling of the conservation equations would be necessary. Reynolds or Prandtl numbers were introduced for solving simple problems. For complex applications, no analytical solution can be found and numerical solutions are required. One of the most common methods for practical applications for fluid mechanics is the finite volume (FV) method (Ref. 14). Thereby, the calculation domain is discretized with finite volumes. The accuracy of numerical solutions generally increases with the fineness of the grid and discretization order. In each finite volume, the Lipschitz constancy must be fulfilled.

By integrating the conservation equations on the finite volumes, the divergence term is transformed into a surface integral:

$$\frac{\partial}{\partial t} u(x, t) + \nabla \cdot f(u(x, t)) = 0 \quad (4)$$

$$\int_{\partial \Omega_i} \frac{\partial}{\partial t} u(x, t) d\Omega + \int_{\partial \Omega_i} f(u) \cdot n dS = 0 \quad (5)$$

These surface integrals can easily be determined by Gauss quadrature, so that partial differential equations (in time and space) are converted into a set of linear equations, which can be solved efficiently. The FV method is widely used because of its conservation character.

**Volume of fluid method.** For oil flow simulations with two media, a two-phase model is necessary. The most common model for immiscible fluids is the Volume of Fluid (VoF) method. It is based on a scalar fraction function *C*, which is defined as the integral of

Table 1 Geometry of CPT-type gears

|            | a in mm | z <sub>1/2</sub> | m <sub>n</sub> in mm | α in ° | x <sub>1/2</sub> in mm | b <sub>1/2</sub> in mm | da <sub>1/2</sub> in mm |
|------------|---------|------------------|----------------------|--------|------------------------|------------------------|-------------------------|
| Pinion (1) | 91.5    | 16               | 4.5                  | 20.0   | 0.182                  | 14                     | 82.5                    |
| Wheel (2)  |         | 24               |                      |        | 0.171                  |                        | 118.4                   |

Table 2 Properties of the considered mineral oils

| Oil  | Kinematic viscosity at 40°C, ν(40°C) in mm <sup>2</sup> /s | Kinematic viscosity at 100°C, ν(100°C) in mm <sup>2</sup> /s | Density at 15°C, ρ (15°C) in kg/m <sup>3</sup> |
|------|--|--|--|
| FVA3 | 95.0   | 10.7   | 864  |
| FVA2 | 32.0   | 5.4  | 855  |

Table 3 Considered operating conditions

| Parameter number | Rotational speed of pinion n <sub>i</sub> in rpm | Circumferential speed at the pitch circle v <sub>t</sub> in m/s | Oil injection volume rate V <sub>oil</sub> in l/min | Oil injection speed v <sub>oil</sub> in m/s | Oil  |
|------------------|--|---|---|---|------|
| 1                | 130  | 0.5   | 2   | 2.1   | FVA3 |
| 2                |  |   |   |   | FVA2 |
| 3                |  |   | 4   | 4.2   | FVA3 |
| 4                |  |   |   |   | FVA2 |
| 5                | 522  | 2.0   | 2   | 2.1   | FVA3 |
| 6                |  |   |   |   | FVA2 |
| 7                |  |   | 4   | 4.2   | FVA3 |
| 8                |  |   |   |   | FVA2 |
| 9                | 2166   | 8.3   | 2   | 2.1   | FVA3 |
| 10               |  |   |   |   | FVA2 |
| 11               |  |   | 4   | 4.2   | FVA3 |
| 12               |  |   |   |   | FVA2 |

a fluid's characteristic function in the finite volume (Ref. 15). If a finite volume is "empty" (e.g. 0% oil), the value of  $C$  is zero; when the finite volume is "full" (e.g. 100% oil),  $C$  equals 1; and when there is a fluid interface in the cell,  $C$  is between 0 and 1. The normal direction of the fluid interface is at the position where the value of  $C$  changes most rapidly. Each finite volume includes the volume fraction of every fluid (e.g. oil and air), while the fluids share a single set of momentum equations. It means that fluid variables are calculated by the average of the volume fraction of the fluids in the finite volume, whereas the averaged properties are then used to solve a single set of conservation equations in each volume. The resolution of the regarded fluids depends on the size of the finite volumes.

**Geometry and mesh.** The conservation equations are solved iteratively on finite volumes during calculation. The mesh of the injection-lubricated test gearbox (Fig. 2, right) essentially consists of five domains: the pinion domain; the wheel domain; the outer domain; the oil injection domain; and the remeshing domain. The entire model represents a negative model of the test gearbox. Due to the symmetry of the test gearbox, the simulation model was reduced to one-half by setting the middle plane of the test gearbox to a "symmetry" boundary condition. As the general test gearbox configuration has also been considered by the authors in (Refs. 18–19), some parts are repeated to improve readability.

The mesh of each single domain is connected with the other domains as shown (Fig. 2). The mesh of the pinion and wheel domain is discretized with inflation layers and does not undergo any mesh deformation. During the simulation, the meshes of the pinion and wheel domain rotate inside the gearbox domain at predefined rotational speeds. The outer domain mainly consists of tetrahedral elements and does not undergo any mesh deformation. The elements at the boundary walls of the gearbox are defined as "walls." An oval-shaped oil injection domain is modeled at the position between the injection nozzle and the gear meshing zone. The oil injection volume rate is

defined as an "inlet" by a predefined oil inlet speed at the top of the oval shaped oil injection domain. The oil drainages at the bottom of two sidewalls are defined by two round planes, which are set as the "outflow." The domain of the remeshing zone fills the cavity between the outer domain and the pinion and wheel domain. During operation, the meshing zone of the pinion and wheel is a transient area that changes for every gear meshing position. Thus, the remeshing zone consists of a deformable meshing structure that changes with every time step of the rotating pinion and wheel domain.

The domain of the remeshing zone is discretized with deformable prism elements that deform and stretch with every time step of the rotating pinion and wheel domain. When the mesh quality, e.g. —skewness and orthogonal quality, falls below a predefined minimum mesh quality, the affected elements are reconstructed. This remeshing process is numerically expensive; thus, only the area affected by the rotating and meshing gears is assigned as the remeshing domain. During a numerical analysis, bad element quality and numerical singularities in the very small gap between the tooth flanks, i.e. gear backlash have to be avoided.

Therefore, the very small gap between the tooth flanks is enlarged by scaling the pinion and the wheel to 98% of their actual size. This is currently required for all FV-based CFD simulations of meshing gears. The scaling is not expected to significantly influence the oil distribution and the impulse loss.

For the simulation series, 40 cores of a high-performance computing cluster were used as hardware. A grid with about 0.68 M elements was applied to the mesh model, which results in an average element size between 1.0–1.5 mm<sup>3</sup>. The time step size was set to 0.1° rotation of pinion. A local convergence criterion of 10<sup>-5</sup> was used for all equations. These settings result in a calculation time of about 8–12 h for a single rotation of the pinion.

A grid sensibility analysis has been performed with different element types. The object of investigation was the no-load loss torque of both gears. In a first step, the half model was discretized with tetrahedral elements. Thereby, the element number was varied from 0.62 M to 1.79 M. In a second step, the half model was mainly discretized with prism elements, which were extruded from a planar area. Thereby, the element number was increased from 0.28 M to 0.71 M. In both cases, the maximum change of the

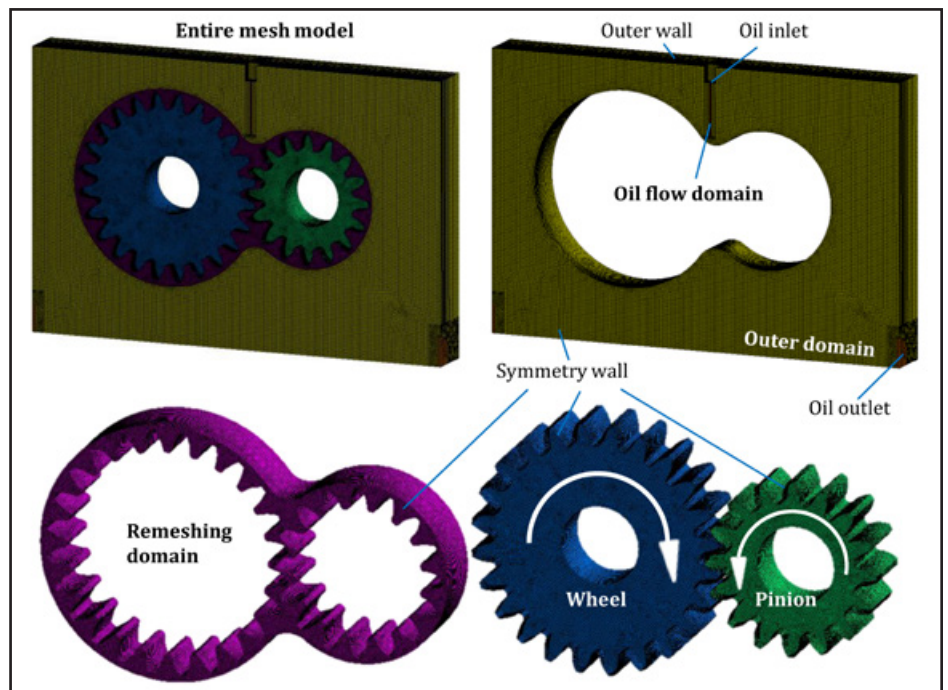

Figure 2 Mesh model of the injection-lubricated test gearbox; entire mesh model (top left); outer domain and oil injection domain (top right); remeshing domain (bottom left); pinion and wheel domain (bottom right).

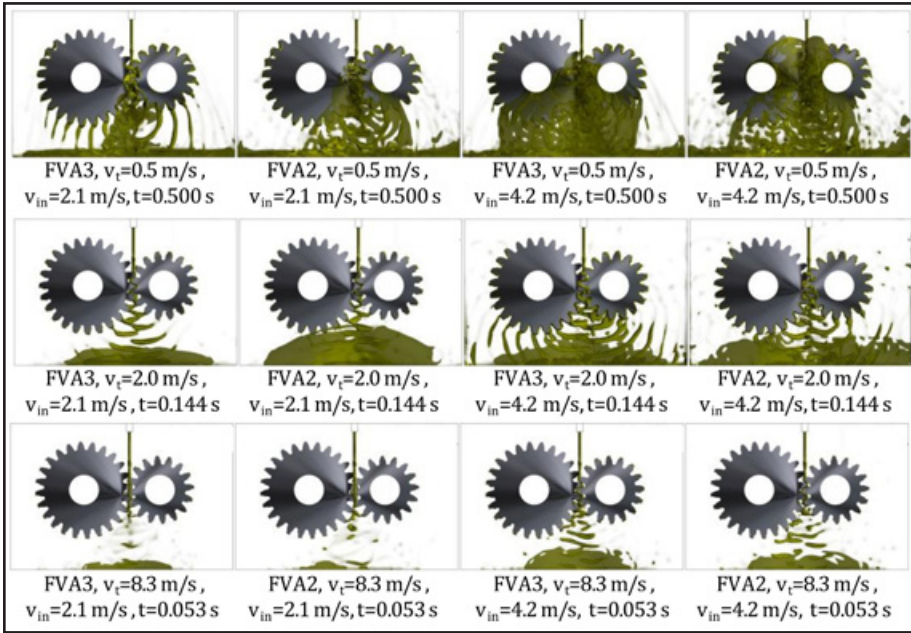

Figure 3 Simulated oil distributions after one rotation of the pinion (front view).

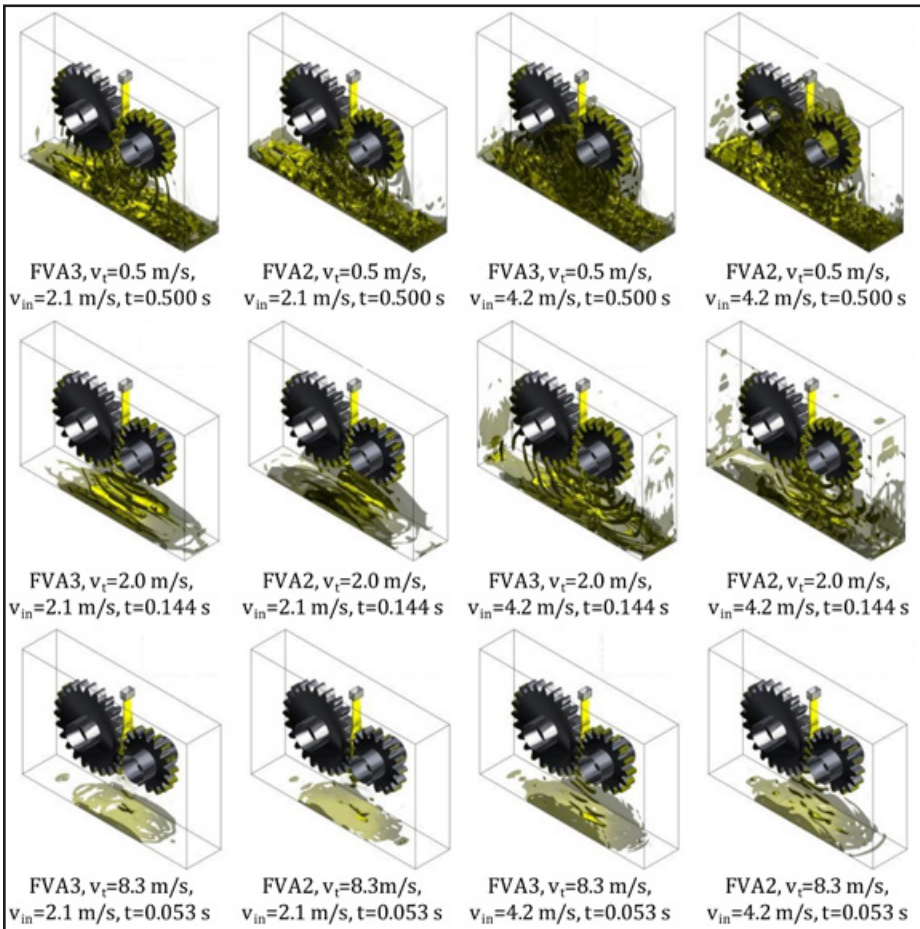

Figure 4 Simulated oil distributions after one rotation of the pinion (isometric view).

no-load loss torque was less than 5%. The oil distribution could be dissolved best with the highest element number. For a similar element number, the computing time of the tetrahedral model was about three times longer than for the prism model. That is mainly due to the higher effort for the remeshing of tetrahedral elements. The tetrahedral model requires stretching and reconstruction of all effected elements in the remeshing zone, whereas for the prism model only the symmetry wall of the remeshing model is stretched and rebuilt. For reasons of computing time, the prism model with 0.68M elements is used.

The no-load loss torque of the gears is derived by the sum of the product of fluid pressure integrated over each finite volume on the circumferential gear surfaces multiplied with the corresponding distance to the axis center. This results in the overall gear no-load loss torque consisting of the impulse, squeezing and windage loss portion.

### Results

Results on the oil distribution and the no-load power loss of the injection-lubricated test gearbox are presented based on the operating conditions shown in Table 3.

**Oil distribution.** Figures 3 and 4 show the simulated oil distributions in front and isometric views, respectively. Thereby, the current oil volume fraction obtained from the CFD simulation is illustrated. All results correspond to a time, when one pinion rotation after the first oil contact has finished. This already results in an almost quasi-stationary oil distribution and loss torque.

The left and right two columns of Figure 3 and Figure 4 correspond to the oil injection speeds  $v_{in}$  of 2.1 m/s and 4.2 m/s, respectively, whereas the three rows relate to the circumferential speeds  $v_t$  of 0.5 m/s, 2.0 m/s and 8.3 m/s. The influence of the oil injection speed  $v_{in}$  and the circumferential speed  $v_t$  is superordinate compared to the influence of the oil viscosity (FVA3 and FVA2), which can be observed by comparing the first and second and the third and fourth columns, respectively.

The current oil volume inside the gearbox decreases with increasing

circumferential speed  $v_t$ . This is due to the fact that less oil has entered the gearbox after one rotation of the pinion in total. The amount of oil leaving the meshing zone after each gear engagement decreases with increasing  $v_t$  due to the shorter cycle time. This and the increase in the centrifugal force with increasing  $v_t$  result in more dispersed oil flows with increasing  $v_t$ . For  $v_t=8.3$  m/s and  $v_{in}=2.1$  m/s, the dispersed oil droplets cannot even be resolved properly by the considered mesh size of the CFD model.

When the oil injection speed  $v_{in}$  is higher than the circumferential speed  $v_t$ , there is a considerable amount of oil dragged in the axial direction and the oil tracks in radial direction after leaving the meshing zone are recognizable. The higher  $v_{in}$  compared to  $v_t$ , the clearer this observation becomes. For  $v_t=0.5$  m/s and  $v_{in}=4.2$  m/s, even a damming effect can be observed above the gear meshing zone. The ratio of  $v_t$  and  $v_{in}$  has a strong effect on the axial and radial squeezing of oil.

In comparison to the circumferential and injection speed, the influence of the oil viscosity (FVA3, FVA2) on the oil distribution is subordinate. For the higher viscous FVA3, pronounced oil tracks gradually swinging off the teeth tend to occur. This is due to the higher resistance to shear stress, which also explains that the oil tracks stick to the gear teeth (cf.  $v_t=0.5$  m/s and  $v_{in}=2.1$  m/s for FVA2 and FVA3). For the less viscous FVA2, the oil rather appears as small and dispersed oil droplets.

**No-load power loss.** This section shows the simulation results on the no-load power losses with respect to the results on the oil distribution in the previous section. Each simulated value is averaged over 270° pinion rotation, i.e.—12 gear engagements, and represents the overall gear no-load power loss including the impulse, squeezing and windage portion. The dissolved no-load power loss (not shown) shows maxima when tooth flanks are orientated perpendicular to the injection direction.

Figure 5 shows the CFD simulation results, which are classified into the empirical results according to Mauz (Ref. 21) (cf. Eqs. 2 and 3). The results

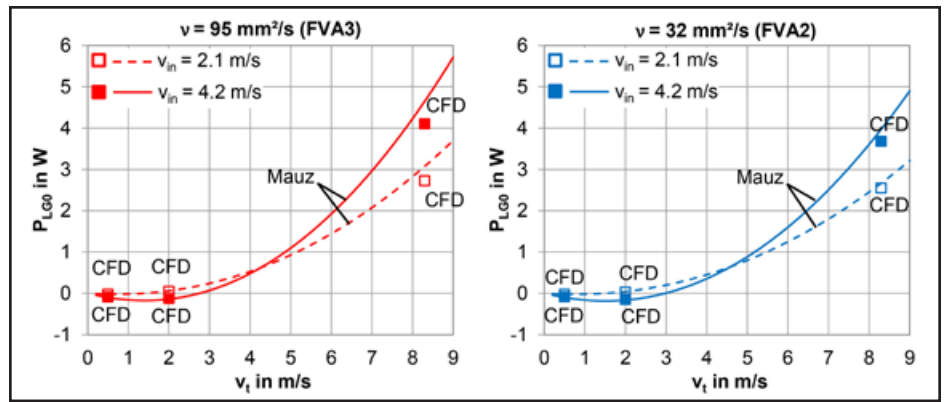

Figure 5 Comparison of no-load power loss between CFD simulation and empirical equations of Mauz (Ref. 21).

are in very good accordance. Note that windage power loss is not explicitly considered in the empirical equations; its portion is considered to be very small for the considered circumferential speeds.

As seen for the oil distribution, the influence of the circumferential speed  $v_t$  and the oil injection speed  $v_{in}$  is superordinate compared to the influence of the oil viscosity (FVA3 and FVA2). In the following, the results are discussed in groups of the circumferential speeds  $v_t=\{0.5, 2.0, 8.3\}$  m/s.

For  $v_t=0.5$  m/s, the oil injection speed  $v_{in}$  is greater than the circumferential speed  $v_t$ . Hence, the oil jet exerts an acceleration torque on the gears, which increases when  $v_{in}$  becomes increasingly larger than  $v_t$ . This results in a negative no-load power loss, which is however very small.

For  $v_t=2.0$  m/s, when the oil injection speed  $v_{in}$  almost equals the circumferential speed  $v_t$ , the no-load power loss is also very small. When  $v_{in}$  is increased to 4.2 m/s, the oil jet again exerts an acceleration torque resulting in a negative no-load power loss.

For  $v_t=8.3$  m/s, which clearly exceeds the oil injection speed  $v_{in}$ , the injected oil is accelerated to the speed of the tooth flanks, which results in a larger no-load power loss. It rises with  $v_{in}$  due to the increasing amount of oil to be accelerated.

In comparison to the circumferential speed  $v_t$  and oil injection speed  $v_{in}$ , the influence of the oil viscosity is subordinate. This finding is consistent with the empirical equations of Mauz (Ref. 21), as the influence of oil viscosity on the squeezing power loss is relatively small

(Eq. 3) and the impulse power loss is independent of the oil viscosity (Eq. 2).

It should be noted that the no-load power loss caused by injection lubrication is only a small fraction of that created by dip lubrication (Ref. 19).

## Conclusion

In this study, a finite volume CFD simulation model of a single-stage injection-lubricated test gearbox was applied to investigate its oil flow and no-load power loss. The results provide physically plausible information on the oil supply and its distribution. The simultaneously simulated no-load losses show very good accordance with empirical equations. It is proved that the CFD method has developed into valuable tools for studying injection-lubricated gearboxes. In the next step, the presented test rig will be adapted for injection lubrication so that the simulation results can be validated by measurement of the no-load loss torque and oil distribution. Future work will focus on the impact of various influencing factors like gear geometry, gearbox housing and high-speed regimes. **PTE**

**For more information.** Questions or comments regarding this paper? Contact Hua Liu at [liu@fzg.mw.tum.de](mailto:liu@fzg.mw.tum.de).

## References

1. Arisawa, H. "Computational Fluid Dynamics Simulations and Experiments for Reduction of Oil," Kawasaki Heavy Industries. (2014).
2. Arisawa, H., M. Nishimura, H. Imai and T. Goi. "CFD Simulation for Reduction of Oil Churning Loss and Windage Loss on Aeroengine Transmission Gears," ASME Turbo Expo 2009: Power for Land, Sea, and Air, Florida USA, 1, 63–72. DOI=10.1115/ GT2009-59226. (2009).
3. Arisawa, H., M. Nishimura, H. Imai and T. Goi. "Computational Fluid Dynamics Simulations and Experiments for Reduction

- of Oil Churning Loss and Windage Loss in Aeroengine Transmission Gears," *J. Eng. Gas Turbines Power* 136, 9, 92604. DOI=10.1115/1.4026952, (2014).
4. Ariura, Y., T. Ueno, Sunaga and S. Sunamoto. "The Lubricant Churning loss in Spur Gear Systems," *Bulletin of the JSME*, Band 16, Nr. 95, 881-892. (1975).
  5. Concli, F. "Numerical Modelling of the Churning Power Losses of Gears: an Innovative 3-D Computational Tool Suitable for Planetary Gearbox Simulation." *Tribology International*, 103, 58-68, DOI=10.13140/RG.2.2.10487.52649. (2016).
  6. Concli, F. "Low-Loss Gears Precision Planetary Gearboxes; Reduction of the Load-Dependent Power Losses and Efficiency Estimation Through a Hybrid Analytical-Numerical Optimization Tool," *Forschung im Ingenieurwesen*, 4, 395-407, DOI=10.1007/s10010-017-0242-0. (2017).
  7. Concli, F. and C. Gorla. "Numerical Modeling of the Power Losses in Geared Transmissions: Windage, Churning and Cavitation Simulations with a New Integrated Approach that Drastically Reduces the Computational Effort," *Tribology International*, 103, 58-68, DOI=10.1016/j.triboint.2016.06.046. (2016).
  8. Concli, F. and C. Gorla. "Windage, Churning and Pocketing Power Losses of Gears; Different Modeling Approaches for Different Goals," *Forschung im Ingenieurwesen*, 3-4, 85-99. DOI=10.1007/s10010-016-0206-9. (2016).
  9. Emmer, K. "Simulation of Oil Flow in Gear Boxes via Smoothed Particle Hydrodynamics," Diplomarbeit, Karl-Franzens-Universität Graz. (2015).
  10. Fondelli, T., A. Andreini, R. Da Soghe, B. Facchini and L. Cipolla. "Numerical Simulation of Oil Jet Lubrication for High-Speed Gears," *International Journal of Aerospace Engineering*, Volume 2015. DOI=10.1155/2015/752457. (2015).
  11. Geiger, J., B.-R. Höhn and K. Michaelis. "Validierung WTplus - Validierung des Programmsystems WTplus 2.0," FVA-Forschungsvorhaben Nr. 69 V, Heft 959, Frankfurt. (2010).
  12. Gersten, K. "Einführung in die Strömungsmechanik" Vieweg, Braunschweig, 1992).
  13. Gorla, C., F. Concli, K. Stahl, B.-R. Höhn, K. Michaelis, H. Schultheiß and J.-P. Stempler. "CFD Simulations of Splash Losses of a Gearbox," *Advances in Tribology*, Volume 2012, DOI=10.1155/2012/616923, (2012).
  14. Hirsch, C. *Numerical Computation of Internal and External Flows*, Elsevier Butterworth-Heinemann, Amsterdam, Heidelberg [u.a.]. (2007).
  15. Hirt, C. and B. Nichols. "Volume of Fluid (VOF) Method for the Dynamics of Free Boundaries," *Journal of Computational Physics* 39, 1, 201-225. DOI=10.1016/0021-9991(81)90145-5. (1981).
  16. Laukotka, E. M. *FVA-Heft Nr. 660 Referenzöle - Datensammlung*, Frankfurt/Main. (2003).
  17. Liu, H., G. Arfaoui, M. Stanic, L. Montigny, T. Jurkschat, T. Lohner and K. Stahl. "Numerical Modeling of Oil Distribution and Churning Gear Power Losses of Gearboxes by Smoothed Particle Hydrodynamics," *Journal of Engineering Tribology*, DOI=10.1177/1350650118760626. (2017).
  18. Liu, H., T. Jurkschat, T. Lohner and K. Stahl. "Determination of Oil Distribution and Churning Power Loss of Gearboxes by Finite Volume CFD Method," *Tribology International*, 109, 346-354, DOI=10.1016/j.triboint.2016.12.042. (2017).
  19. Liu, H., T. Jurkschat, T. Lohner and K. Stahl. "Detailed Investigations on the Oil Flow in Dip-Lubricated Gearboxes by Finite Volume CFD Method," *Journal Lubricants*, presented at 6th World Tribology Congress 17.-22, September, Beijing, China, DOI=10.3390/lubricants6020047. (2018).
  20. Massini, D., T. Fondelli, B. Facchini, L. Tarchi and F. Leonardi. "High-Speed Visualizations of Oil Jet Lubrication for Aero-Engine Gearboxes," *Energy Procedia*, 101, 1248-1255. DOI=10.1016/j.egypro.2016.11.140. (2016).
  21. Mauz, W. "Hydraulische Verluste von Stirnradgetrieben bei Umfangsgeschwindigkeiten bis 60 m/s," Dissertation, Universität Stuttgart. (1987).
  22. Mizutani, H., Y. Isikawa and D.P. Townsend. "Effects of Lubrication on the Performance of High-Speed Spur Gears," *Fifth International Power Transmission and Gearing Conference, Chicago, USA*. (1989).
  23. Monaghan, J. J. "Smoothed Particle Hydrodynamics," *Rep. Rog. Phys.*, 68, DOI=10.1088/0034-4885/68/8/R01. (2005).

For Related Articles Search

lubrication

at [www.powertransmission.com](http://www.powertransmission.com)

**Hua Liu** studied Mechanical Engineering and Automotive Technology with a focus on numerical mechanics and drive engineering at the Technical University of Munich (TUM). During his Master's program he did research in the area of finite element analysis of plastic gears. After he had finished his Master's degree in 2014, he has worked as a research associate at FZG focusing on the application of CFD methods in gearboxes.



**Felix Link** studied Mechanical Engineering and Automotive Technology with a focus on computer-aided engineering at the Technical University of Munich (TUM). During his Master's program he did research in the area of the application of CFD methods in gearboxes. After finishing his Master's degree in 2018, he has worked as an engineer for structural mechanics in aircraft engines.



**Thomas Lohner** studied Mechanical Engineering and joined the Gear Research Centre (FZG) at the Technical University of Munich (TUM) as a research associate in 2012. After finishing his Dr.-Ing. degree in 2016, he has worked as post-doctoral fellow and is head of the department EHL-Tribological-Contact and Efficiency at FZG. Lohner's research interests include machine elements, gears and power transmission systems, as well as tribology, elasto-hydrodynamic lubrication, efficiency and heat management.



**Karsten Stahl** studied Mechanical Engineering at the Technical University of Munich. Afterwards, he joined the Gear Research Centre (FZG) at the Technical University of Munich (TUM) as research associate and finished his Dr.-Ing. degree in 2001.



The same year he started as gear development engineer at the BMW group in Dingolfing, subsequently becoming head of the prototyping, gear technology and methods group in 2003. In 2006 he moved to the BMW/MINI plant in Oxford, UK, and the next year (2007) he became department leader for validation driving dynamics and powertrain. In 2009 he returned to Munich as manager for pre-development and innovation management within BMW driving dynamics and powertrain in Munich. Since 2011, Karsten Stahl is a full professor at the Institute for Machine Elements and head of the Gear Research Centre at the Technical University of Munich. The FZG employs about 80 associates — 50 of them PhD candidates and more than 200 students. Organized in 5 departments, Prof. Stahl's research focuses on experimental and theoretical investigations of endurance, tribology, NVH, materials and fatigue analysis. Components in the focus are cylindrical, bevel, hypoid and worm gears, clutches, synchronizers rolling-element bearings, and drive systems."



# Hungry for More?



Everything you need if you buy gears, bearings, motors, couplings and clutches.

## Power Transmission Engineering

- Product and Industry News Updated Daily
- Directory of Mechanical Power Transmission Suppliers
- Exclusive online content in our e-mail newsletters
- Back Issues and Article Archive
- Calendar of Upcoming Events for power transmission professionals

FREE SUBSCRIPTION!

[www.powertransmission.com](http://www.powertransmission.com)

# The Integration Game

NORD DELIVERS IIOT, NEW TECHNOLOGIES AND SYSTEM EFFICIENCY

MATTHEW JASTER, SENIOR EDITOR

If the trend in manufacturing to consolidate equipment and run factories more efficiently continues—and it will—NORD Gear Corporation won't be playing catch up with the rest of the industry. They've made it a priority in recent years to serve customers in areas like material handling, packaging, conveyors, etc., by focusing on system integration and smart manufacturing.



“Improving system and equipment efficiency is a priority. We're trying to get rid of large control cabinets with our decentralized variable frequency drives (VFDs). These control cabinets take up a lot of space and can be quite expensive,” said Dan Breitbarth, engineering manager—control products at NORD. “Another thing we're trying to do is reduce the amount of cabling. If you have all these drives in one cabinet you've got to run individual motor leads out to each gearmotor. With our drive technology, you can set-up a group power feed to reduce the amount of cables necessary to power everything.”

Breitbarth said that NORD is producing gearboxes, motors, VFDs, controls and other drive solutions in 2019 to “help customers reduce spare part inventory, lower production costs and become more energy efficient.”

The company announced expansion plans earlier this year at its corporate headquarters in Waunakee, Wisconsin. NORD's newest expansion will add 86,000 square feet of office and manufacturing space. This will help NORD increase the company's capacity and ensure a continued short lead time delivery. The company currently delivers 24 percent of customer orders same day or next day, and 45 percent within five working days, including custom orders. NORD also added a \$6.2 million building expansion and new paint line in Wisconsin last year.

“Our customers benefit from quicker deliveries, less maintenance procedures and find a way to lower operating costs with NORD equipment,” Breitbarth said.

## Mix-and-Match Components

NORD's success can be partly-attributed to the company's push for more modular and flexible components. “You can seamlessly pair our gearboxes and controls with our IE4 permanent magnet synchronous motors,” Breitbarth said. “Customers are demanding system solutions today, not just mechanical drives. Our products are very modular and interface with all the standardized information systems and networks.”

It's the push toward mechatronic solutions that makes it an exciting time to be involved in the industrial market, according to **Torsten Schultz**, president of NORD Gear Corporation.

“Mechanical engineers are cautious with the electronics. So we've made a huge effort to preprogram system features and capabilities within our components to make it easier for the mechanically-minded person to better understand the electronic side. We can broaden our applications this way and improve our relationships within different market segments,” Schultz said.

An example of this is NORD's ability to reduce the number of different variants in a drive solution. If you look at all the costs—purchasing, commissioning, use and maintenance for an intralogistics and airport application—you want a solution that provides reliability and long service life with lower operating costs. NORD can supply a LogiDrive system (an IE4 synchronous motor, a two-stage bevel gear unit and a NORDAC Link field distributor) which will reduce the amount of equipment needed to run the application and reduce the spare parts necessary to keep it running.

Lowering total cost of ownership and creating an energy efficient system along the way is a strong selling point in *any* industry.

“Energy efficiency is all about system efficiency, not just the motor anymore. We focus on the smallest details so our customers can concentrate on their own applications and not worry what the components are going to do or not do,” Breitbarth said.

## Smart Planning

One of the most prevalent discussions with NORD's customers today is about preventative maintenance and smart manufacturing.

“Each application is different so there's not a one-size-fits-all solution. Utilizing specific features of NORD Control products, such as our internal PLC, enables us to potentially write a program that can perform trend analysis. For example: How many times the motor current goes above a certain threshold,” Breitbarth said. “The range of how simple or



complex this reporting needs to be varies from customer to customer. We have the toolbox to assist in areas like predictive and preventative maintenance moving forward.”

“Monitoring everything from temperature to speed to voltage and being able to make deductions with this information is critical,” Schultz added. This is another way to examine your productivity without generating extra costs.”

NORD recently launched a new mobile app and a Bluetooth dongle that can plug into their systems using an Apple or Android phone to collect and monitor information.

The NORDCON App enables diagnosis, analysis, parameterization and monitoring of NORD drive systems using a mobile terminal device for service calls. Convenient and intuitive operation is presented by dashboard-based visualization, quick access to parameters and a backup and recovery feature. Drive analysis is supported by an individually configurable oscilloscope function. A Help function, video tutorials and the option for direct contact with NORD complete the app.



The NORDAC Access BT is a Bluetooth stick that is used directly with the variable frequency drive. This allows convenient mobile access to the drive status, parameter settings, and diagnostic information. The NORDAC Access BT can be used to save parameter data using the Bluetooth Stick (without using the App). Users can transfer parameters from one VFD to another. Parameter transfer between a drive and a PC is also possible.

Schultz is pleased with these new smart components, but notes that the industry is still in its infancy regarding IIoT and Industry 4.0 solutions.

“People are being cautious about these technologies, particularly from a security standpoint. Our customers are very interested, but the question is how do we successfully bring it to market, fine tune it and see how these tools can really impact their day-to-day operations?” Schultz said.

### Growing Opportunities

Nord’s systematic approach is paying off in several different areas, most notably, in material handling applications like

## PUTTING A LIFETIME

OF

## GEAR DESIGN

EXPERIENCE

TO WORK FOR YOU

- Reverse engineering
- Gearbox upgrades
- Custom gearbox design
- Specification development
- Project management
- Vendor qualification
- Design reviews
- Bid evaluations
- Tooling design
- Customized gear training
- Equipment evaluation
- Custom machine design

**Charles D. Schultz**  
**chuck@beytagear.com**  
**[630] 209-1652**

[www.beytagear.com](http://www.beytagear.com)

## Quicksilver Controls SilverMax™

### Integrated Hybrid Servos

Motor + Encoder + Controller + Driver

High Efficiency Over Wide Speed Range

Highly Programmable

Handles Large Inertia Mismatch

NEMA 23 and 34

Bringing Our 23 years of  
Hybrid Servo Expertise  
to Your Project!



+1 909 599 6291

[www.QuicksilverControls.com](http://www.QuicksilverControls.com)

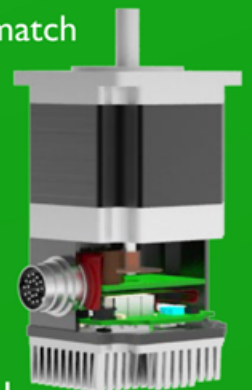

food and beverage, warehouse logistics and baggage handling.

“Airport baggage handling is one of the fastest growing segments at NORD. Over the past years, NORD has built a significant market share in this market segment,” Schultz said.

There are many engineering challenges involved in baggage handling systems including miles of conveyors, in-line CT-scan screening machines, multiple in-feed lines, four-way sorters, high-speed diverters and more. NORD has utilized its gear reducers, motors and VFDs in airports such as Charlotte, Oklahoma City, Cleveland, London, Montreal and Istanbul—to name a few.

“These global customers need engineering knowhow and the confidence that the products being utilized can do the job,” Schultz said. “NORD is really reaping the benefits after putting in years of hard work and preparing our organization for the technology changes in these markets.” He added, “Together with our success in the intralogistics and food & beverage industries, we are experiencing our third year of double-digit growth.” ([www.nord.com](http://www.nord.com))

## Forest City Gear

ADDS PROCESS ENGINEER TO ‘CUT TEETH ONLY’ OPERATIONS TEAM

Forest City Gear has added **Joe Konetski** as process engineer to its ‘Cut Teeth Only’ operations team, a resource dedicated to meeting fast-growing demand for the completion of gears made from a customer’s gear blank.

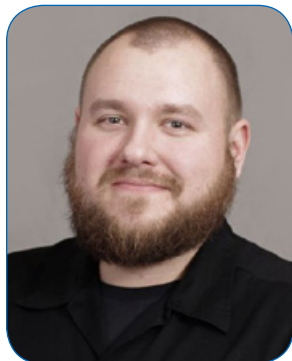

Konetski joins the Cut Teeth Only Team after serving as a setup technician for a wide variety of gear cutting and grinding machines at Forest City Gear. He is also a graduate of Forest City Gear’s four-year Apprenticeship Program, conducted in cooperation with the Rock River Valley Tooling and Machining Assoc. (RRVTMA). The program is intensive, requiring 8,000 hours of on-the-job training, and 604 hours of related training at nearby Rock Valley College, and is the ideal preparation for Konetski’s new role, says John Cochran, the Cut Teeth Only Team’s Lead person.

“We’ve cut leadtimes and streamlined production on Cut Teeth Only projects to meet unprecedented high demand with the help of a dedicated team of process engineers that takes ownership of a project from the P.O. through scheduling and production,” says Cochran. “Joe’s typical of our team: knowledgeable, experienced and, above all, able to wear a multitude of hats.” ([forestcitygear.com](http://forestcitygear.com))

## Napoleon Engineering Services

ACHIEVES NADCAP CERTIFICATION

Napoleon Engineering Services (NES) is proud to announce that it has achieved accreditation by the National Aerospace and Defense Contractors Accreditation Program (NADCAP) for Chemical Processing.

NADCAP was created in 1990 by SAE Inc. and is administered by the not-for-profit Performance Review Institute (PRI), a global provider of customer focused solutions. NADCAP provides company level accreditation based on specific processes, such as chemical processing, used by aerospace suppliers.



This accreditation means that NES is in line with NADCAP’s standardized approach to quality assurance, which replaces routine auditing with more in-depth, technically superior, special process audits, and it demonstrates NES’s commitment to quality and safety while also providing increased customer satisfaction.

“NADCAP accreditation is an integral part of our overall commitment to the aerospace industry and the quality of the products we produce,” said Christopher Napoleon, president of NES.

NES has a strong track record of providing bearings and bearing services to the aerospace and defense industries, delivered through highly qualified staff using exceptional engineering and cutting edge technology. NES has worked hard to achieve NADCAP status as a measure of their commitment to excellence. ([www.nesbearings.com](http://www.nesbearings.com))

# Kollmorgen

ANNOUNCES NEW EMEA VICE PRESIDENT/GENERAL MANAGER

Kollmorgen announced today that **Alberto Favalessa**, formerly managing director for Italy and Switzerland, has been selected as Kollmorgen's new VP/GM of EMEA operations. His appointment is effective immediately.

Favalessa has been with Kollmorgen's EMEA sales operations since 2000 in positions of increasing responsibility. As managing director of Italy and Switzerland, Favalessa has successfully built Kollmorgen's motion control business in key industrial automation and automated guided vehicle segments. His approach to designing integrated motion solutions has made him a valued partner to key customers. His team-based approach to problem solving and continuous improvement has made him an equally trusted and respected leader within the company.

"Managing the EMEA & India regions for the leader in motion control is certainly a source of pride for me," says Favalessa. "There are few companies in the world that can boast a history of over a century of innovation and this legacy gives me great motivation. I thank the company for the trust given to me. The technologies Kollmorgen has developed for servo systems and for automated guided vehicles continue to achieve increasingly high standards for performance and reliability. These solutions provide the foundation for conversations with customers about innovation, service, and results. I look forward to driving the company's continued advancements in all of these areas."

Alberto Favalessa succeeds Markus Johansson, who leaves the Kollmorgen team well-positioned to accelerate its current positive momentum well into the future. "I can think of no one better to lead our EMEA team," says Kollmorgen President Dan St. Martin. "Over his 20-year tenure with our company, Alberto has demonstrated a passion for building strong customer relationships and solutions tailored to each customer's specific needs. Alberto has proven his ability to not only achieve business results, but also to inspire and develop our employees. We rely on his leadership and on his deep knowledge of the business and are confident he'll be successful in this latest assignment." ([www.kollmorgen.com](http://www.kollmorgen.com))



# Omron Microscan

APPOINTS PRESIDENT AND CEO

Omron recently announced **Andy Zosel** has been appointed as the new president and CEO of its Omron Microscan business located in Renton WA. Zosel joined Microscan in 1997 as a design engineer and has since held several leadership positions in customer service, marketing and engineering. Most recently, he served as senior vice



president of engineering and commercial operations for Omron Microscan. He brings a unique blend of both technical aptitude and customer focused strategic marketing. According to Nigel Blakeway, managing executive officer, chairman of Omron Management Centers of America, Europe and Asia Pacific, "Andy began his career with Microscan over 22 years ago and has progressively grown his career with the organization during this time. I am confident Andy will continue to successfully lead the organization well into the future." "Andy is a proven leader with strong engineering skills and the ability to bring people together. He represents the Omron values of innovation driven by social needs, challenging ourselves and respect for all," stated Junta Tsujinaga, managing executive officer and senior general manager, product business division industrial automation Company at Omron Corporation. "His vision for applying Omron IAB's innovative-Automation concept to Traceability solutions is exactly what Omron Microscan needs as the company enters its next chapter of growth." "I am excited about the opportunity to lead the Omron Microscan team," says Zosel. "Omron has significantly invested in engineering talent. We have a great team and a compelling roadmap of solutions that will help our customers meet the future demands of Traceability. Our focus is on delivering the next generation of Traceability solutions that will combine Automatic Identification with Omron's unique 'innovative-Automation' concept to improve total production visibility." Since the acquisition of Microscan Systems, Omron has invested in the development of new products and integrating code readers with Omron's automation technology. Omron Microscan seeks to offer comprehensive Traceability solution packages that are tailored to the challenges faced by each industry. In recent years, manufacturers have become committed to achieving more exacting traceability and enhancing governance regarding product safety. In doing so, they can respond to growing demands for product safety and security, while eliminating quality issues. Zosel will continue to be based in the Omron Microscan headquartered in Renton, Washington. ([www.omron.com](http://www.omron.com))

## Twin Disc

APPOINTS FEIERTAG AS PRESIDENT AND COO

Twin Disc, Inc., a global leader in power transmission technology for marine and land-based applications, has appointed **James E. Feiertag** as president and COO, effective May 1, 2019. Feiertag assumes the role of president, previously held by CEO John H. Batten, and replaces COO Mac Moore, who retired on May 31, 2019.



In this role, Feiertag will be responsible for overseeing the functions of operations, sales, marketing, distribution and engineering.

Since 2014, Feiertag has been president and CEO of Bemis Manufacturing Company in Sheboygan Falls, Wisconsin. Prior to that, he was employed at Twin Disc for 14 years, most recently as executive vice president. During his tenure, he had a variety of global and regional responsibilities in operations, sales and marketing, distribution, engineering and global sourcing. Prior to joining Twin Disc in 2000, Jim spent 21 years at Rockwell Automation in various roles. Feiertag earned a BBA from the University of Wisconsin-Whitewater and an MBA from Marquette University.

“We are thrilled to welcome Jim back to Twin Disc,” said John H. Batten, CEO of Twin Disc. “His leadership, knowledge and experience in our markets, coupled with his intimate knowledge of our company, will serve us well.” ([www.twindisc.com](http://www.twindisc.com))

## Varvel

REWARDS TOP STUDENT IN RACING MOTORCYCLE ENGINEERING COURSE

Commitment, competence and excellent performance are some of the key characteristics of the Varvel Group, the Bologna-based company that has been designing, manufacturing and supplying industrial gearboxes since 1955. The socially responsible Varvel Group has always invested in young people. For a number of years now, the group has also supported projects promoting collaboration between centers



of scientific learning and the manufacturing sector. As part of this commitment, this year again, Varvel is rewarding the best performing student in the masters degree course in Racing Motorcycle Engineering organized by the Bologna-based Professional Datagest higher education organization.

This partnership dates back to 2012, when Varvel helped finance two students from towns in Emilia affected by the earthquake of that year. This year, Varvel has made a tangible contribution to the seventh edition of the course, rewarding Marco Radaelli, the student who has demonstrated the greatest talent and passion, commitment and determination. Marco has excelled over intense months of theory and practice sessions, exams and tests to finish in pole position ahead of his colleagues in the masters course.

“Life is a challenge, and the real race is yet to begin,” commented Mauro Cominoli, the Varvel Group’s general manager, “but Marco has certainly shown a determination to be first across the finishing line and we are delighted to help him continue his race.” ([www.varvel.com](http://www.varvel.com))

## Huco Direct

OFFERS NEXT DAY SHIPPING FOR ONLINE ORDERS

Huco has launched an e-commerce service at the website below that allows end users to order precision couplings direct from its manufacturing headquarters. The online platform has been created to allow small-volume orders to be delivered globally, with next day shipping on standard orders. The service is ideal for design engineers or MRO operatives who frequently need parts delivered to extremely tight deadlines.



Huco, a premier brand of Altra Industrial Motion Corp., offers a variety of precision couplings for industrial and commercial applications.

The Huco Direct service allows engineers to order genuine parts direct from the manufacturer – offering quality advantages as well as reliable delivery times. Suppliers who deliver from stock often run out of popular items, which can mean customers are left waiting weeks for replenishment. Huco can ensure next day shipping for all standard orders because of its flexible manufacturing system.

Online customers can select the bore size and specify if a keyway is required before making orders to guarantee that the perfect coupling is chosen. Technical specifications for each product are included as well as a free CAD download service available to all registered users. A selection of air motors, service kits and gearboxes are also available to order online. ([www.hucoirect.com](http://www.hucoirect.com))

### September 11–12—Digital Industry USA 2019

Louisville, Kentucky. Digital Industry USA 2019 has partnered with leading industry associations to provide educational content for conference sessions and expert panels during the inaugural event. Leading industry association partners include, CSIA (Control System Integrators Association), ISA (International Society of Automation) and MESA (Manufacturing Enterprise Solutions Association) International. During the trade show's on-floor conference program, industry visionaries will showcase field experiences and case studies that feature real IIoT (Industrial Internet of Things) integration across their organizations. For more information, visit [digitalindustry.com](http://digitalindustry.com).

### September 17–19—AGMA Fundamentals of Gear Design and Analysis

Hilton Oak Lawn, Illinois. Gain a solid and fundamental understanding of gear geometry, types and arrangements, and design principles. Starting with the basic definitions of gears, conjugate motion, and the Laws of Gearing, learn the tools needed to understand the inter-relation and coordinated motion operating within gear pairs and multi-gear trains. Basic gear system design process and gear measurement and inspection techniques will also be explained. In addition, the fundamentals of understanding the step-wise process of working through the iterative design process required to generate a gear pair will be reviewed. Learn the steps and issues involved in design refinement and some manufacturing considerations. An explanation of basic gear measurement techniques, how measurement equipment and test machines implement these techniques, and how to interpret the results from these basic measurements will also be covered. The instructor is William "Mark" McVea. For more information, visit [www.agma.org](http://www.agma.org).

### September 17–19—CTI Symposium

China Shanghai, China. The next International CTI Symposium "Automotive Drivetrains, Intelligent & Electrified" will gather in China for the sixth time to exchange ideas on transmission technology developments. With lectures, presentations, keynote speeches and the satellite exhibition "Transmission Expo," the event will provide a powerful framework for high-ranking Chinese and international automobile and transmission manufacturers and suppliers. The focus will rest on strategies, new components and development tools for conventional and alternative drives. China is now by far the world's largest market for plug-in hybrid and electric vehicles. Supported by state programs and directives, NEVs (New Energy Vehicles) aim to cut emissions in urban conglomerations and make the land less dependent on oil imports. By 2020, the plan is to get more than five million electric automobiles on Chinese roads. For more information, visit [drivetrain-symposium.world/cn/registration/](http://drivetrain-symposium.world/cn/registration/).

### October 7–10—Gear Dynamics and Gear Noise Short Course

Ohio State University, Columbus, Ohio. The purpose of this unique short course is to provide a better understanding of the mechanisms of gear noise generation, methods by which gear noise is measured and predicted and techniques employed in gear noise and vibration reduction. Over the past 37 years more than 1,950 engineers and technicians from over 360 companies have attended the Gear Noise Short Course. A popular fea-

ture of this course is the interspersing of demonstrations with lectures. The extensive measurement and computer software capabilities of the Gear and Power Transmission Research Laboratory allow instructors to do this in a simple and non-commercial manner. The Case History Workshop (Day 3) allows course instructors and participants to interact and to discuss gear noise and dynamics case histories presented by course attendees. Throughout the course, laboratory and computer software demonstrations are used to illustrate gear noise measurement and analysis techniques. The facilities of the Gear and Power Transmission Research Laboratory and the Acoustics and Dynamics Laboratory are used for these demonstrations. For more information, visit [www.nvhgear.org](http://www.nvhgear.org).

### October 15–17—Motion + Power Technology Expo

Cobo Hall, Detroit, Michigan. The Motion + Power Technology Expo (formerly Gear Expo) connects the top manufacturers, suppliers, buyers, and experts in the mechanical, electrical, and fluid power industries. Over three action-packed days in Detroit, end-users can shop the latest technology, products and services, and compare benefits side-by-side. Prominent exhibitors will conduct demos and host information-rich seminars as well as offer-up technical expertise. The education courses at the Motion + Power Technology Expo offer exclusive access to a wide-ranging series of technical seminars taught by industry leaders and insiders. For more information, visit [www.motionpowerexpo.com](http://www.motionpowerexpo.com).

### October 22–24—SouthTec 2019

TD Convention Center, Greenville, S.C. South-Tec draws manufacturing suppliers, distributors and equipment builders from across North America and around the world - bringing them together in Greenville, South Carolina. With hundreds of exhibiting companies, attendees can find all the latest technologies and services - plus the experts who build them - ready to demonstrate solutions that can help them grow their business. Visitors can make side-by-side comparisons, discover integrated equipment, hear about industry trends and forecasts, and leverage their purchasing power. For more information, visit [www.southteconline.com](http://www.southteconline.com).

### October 30–31—Advanced Engineering 2019

Birmingham, United Kingdom. Advanced Engineering continues to build even further upon its position as the UK's largest annual gathering of OEMs and engineering supply chain professionals. Advanced Engineering provides a platform for knowledge transfer and business discussions across: R & D, design, test, measurement & inspection, raw materials & processing, manufacturing, production and automation. The 2019 edition features co-located shows such as Aero Engineering, Composites Engineering, Automotive Engineering, Performance Metals, Connected Manufacturing and Medical Device Engineering. Lab Innovations is the UK's only show dedicated to the entire laboratory industry. For more information, visit [www.easyfairs.com/advanced-engineering-2019/advanced-engineering-2019/](http://www.easyfairs.com/advanced-engineering-2019/advanced-engineering-2019/).

# Power Transmission Engineering

## Randall Publications LLC

1840 Jarvis Avenue  
Elk Grove Village, IL 60007  
Phone: (847) 437-6604  
Fax: (847) 437-6618

### EDITORIAL

**Publisher & Editor-in-Chief**  
Michael Goldstein

[publisher@powertransmission.com](mailto:publisher@powertransmission.com)

**Managing Editor & Associate Publisher**

Randy Stott

[wrs@powertransmission.com](mailto:wrs@powertransmission.com)

**Senior Editor**

Jack McGuinn

[jmcguinn@powertransmission.com](mailto:jmcguinn@powertransmission.com)

**Senior Editor**

Matthew Jaster

[mjaster@powertransmission.com](mailto:mjaster@powertransmission.com)

**Associate Editor**

Alex Cannella

[alex@geartechnology.com](mailto:alex@geartechnology.com)

**Editorial Consultant**

Paul R. Goldstein

### ART

**Art Director**

David Ropinski

[dropinski@powertransmission.com](mailto:dropinski@powertransmission.com)

### ADVERTISING

**Advertising Sales Manager  
& Associate Publisher**

Dave Friedman

[dave@powertransmission.com](mailto:dave@powertransmission.com)

**eMarketing Specialist**

Matthew Stott

[matthewstott@powertransmission.com](mailto:matthewstott@powertransmission.com)

**China Sales Agent**

Eric Wu

Eastco Industry Co., Ltd.

Tel: (86)(21) 52305107

Fax: (86)(21) 52305106

Cell: (86) 13817160576

[eric.wu@eastcotec.com](mailto:eric.wu@eastcotec.com)

**Materials Coordinator**

Dorothy Fiandaca

[dee@randallpublications.com](mailto:dee@randallpublications.com)

### CIRCULATION

**Circulation Manager**

Carol Tratar

[subscribe@powertransmission.com](mailto:subscribe@powertransmission.com)

**Circulation Coordinator**

Barbara Novak

[bnovak@powertransmission.com](mailto:bnovak@powertransmission.com)

### RANDALL PUBLICATIONS STAFF

**President**

Michael Goldstein

**Accounting**

Luann Harrod

## ABB

Page 3

[baldor.abb.com](http://baldor.abb.com)

## AGMA

Page 11

[MotionPowerExpo.com](http://MotionPowerExpo.com)

## Andantex USA Inc.

Page 18

[andantex.com](http://andantex.com)

## B&R Machine and Gear

Page 39

[www.brgear.com](http://www.brgear.com)

## Beyta Gear Service

Page 57

[www.beytagear.com](http://www.beytagear.com)

## Brother International

Front Cover, Inside Front Cover

[www.brothergearmotors.com](http://www.brothergearmotors.com)

## Circle Gear

Page 16

[www.circlegear.com](http://www.circlegear.com)

## Designatronics

Page 19

[www.sdp-si.com](http://www.sdp-si.com)

## Diequa Corp.

Pages 20, 39

[www.diequa.com](http://www.diequa.com)

## Forest City Gear

Page 15

[www.forestcitygear.com](http://www.forestcitygear.com)

## ITW Heartland

Page 23

[SpiroidGearing.com](http://SpiroidGearing.com)

## J.W. Winco

Page 40

[www.jwwinco.com](http://www.jwwinco.com)

## JIE USA

Page 41

[www.jie-drives.com](http://www.jie-drives.com)

## Kyodo Yushi USA Inc.

Page 2

[www.kyodoyushiusa.com](http://www.kyodoyushiusa.com)

## Lafert North America

Page 14

[www.lafertna.com](http://www.lafertna.com)

## McInnes Rolled Rings

Page 25

[www.mcinnesrolledrings.com](http://www.mcinnesrolledrings.com)

## Molon Motor and Coil

Page 24

[www.molon.com](http://www.molon.com)

## Motion+Power Technology Expo

Page 11

[MotionPowerExpo.com](http://MotionPowerExpo.com)

## NORD Drivesystems

Page 4

[Benefits.myNORD.com](http://Benefits.myNORD.com)

## Nordex Inc.

Page 40

[www.nordex.com](http://www.nordex.com)

## Philadelphia Gear

Page 13

[PhilaGear.com/MyMission](http://PhilaGear.com/MyMission)

## Quicksilver Controls

Page 57

[www.QuickSilverControls.com](http://www.QuickSilverControls.com)

## R+W America

Pages 7, 31

[www.rw-america.com](http://www.rw-america.com)

## RBI Bearing Inc.

Page 5

[www.rbibearing.com](http://www.rbibearing.com)

## Schaeffler Group

Back Outside Cover

[www.schaeffler.us](http://www.schaeffler.us)

## SDP/SI

Page 19

[www.sdp-si.com](http://www.sdp-si.com)

## SEW-Eurodrive

Inside Back Cover

[www.seweurodrive.com](http://www.seweurodrive.com)

## SMT

Page 21

[masta.smartmt.com](http://masta.smartmt.com)

## U.S. Tsubaki Power Transmission

Page 12

[ustsubaki.com](http://ustsubaki.com)

## WEG Electric Corp.

Page 17

[www.weg.net](http://www.weg.net)

## Zero-Max

Pages 9, 30

[www.zero-max.com](http://www.zero-max.com)



**YES** I want to receive/continue to receive *Power Transmission Engineering*

**NO** Thanks anyway, but I don't need the world's best publication on mechanical components.

Name \_\_\_\_\_ Job Title \_\_\_\_\_  
(please print)

Signature \_\_\_\_\_ Date \_\_\_\_\_  
(required)

## How would you like to receive *Power Transmission Engineering*?

- PRINT Version (Verify mailing info below)
- DIGITAL Version (E-mail required)
- BOTH Print AND Digital (E-mail required)

E-mail \_\_\_\_\_ \*

## How is THIS LOCATION involved with power transmission products? (Check all that apply)

- WE MAKE power transmission products
- WE BUY power transmission products
- WE SELL power transmission products (Distributors, sales reps, etc.)
- WE DESIGN products with power transmission components in them
- Other (please describe) \_\_\_\_\_

What is your company's principal product or service? \_\_\_\_\_  
\_\_\_\_\_

**\*Your PRIVACY is important to us. You get to CHOOSE how we use your personal information. The next e-mail we send you will have clear instructions.**

## MAILING INFORMATION

NAME:

JOB TITLE:

COMPANY:

ADDRESS:

- Check if this is a home address

CITY:

STATE/Province:

ZIP/Postal Code:

PHONE:

FAX:

Put your business card here to make it easier!

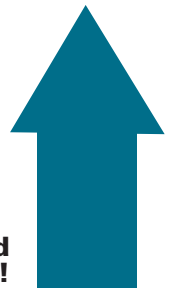

Mail to:  
1840 Jarvis Ave., Elk Grove Village, IL 60007 USA

or

FAX to 1-847-437-6618  
SCAN to: [subscribe@powertransmission.com](mailto:subscribe@powertransmission.com)

# Renewable Building Blocks

## LEGO & Vestas Collaborate on Sustainability Project

Matthew Jaster, Senior Editor

### Ambition is thy name when it comes to LEGO sets.

What other company offers incredibly authentic replicas of the Walt Disney Castle, the Eiffel Tower, the Sydney Opera House and the Death Star? LEGO goes above and beyond when it comes to imagination and attention-to-detail. I've been in awe of the company's vast creativity since receiving the 702-piece Black Monarch's Castle back in the late 1980s.

You can now add renewable energy and sustainability to LEGO's list of accomplishments.

LEGO released a public version of its Creator Expert Vestas Wind Turbine set in the fall of 2018 to celebrate play, creativity and imagination while raising awareness about sustainability and renewable energy in partnership with Vestas. This is the very first set available to purchase that features one of the all-new sustainably sourced plant-based plastic LEGO elements, Plants from Plants.

Jakob Christiansen, Vestas senior specialist, brand management and creative for the global marketing and public affairs department, recently spoke to *PTE* about the unique LEGO set.

"The original version of the LEGO Vestas Wind Turbine set was introduced in 2008, but only for Vestas



employees and as a gift for our customers," Christiansen said. "It was loosely based on our V90-3.0 MW wind turbine."

Due to popular demand, the wind turbine set was released to the general public for purchase in the fall of 2018. The 826-piece model stands nearly a meter-high towering over a wooded hill, featuring the new 'Plants from Plants' spruce tree. Made from plant-based plastic sourced from sugarcane, the inclusion of these elements is part of the first steps in the LEGO Group's ambition to use sustainable materials in products by 2030 and packaging by 2025.

"Today, wind energy is the cheapest source of energy in many markets, which have made wind turbines a sustainability icon across the globe and we are proud to partner with the LEGO Group on this relaunch. The original Vestas wind turbine LEGO model was specially created for Vestas to promote wind energy to a small audience within energy and the relaunch to the global LEGO community tells the story of how wind energy has gone from niche to mainstream, not just within energy but the entire world," said Morten Dyrholm, group senior vice president of marketing, communications and public affairs at Vestas.

The set measures 100 cm high, 72 cm wide and 31 cm deep and features adjustable wind blades (not as big as the real thing, of course), detailed tower, movable nacelle with aircraft warning lights, and power functions to automate the set. According to Christiansen, the set takes roughly four hours to build.

Last December, Vestas France launched the #VestasLegoChallenge campaign.

"The company sent a Vestas Lego WTG to 100 relevant French wind market stakeholders (developers, utilities, lawyers, technical advisors, etc.),



challenging them to video the making of the toy turbine with their teams and then share it on their social media channels," Christiansen said.

The impact and visibility of the campaign in Vestas France has been noteworthy. One month after the launch of the initiative, more than 40 videos were created, giving place to over 30 posts on LinkedIn and other social media channels.

"The hashtag #VestasLegoChallenge has been also shared by people who are not members of the wind industry which shows the important impact of the challenge," Christiansen added.

This latest instalment in the LEGO Creator Expert Series has been designed to provide a challenging and rewarding building experience with a touch of nostalgia, with builders discovering a house complete with a furnished patio and a working porch light and powered wind turbine, as well as three LEGO Vestas servicemen mini-figures and a LEGO dog.

So, the challenge is on *PTE* readers. Visit the website below to put together this engineering marvel. Here's to 826 LEGO pieces, all in the name of renewable energy and sustainability. **PTE**

[shop.lego.com/en-US/product/Vestas-Wind-Turbine-10268](http://shop.lego.com/en-US/product/Vestas-Wind-Turbine-10268)

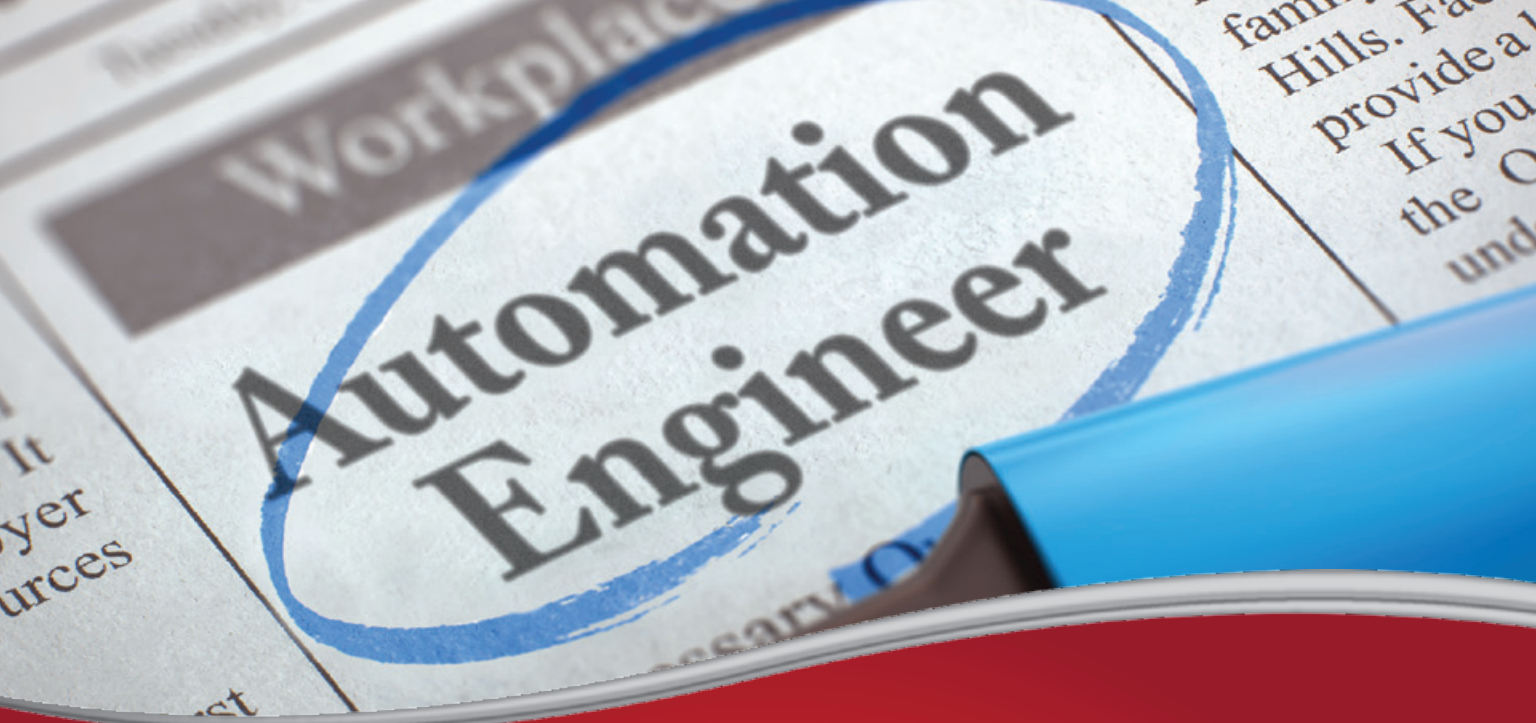

# Automation Engineer

## Need experience?

**Problem:** You can't recruit or retain experienced motion control engineers.

**Solution:** Contact an automation specialist at SEW-EURODRIVE. Using the latest innovation, we provide a **complete package** from start to finish, including project planning, design, components, software, commissioning, and worldwide support.

Think of our specialists as an extension of your staff . . .



**SEW**  
**EURODRIVE**

# X-life™ Metric Tapered Roller Bearings: Best-in-Class Precision



**FAG**

Compared to the conventional standard, FAG X-life tapered roller bearings from Schaeffler deliver up to 20 percent higher basic dynamic load rating, as much as 75 percent less friction, and up to 70 percent longer rating life. But that's not all: FAG X-life metric tapered roller bearings offer industry-leading performance with respect to radial and axial misalignment.

In other words: Best-in-class precision for the most demanding applications. Only from Schaeffler.

[www.schaeffler.us](http://www.schaeffler.us)

©2019

**SCHAEFFLER**