

# Power Transmission Engineering®

AUGUST 2015

## ANALYSIS BY DESIGN

### TECHNICAL

[A GEOMETRICALLY ADAPTIVE APPROACH FOR TOOTH CONTACT ANALYSIS]

[EFFECTS OF CONTACT RATIOS ON MESH STIFFNESS OF HELICAL GEARS]

[THE IMPORTANCE OF THERMAL PROTECTION FOR TORQUE MOTORS]

### PLUS

PREVIEW OF PACK EXPO LAS VEGAS

# Save Money, Save Energy

with DRIVES and MOTORS from AutomationDirect



STARTING AT:  
**\$156.00**  
GS2-10P2

STARTING AT:  
**\$99.00**  
GS1-10P2

STARTING AT:  
**\$242.00**  
GS3-21P0

**NEW!**  
48V Version

STARTING AT:  
**\$115.00**  
48VDC Version  
(GSD1-12-10C)

STARTING AT:  
**\$59.00**  
GSD3-240-2CL

Variable speed drives can improve your bottom line by reducing your motors' energy consumption. An investment of as little as \$59 can start paying off immediately.



• **GS1 AC drives (1/4 to 2 hp)** offer simple Volts/ Hertz control for general purpose applications. Built-in I/O, Modbus communications capability and programmable preset speeds increase their flexibility.



• **GS2 AC drives (0.5 to 10 hp)** feature built-in PID control, dynamic braking and Modbus communications.



• **DuraPULSE AC drives (1 to 100 hp)** add sensorless vector control, a removable keypad that stores up to four different application programs and built-in discrete and analog I/O. Communicate via built-in Modbus or an optional Ethernet connection.



**IRONHORSE**

• **Ironhorse DC drives** can accommodate 1/50 HP @ 12VDC all the way up to 3HP @ 240VAC. These drives deliver excellent low speed control and stability and are easily configured for your application.

• **NEW!** 48VDC version now available with jumper selectable (12V, 24V, 36V or 48V) operating voltage.

Research, price, and buy at: [www.automationdirect.com/drives](http://www.automationdirect.com/drives)

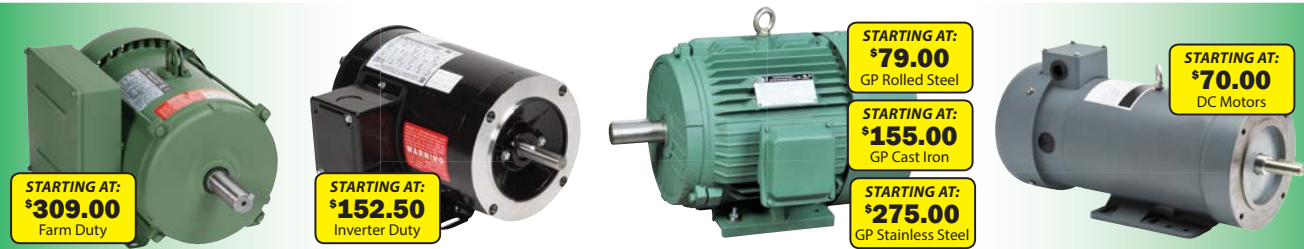

STARTING AT:  
**\$309.00**  
Farm Duty

STARTING AT:  
**\$152.50**  
Inverter Duty

STARTING AT:  
**\$79.00**  
GP Rolled Steel

STARTING AT:  
**\$155.00**  
GP Cast Iron

STARTING AT:  
**\$275.00**  
GP Stainless Steel

STARTING AT:  
**\$70.00**  
DC Motors

With a huge selection of high-quality industrial electric motors and the lowest prices to go with them, we have what you are looking for!



- Inverter/Vector duty (1/4 to 100 hp)
- 1200 and 1800 RPM base speeds
- Dual 230/460V and 575 VAC models
- Factory-mounted encoders on select models
- **NEMA Premium Efficiency XRI series** from 1 to 10 hp (compliant with Energy Independence and Security Act of 2007)



**IRONHORSE**

- Rolled steel, general purpose (1/3 to 2 hp)
- Stainless steel, general purpose (1/3 to 2 hp)
- Cast iron, general purpose (1 to 300 hp)
- Farm duty (2 to 5 hp)
- 1800 RPM with 1200 and 3600 RPM units available in the most popular horsepower ratings
- Premium efficiency models meet current NEMA standards from 1 to 150 hp
- Ironhorse DC motors are available in TENV and TEFC rolled steel enclosure styles. Their space-saving designs feature a NEMA 56C flange and removable mounting base.

Research, price, and buy at: [www.automationdirect.com/motors](http://www.automationdirect.com/motors)



**Order Today, Ships Today!**

\*See our Web site for details and restrictions. © Copyright 2014 AutomationDirect, Cumming, GA USA. All rights reserved.



**AUTOMATIONDIRECT**.com

**1-800-633-0405**

the #1 value in automation

# Power Transmission Engineering®

AUGUST 2015

[20]



[26]

## FEATURE ARTICLES

- [20] **Braking the Cycle**  
Oak Crest Lumber's Switch to Oil Shear Clutch-Brakes Yields Years of Trouble-Free Service.
- [24] **The Race for Efficiency**  
The high-efficiency motor market is racing ahead of legislation — and the rest of us need to catch up.
- [26] **Are You Not Entertained?**  
Pack Expo Las Vegas promises to be insightful and educational — and fun, too.
- [30] **Powder Metallurgy Awards**  
Winners of the 2015 Powder Metallurgy Design Excellence Awards Competition.

## TECHNICAL ARTICLES

- [34] **Ask the Expert**  
Couplings or Belts?
- [36] **A New Geometrically Adaptive Approach for Tooth Contact Analysis of Gear Drives**  
Influences of various gear parameters on the mesh stiffness are investigated by using FE methods.
- [42] **The Importance of Thermal Protection for Torque Motors**  
Some possible methods for ensuring optimum motor protection.
- [46] **Effects of Contact Ratios on Mesh Stiffness of Helical Gears for Lower Noise Design**  
Influences of various gear parameters on mesh stiffness are systematically investigated via FEM.

Vol. 9, No. 5. POWER TRANSMISSION ENGINEERING (ISSN 2331-2483) is published monthly except in January, May, July and November by Randall Publications LLC, 1840 Jarvis Ave., Elk Grove Village, IL 60007, (847) 437-6604. Cover price \$7.00. U.S. Application to Mail at Periodicals Postage Prices is Pending at Palatine, IL and at additional mailing offices. Send address changes to POWER TRANSMISSION ENGINEERING, 1840 Jarvis Ave., Elk Grove Village, IL 60007.

Randall Publications LLC makes every effort to ensure that the processes described in POWER TRANSMISSION ENGINEERING conform to sound engineering practice. Neither the authors nor the publisher can be held responsible for injuries sustained while following the procedures described. Postmaster: Send address changes to POWER TRANSMISSION ENGINEERING, 1840 Jarvis Avenue, Elk Grove Village, IL, 60007. ©2015 Contents copyrighted by RANDALL PUBLICATIONS, LLC. No part of this publication may be reproduced or transmitted in any form or by any means, electronic or mechanical, including photocopying, recording, or by any information storage and retrieval system, without permission in writing from the publisher. Contents of ads are subject to Publisher's approval.

# SERVO GEAR REDUCER

## Sesame Motor Planetary Gear Reducer

PB series are quality, cost effective solutions for precise and reliable servo motion applications. IP65 enclosure with synthetic lubricant benefits maintenance-free service life. Mounting brackets are ready to any servo motor or customized by demand.

- Backlash 15 arc-min. or less
- Max. ratio 729:1
- Optimum sealing, quiet running
- 3 frame sizes, 2 mounting flanges
- Service life lubricant



S6488  
Sept. 28-30



Hall3, L12  
Oct. 5-10



SESAME MOTOR CORP.

MOTOR | GEAR MOTOR | SERVO GEAR REDUCER | ACTUATOR  
[www.sesamemotor.com](http://www.sesamemotor.com)



## Power Transmission & Linkage Components



SEE US AT PACK EXPO BOOTH S-6411



Scan to see these products

J.W. Winco offers power transmission components as part of its immense offering of standard machine components for industry. Explore our full line on our website [www.jwwinco.com](http://www.jwwinco.com) or contact us with your application requirements.

2815 S. Calhoun Road  
New Berlin, WI 53151  
Phone: 800-877-8351  
Fax: 800-472-0670  
Sales@jwwinco.com



J.W. WINCO, INC.

# Power Transmission Engineering

VOL. 9, NO. 5

- [04] **PTEExtras**  
A completely redesigned [powertransmission.com](http://powertransmission.com).
- [06] **Publisher's page**  
Everything's Related.
- [08] **Product News**  
The newest hardware and software.
- [52] **Global Investment Outlook**  
Kind of Sluggish.
- [54] **Industry News**  
News you should know; comings, goings...
- [60] **Calendar of Events**  
**September 13-15:** TECHINDIA 2015, Bombay Exhibition Centre, Mumbai, India.  
**September 21-23:** Gear Failure Analysis seminar, Big Sky Resort, Big Sky, MT.  
**September 29-October 1:** Gear Manufacturing seminar, Hyatt Regency, Rochester, NY.  
**October 20-22:** Gear Expo 2015, Cobo Center, Detroit, MI.
- [62] **Advertiser Index**  
Every Advertiser, page-by-page.
- [63] **Subscriptions**  
Free subscriptions, anywhere in the world.
- [64] **Power Play**  
This Tattoo Machine is Off the Chain.



# Can your gearbox go the distance?



## Optimize driveline performance with SKF bearings and more.

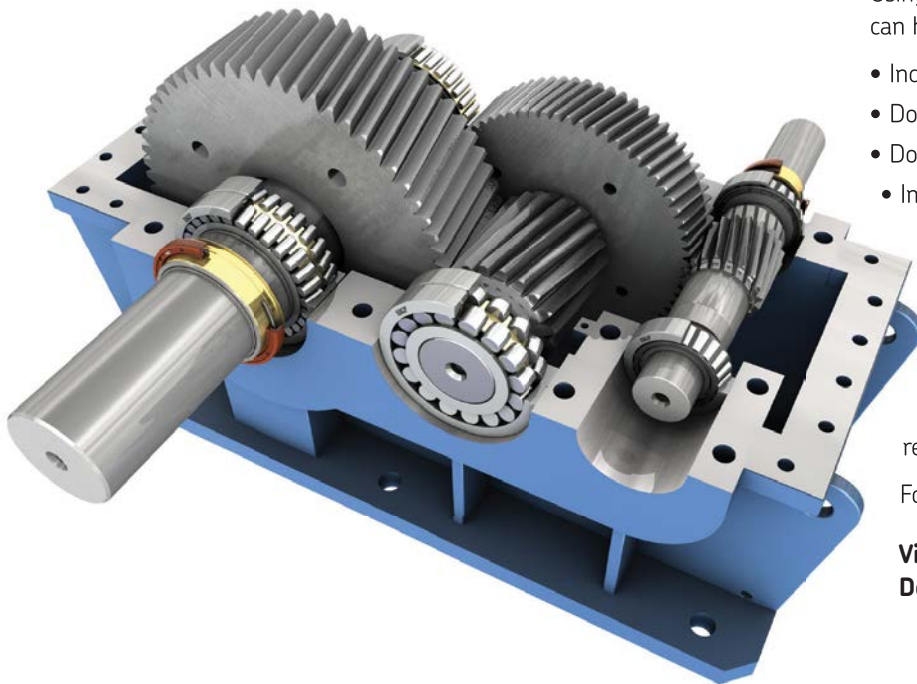

SKF optimizes transmission performance and reliability for manufacturers and end users alike. Using the SKF Life Cycle Management approach, we can help you

- Increase torque
- Downsize designs
- Double bearing service life
- Improve energy efficiency
  - Increase reliability
  - Reduce energy use

We help you reach these goals with a complete range of gearbox solutions – from upgraded SKF Explorer spherical roller bearings to commissioning, repair and remanufacturing services and much more.

For more information, visit [skf.com](http://skf.com).

**Visit us at Gear Expo 2015, October 20-22, Detroit, Booth 1042**

The Power of Knowledge Engineering

© SKF and SKF Explorer are registered trademarks of the SKF Group | © SKF Group 2015

**SKF**®

A Smarter Powertransmission.com

We've created a cleaner, sleeker more user-friendly online experience by completely redesigning the *Power Transmission Engineering* website. Go to [www.powertransmission.com](http://www.powertransmission.com) to see how much easier it is to find what you're looking for!

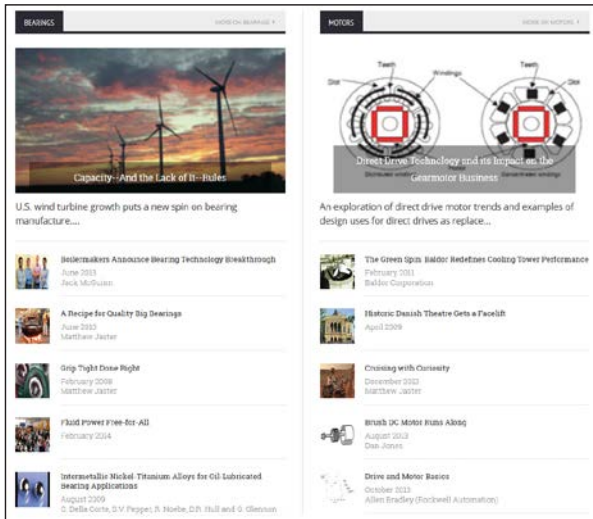
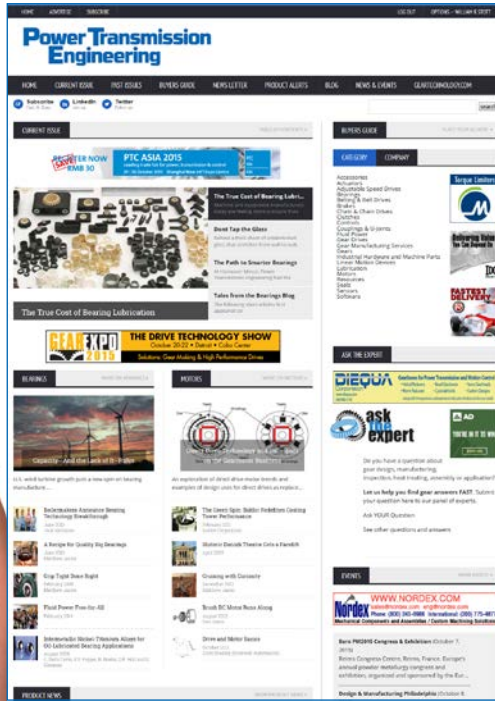
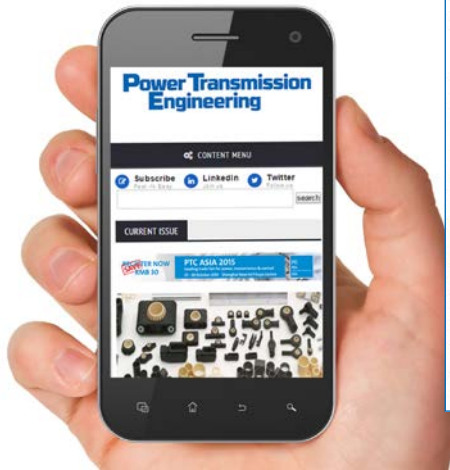

As part of the redesign, we'll be including some "FEATURED TOPICS" on the home page each month. It's our way of bringing to your attention all the great articles in our archive. This month's featured topics are "Bearings" and "Motors"

Stay Connected



Follow us on Twitter  
[twitter.com/#!/PowerTransMag](https://twitter.com/#!/PowerTransMag)



Connect with us on LinkedIn  
[www.linkedin.com/groups/Power-Transmission-Engineering-PTE-2950055](http://www.linkedin.com/groups/Power-Transmission-Engineering-PTE-2950055)



Subscribe Online  
[www.powertransmission.com/subscribe.htm](http://www.powertransmission.com/subscribe.htm)

Power Transmission Engineering

**Randall Publications LLC**  
1840 Jarvis Avenue  
Elk Grove Village, IL 60007  
Phone: (847) 437-6604  
Fax: (847) 437-6618

**EDITORIAL**

**Publisher & Editor-in-Chief**  
Michael Goldstein

[publisher@powertransmission.com](mailto:publisher@powertransmission.com)

**Managing Editor & Associate Publisher**

Randy Stott

[wrs@powertransmission.com](mailto:wrs@powertransmission.com)

**Senior Editor**

Jack McGuinn

[jmcguinn@powertransmission.com](mailto:jmcguinn@powertransmission.com)

**Assistant Editor**

Erik Schmidt

[erik@geartechology.com](mailto:erik@geartechology.com)

**News Editor**

Alex Cannella

[alex@geartechology.com](mailto:alex@geartechology.com)

**Editorial Consultant**

Paul R. Goldstein

**ART**

**Art Director**

David Ropinski

[dropski@powertransmission.com](mailto:dropski@powertransmission.com)

**ADVERTISING**

**Advertising Sales Manager & Associate Publisher**

Dave Friedman

[dave@powertransmission.com](mailto:dave@powertransmission.com)

**China Sales Agent**

Eric Wu

Eastco Industry Co., Ltd.

Tel: (86)(21) 52305107

Fax: (86)(21) 52305106

Cell: (86) 13817160576

[eric.wu@eastcotec.com](mailto:eric.wu@eastcotec.com)

**Materials Coordinator**

Dorothy Fiandaca

[dee@randallpublications.com](mailto:dee@randallpublications.com)

**DIGITAL**

**Content Manager**

Kirk Sturgulewski

[kirk@powertransmission.com](mailto:kirk@powertransmission.com)

**CIRCULATION**

**Circulation Manager**

Carol Tratar

[subscribe@powertransmission.com](mailto:subscribe@powertransmission.com)

**Circulation Coordinator**

Barbara Novak

[bnovak@powertransmission.com](mailto:bnovak@powertransmission.com)

**RANDALL PUBLICATIONS STAFF**

**President**

Michael Goldstein

**Accounting**

Luann Harrold



# YOU Count on, Brands People You Trust

Rexnord's new Thomas® XTSR52 and XTSR71 Disc Couplings provide the highest value solution for rotating equipment, including higher torque, lower mass and an all-metric design. Combining compact size and powerful performance, the Thomas XTSR Disc Couplings feature simple installation and maintenance, and strengthened operation and safety.



And, you can find **Rexnord's** Thomas Disc Couplings at your local **Motion Industries** location. Our local sales and service specialists are experts in application and technical support, providing the parts and the know-how you need to stay up and running.



Scan this code with your smartphone for more information.

<http://esp.to/wMmYFn>

The brands you count on from the people you trust...that's **Rexnord** and **Motion Industries**.



**Call.** 800-526-9328  
**Click.** [www.MotionIndustries.com](http://www.MotionIndustries.com)  
**Visit.** Over 550 Locations



Over 550 locations | More than 5.6 million products | Industrial maintenance training courses

©2015 Motion Industries, Inc.

# Everything's Related

We've recently completed a major redesign of the *powertransmission.com* website.

I know what you're thinking. Big deal, right? Websites are redesigned every day. It's not really news. You're right, of course. We're *in* the news business, and when companies send *us* press releases about their newly redesigned websites, our first instinct as editors is to respond the same way. So what. Big deal. Moving on.

So why am I making a big deal about our *own* redesign? Well, for starters, it's not so much about the look and feel of the website – although, believe me, those are vastly improved. It's more about the information, how it's organized and how you can access it. And since our job is to give you the best possible information on mechanical power transmission components and motion control, I figure it's part of my job to tell you about the best ways to get that information.

Over the past eight years, we've accumulated some really good content in *PTE*, and although we like to believe that all of you read the magazine religiously, we acknowledge that some of you might have missed an issue or two along the way. But fear not. One of the ways we've tried to help you find this valuable past information is through the new focused content areas on our home page. Each month, we'll highlight some specific subjects where we think the archives contain valuable articles. Right now, if you go to the site, you'll see "Bearings" and "Motors" as our featured topics on the home page. Under those headings you'll see a small selection of relevant articles, as well as links to even more.

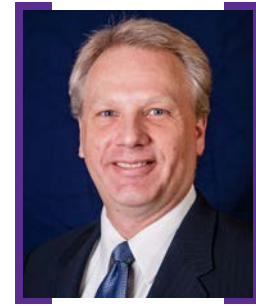

Of course, you could simply type "Bearings" or "Motors" into the search box on any page, and you'd get to the same articles. Or maybe you're interested in "Linear Motion" or "Efficiency." Just type what you're looking for into the search box.

Because all of our articles are tagged with keywords, we're also able to suggest related articles, news items and other content on our site. So, if you happen to be online reading this issue's article on motor efficiency, you'll find quick links to other articles on both motors and efficiency. You'll even find links to relevant categories and companies in our comprehensive online buyers guide. Everything's related.

In addition to all these changes, we've also made sure that the site is properly formatted for mobile devices. That way, you'll get the same great experience no matter if you're visiting *powertransmission.com* by using your desktop, your tablet or your mobile phone.

As I said earlier, our job is to get the information in your hands. The latest version of *powertransmission.com* is a giant step forward. But if you have any other suggestions about how we can do that job better – in terms of specific content, the way it's presented or how to find it – we'd love to hear them. Send your ideas and comments to [wrs@powertransmission.com](mailto:wrs@powertransmission.com).

The screenshot shows the homepage of Power Transmission Engineering. At the top, there are navigation links for HOME, ADVERTISE, SUBSCRIBE, REGISTER, and LOGIN. The main header features the site logo and a secondary navigation bar with links for HOME, CURRENT ISSUE, PAST ISSUES, BUYERS GUIDE, NEWS LETTER, PRODUCT ALERTS, BLOG, NEWS & EVENTS, and GEARTECHNOLOGY.COM. Below the header, there are social media icons for Subscribe, LinkedIn, and Twitter. The main content area includes a featured article titled "The True Cost of Bearing Lubrication" with a sub-headline "Dont Tap the Glass" and a description: "Behind a thick sheet of unblemished glass that stretches from wall to wall, ceiling to floor at". There is also a section for "The Path to Smarter Bearings" and "Tales from the Bearings Blog". On the right side, there is a "BUYERS GUIDE" section with a search bar and a list of categories including Accessories, Actuators, Adjustable Speed Drives, Bearings, Belting & Belt Drives, Brakes, Chain & Chain Drives, Clutches, Controls, Couplings & U-joints, Fluid Power, Gear Drives, Gear Manufacturing Services, Gears, Industrial Hardware and Machine Parts, Linear Motion Devices, Lubrication, Motors, Resources, Seals, Sensors, and Software. There are also advertisements for "PTC ASIA 2015" and "THE DRIVE TECHNOLOGY SHOW".



# MASTA

*Empowering engineers to achieve new levels of quality in a fraction of the time!*

AUTOMOTIVE | ENERGY | AEROSPACE | MARINE | INDUSTRIAL

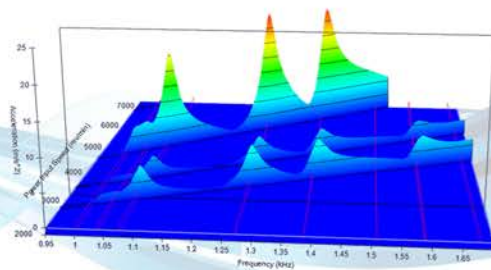
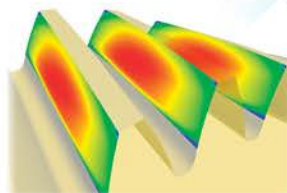
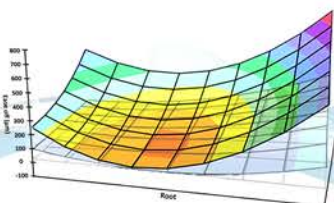

**GEAREXPO**  
**2015**  
EXHIBITOR  
THE DRIVE TECHNOLOGY SHOW

Visit our demonstration stand at booth 2207

- Accurately and rapidly design transmission systems from scratch or imported concepts
- Comprehensively understand the life of a mechanical part over the customer duty cycle
- Identify potential failure modes early in the product development cycle
- Rapidly predict key performance characteristics at the design stage
- Easily explore changes in transmission layout, component selection and/or design, materials and manufacturing processes in the convenience of a virtual environment
- Perform full system simulations for any transmission or driveline configuration
- Incorporate manufacturing simulation at the design stage to reduce process development time & cost

Evaluate our software and discover for yourself

Call +44 (0)115 941 9839  
or visit [masta.smartmt.com](http://masta.smartmt.com)

**SMT**   
SMART MANUFACTURING TECHNOLOGY

## Pittman Motors EC042B Brushless DC Motor

DESIGNED AS AN ECONOMICAL, HIGH-PERFORMANCE GENERAL PURPOSE SERVO MOTOR

Pittman Motors recently introduced the EC042B brushless DC motor series, its latest DC brushless motor.

The high torque density model is designed as an economical, yet higher performance, general purpose servo motor. Its Nema 17 mounting configuration is adaptable to most metric mounting requirements.

The EC042B motor is available in three motor lengths with a continuous torque range of 11 Ncm – 31 Ncm and a peak torque range of 35 Ncm – 99 Ncm. The EC042B has a maximum speed of 9,000 RPM and can be used with DC bus voltages up to 96 volts. There are eight standard winding variations to suit most every application. Custom windings are available.

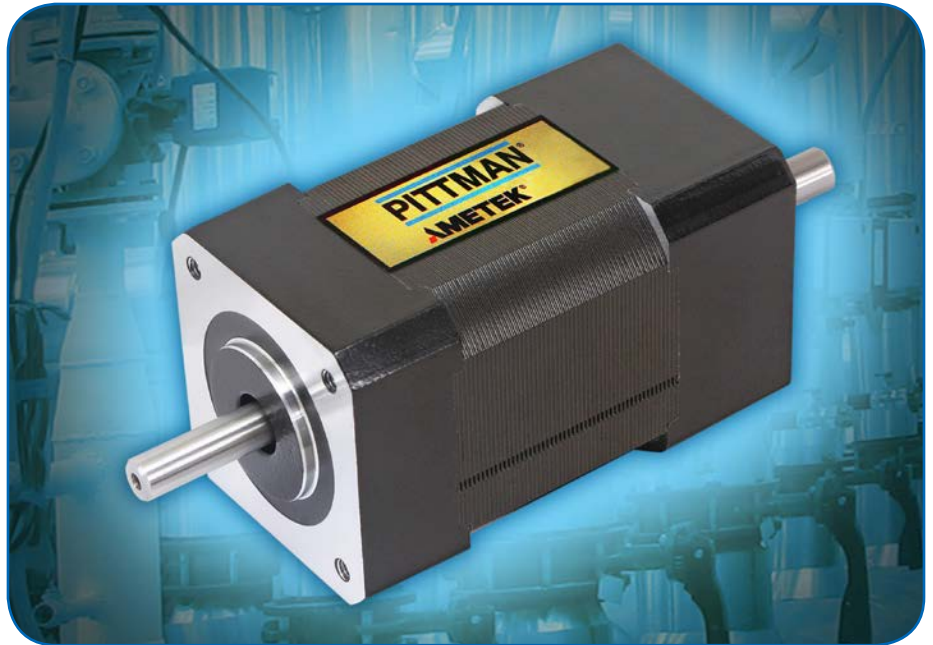

The EC042B's motor construction features a high-energy, 4-pole rotor with rare earth magnets for a high torque to inertia ratio. The stator assembly is designed with low-loss materials for higher-speed applications. The motor shaft is supported by shielded ball bearings that are preloaded for low vibration and quiet operation.

EC042B motors are available with optional Pittman PLG42S and PLG52S planetary gearboxes. Optical incremental encoders also are an option with line counts up to 2048, three channels, and line driver.

**For more information:**

Phone: (267) 933-2105  
[www.Pittman-Motors.com](http://www.Pittman-Motors.com)

## Festo Bionic Learning Network

SHOWS OFF THREE NEW TECHNOLOGIES

Festo recently introduced featured developments for 2015 in the company's Bionic Learning Network—the basic research effort designed to use biomimicry and emerging technologies, like superconductors, to make automated processes even more efficient and productive.

This year's projects were designed to illustrate how individual systems can

use communication to merge into an intelligent overall system, and how the intelligence of decentralized systems contributes to this process.

The technology carrier BionicANTS uses the cooperative behavior of ants as a model. Engineers from Festo used regulation algorithms to transfer the behavior of these insects to the world of technology. Just like their models

from nature, the BionicANTS cooperate in accordance with clearly defined rules. This enables the BionicANTS to react autonomously to different situations as individual units, to coordinate their behavior with each other, and to perform actions as a networked overall system. By pushing and pulling in a coordinated manner, BionicANTS shift loads that one ant could not move alone. All actions are based on a distributed catalog of rules that was devised in advance by means of mathematical model building and simulations and then programmed into each ant. The individual insects are thus able to make decisions autonomously, while nevertheless subordinating themselves to the common aim; each ant thus contributes its share to solving the task at hand.

The required exchange of information between the ants is conducted





# Gearing your past to power your future.



## Breakdown Services

We understand the urgency of meeting critical deadlines. We offer our customers expedited services without sacrificing quality.

## Heat Treatment

Our in-house heat treat facility performs a full range of services that include annealing, carburizing, and thru hardening.



B&R Machine and Gear Corporation is a full service gear manufacturing facility driven to power your equipment with reliable and durable gears that are built to perform and last. Find the perfect mesh. No matter the gear, we've got you covered.

VISIT OUR WEBSITE [BRGEAR.COM](http://BRGEAR.COM) FOR MORE INFORMATION



**Nordex**<sup>®</sup>  
INCORPORATED  
*Turnkey solutions with a  
higher level of intelligence*

**WWW.NORDEX.COM**

**sales@nordex.com**

Phone: (800) 243-0986

Or Call: (203) 775-4877

## THE PERFECT GEARED-ASSEMBLY

For your Medical, Laboratory,  
Instrument, Robotics, Semi-  
Conductor, Automation or other  
Precision application



## CUSTOM SOLUTIONS

Fully integrated, turnkey solutions  
including manufacturing,  
engineering, assembly, testing and  
custom machining

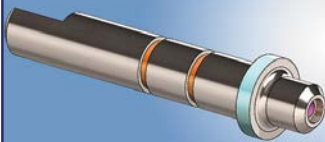

## STOCK SOLUTIONS

Choose from over 31,000 standard  
components, including bearings,  
belts, couplings, fasteners, gears,  
gearboxes, linear motion, racks,  
sprockets, worms and more

**QUALITY SOLUTIONS  
SINCE 1960**

via radio modules in each torso. The regulation strategy comprises a multi-agent system, in which the participants have equal rights. With the 3D stereo camera in their heads, the ants recognize an object to be grasped and can determine their own locations.

To manufacture BionicANTS, laser-sintered components are fitted with visible circuit structures in a Molded Interconnect Device (3D MID) process. The electrical circuitry is attached to the outer surface of the components, which assumes both a structural and an electrical function.

BionicANTS are fitted with piezo-ceramic bending transducers in their mouthparts for gripping objects, and also for their leg movements. When the upper bending transducer is deformed, the ant raises its leg. With a lower pair of piezo elements, each leg can be precisely moved forward or backwards.

The bionic butterflies likewise illustrate complex topics from the world of future production such as functional integration, ultra-lightweight construction, and real-time optimized networked communication between individual systems.

An external, networked guidance and monitoring system coordinates the individual eMotionButterflies autonomously and safely in three-dimensional space. The communication and sensor technology used constitutes an indoor GPS system that controls the butterflies' collective movement. The combination of integrated electronics and external camera technology using a host computer ensures process stability. To emulate the flight behavior of butterflies as closely as possible, the artificial butterflies are fitted with integrated electronics. These control the wings precisely and individually to effect the rapid flight movements.

A human pilot is not required to control the eMotionButterflies. Pre-programmed flight paths for the bionic

butterflies' maneuvers are stored on the host computer. By means of additionally stored behavior patterns, however, they can also fly autonomously. In this case, there is no direct communication between the eMotionButterflies. In devising the control system for the artificial butterflies, the developers benefited from the knowledge gained with the projects involving the BionicOpter and the eMotionSpheres. The indoor GPS that was already used for the hovering spheres was further developed for the eMotionButterflies with regard to the image rate of the cameras.

In close cooperation with the University of Oslo, Festo is now presenting the FlexShapeGripper with a working principle derived from the chameleon's tongue.

The FlexShapeGripper can grip, collect and release several objects of different shapes in one process without the need for manual conversion. This is made possible by its water-filled silicone cap, which wraps itself around the items being gripped in a flexible, form-fitting manner. This ability to adapt to different shapes gives the FlexShapeGripper its name. The holding and release mechanisms both operate pneumatically. No additional energy is required for the holding process. The yielding nature of compressible air facilitates the coordination of the handling and the gripper during the grasping process.

The FlexShapeGripper is designed for situations where differently shaped objects are to be handled simultaneously; for example, in service robotics, in assembly tasks, or in the handling of small components. The bionic model demonstrates approaches for new solutions in gripping technology with the help of pack-and-place processes and makes manufacturing units more flexible and adaptable.

### For more information:

Festo Corporation  
[www.festo.us](http://www.festo.us)

# THOTH



## Quality Achievement Dream

Ningbo Zhongyi Hydraulic Motor Co, Ltd was found in 1971, which is the high tech mfg. expert of orbital motors, steering control units, transmission and mobile motors. At present we have two manufacturing bases, one is in Ningbo city covering an area of 44,000 square meters, the other one is in Wuhu city with an area of 80,000 square meters. Our manufacturing workshop meets the international standards and the manufacture and test equipments are leading technologically home and abroad. The staffs of Zhongyi will create first class products, services and brand hands in hands with you.

For more information, pls visit [www.zihyd.com](http://www.zihyd.com) .

Email: [sales@zihyd.com](mailto:sales@zihyd.com) or [Linda@zihyd.com](mailto:Linda@zihyd.com)

Tel:0086-574-86378895 Fax:0086-574-86378310



# JVL Hollow Core Rotary Actuators

AVAILABLE WITH MIS231 INTEGRATED STEPPER OR SERVO MOTOR

JVL recently introduced six hollow core rotary actuators. These integrated rotary actuators are available in two table sizes: the HDCT-100 and the HDCT-130, and each with a choice of three motors. An optional sensor kit, and control modules such as Profibus, Devicenet and Ethernet, and point-and-click programming are designed

to allow for easy integration into new and existing applications.

Each of the hollow core rotary actuators is available either with the MIS231 integrated stepper or with an integrated servo motor, the MAC140 or MAC400. The table diameter and hollow core of the HDCT-100 is 95 mm (3.74 in.) and 29 mm (1.14 in.) and the table diam-

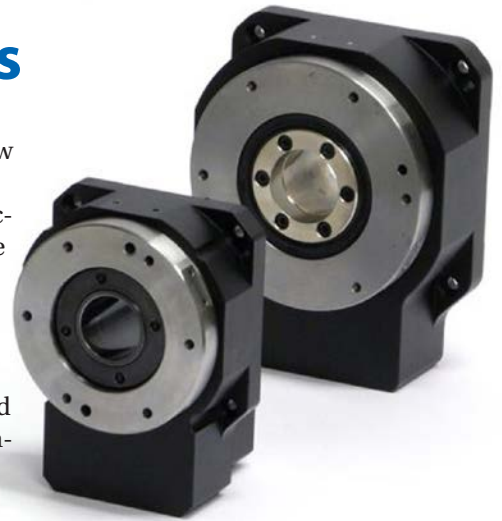

eter and hollow core of the HDCT-130 are 120 mm (4.72 in.) and 35 mm (1.38 in.). Mounted in any position, these rotary actuators are designed for manufacturing, inspection, positioning, research, tracking, medical, and other applications.

The HDCT-100 has a nominal output torque of 6.8Nm (963 oz-in.), max speed of 167 or 200 RPM (motor dependent), and axial load of 150N (33.7 lbs.). The HDCT-130 has a nominal output torque of 12Nm (1699 oz-in.), max speed of 167 or 200 RPM (motor dependent), and axial load of 200N (45 lbs.). Each of these low cost, precision hollow rotary actuators has repetitive positioning accuracy of  $\pm 15$  arcsec, runout of table surface  $\pm 0.015$  mm (.00059 in.), and parallelism of platform  $\pm 0.03$  mm (.001 in.).

**For more information:**

Phone: +45 4582-4440  
[www.jvlusa.com](http://www.jvlusa.com)



[www.circlegear.com](http://www.circlegear.com)

**Circle Gear and Machine**

1501 South 55th Ct. • Cicero, IL 60804  
 Ph: 708-652-1000 • Fax: 708-652-1100

**WE'VE EXPANDED!**

**EQUIPMENT PURCHASES**

- Luren LFG-8040 Verticle Gear Profile Grinder
- Gleason 463 spiral/hypoid gear tooth grinder

**FACILITY**

- Purchased 77,000 sq ft building, expanding to 122,000 sq ft

**STRATEGIC PLANS**

- Continued growth in spiral bevel/hypoid marketplace
- Expand gearbox service and overhaul business

**GEARBOX REPAIR SPECIALISTS**

- Prompt, accurate quotations
- Competitive pricing
- Quality repairs/rebuilds

**Quality Reducer Service**

1501 South 55th Ct. ■ Cicero, IL 60804  
 708-354-8080 | FAX: 708-652-1133



WE SERVICE ALL TYPES OF INDUSTRIAL GEARBOXES

[www.qualityreducer.com](http://www.qualityreducer.com)

**YOU'RE IN IT TO WIN.**

**WE'RE HERE TO  
MAKE SURE  
YOU DO.**

**You're driven,  
determined,  
focused on  
your business.  
And so are we.**

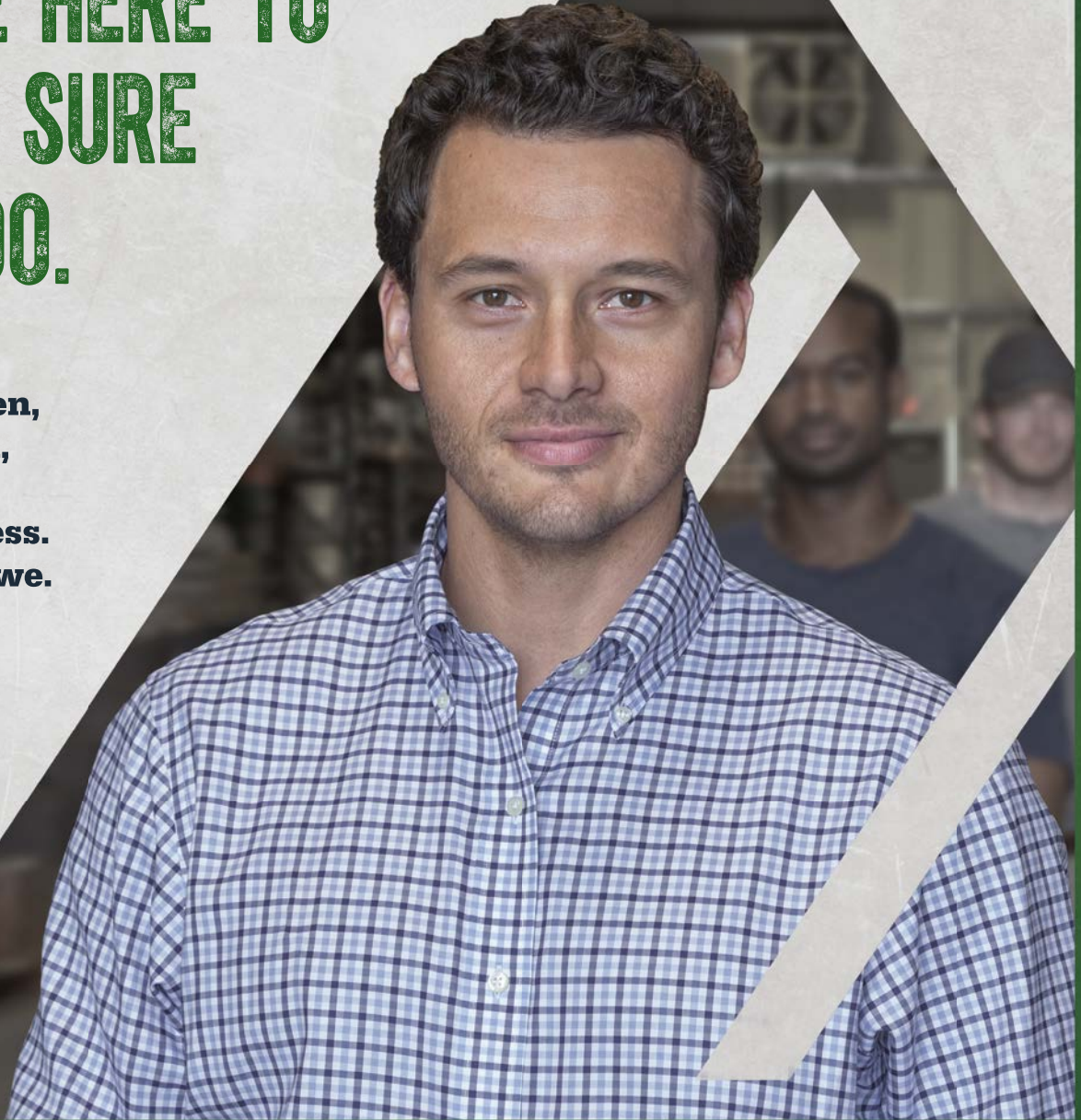

As a community of growth-oriented distributors and suppliers, we prove time and again that as strong as we each are alone, together we are even stronger.

Join us at [adhq.com/win](http://adhq.com/win).



**AD**

Together, we win.

# DieQua offers more gearboxes

plus the experience and expertise to select the best one for your needs.

## For Power Transmission

### Spiral Bevel Gearboxes



- 9 Sizes
- 1-250 HP Capacity
- Low Backlash Option
- Ratios from 1:1 to 6:1
- Output Shaft Options
- Machined Housings

### Worm Reducers



- 7 sizes, 28-110mm CD
- Fret-free Connection
- NEMA or IEC Adapters
- Coupling Input
- Aluminum Housings
- 2-Side Worm Support

### Helical Gearmotors



- 1-75 HP Capacity
- Motorized or Adapters
- Right Angle or Inline
- Shaft Mount Designs
- Multi-Stage Ratios
- Modular Design

## For Motion Control

### Planetary Gearheads



- Precision or Economy
- Inline or Right Angle
- 40-155mm Frames
- Low Backlash
- 1 and 2 Stage Ratios
- Lubricated for Life

### Servo Worm Gearheads



- 3 Backlash Levels
- Shafts or Hollow Bores
- Single or Dual Outputs
- 11 sizes, 25-200mm CD
- Capacity: 10-7000 Nm
- 20,000 Hour Ratings

### Robot Gear Units



- Zero Backlash
- Precise Positioning
- High Repeatability
- High Stiffness
- Supports Tilting
- 10 Sizes

See our complete product line!

**DIEQUA**  
Corporation  
www.diequa.com  
630-980-1133



# SKF Spindle Assessment Kit

DETECTS SPINDLE UNBALANCE CONDITIONS

The SKF Spindle Assessment Kit provides an easy way to measure and interpret key spindle operating data to help users detect developing problems before they can escalate. Designed for use after a spindle is assembled and installed in a machine tool, the kit can help OEMs or quality control staff to validate performance indicators, including vibration, thermal behavior, running accuracy, and natural frequency, among others. The kit also can detect spindle unbalance conditions and assist in understanding resonance frequency, which is essential to cutting quality. The kit delivers cost-effective condition monitoring technology to help avoid spindle downtime and increase machine tool uptime.

The SKF Spindle Assessment Kit includes three programs: spindle test module, balancing module (for fine tuning) and RUCD (Run Up Coast Down) module (to test resonance frequency). The spindle test module provides nine condition tests: imbalance and balancing (vibration), bearing condition (vibration), mechanical condition (vibration), resonance frequency, speed accuracy, belt tension, tool nose run out, EM distance and clamp force.



The complete kit consists of a portable SKF Microlog Analyzer, acceleration sensor, laser tachometer, dial gauge with gauge stand, belt tension gauge, and a spindle-specific software package preconfigured to convert measured data into intuitive green-amber-red (“traffic light”) color-coded results.

The kit provides step-by-step instructions and features lightweight ergonomic design, extended battery life, easy operation function keys, and rugged and water-resistant design. Automatic analysis of spindle condition will indicate possible faults, imbalance, and bearing defects, among other operating problems.

### For more information:

Phone: (267) 436-6723  
www.skfusa.com

# Rexroth EMC HD Electromechanical Cylinders

OFFER SUPERIOR HEAVY LOAD CONTROL

Rexroth recently introduced the EMC Heavy Duty (HD) electromechanical cylinders, designed to make the benefits of advanced control technology available, even at high forces. The ready-to-install units are suitable for machinery and equipment as well as for outdoor use. Users can integrate them for intelligent energy management, thus reducing power consumption and CO2 emissions.

Force, position and speed are designed to be parameterized by the

user and adapted at all times to new tasks via the drive system. Without an additional position sensor, the EMC-HD achieves a repeatability accuracy of up to  $\pm 0.01$  mm, and they do so for any number of selectable positions within the travel range of up to 1,200 mm. The electromechanical cylinders for heavy loads are driven either by ball or planetary screw assemblies, depending on the





# Boston Gear 700 Series Speed Reducers

DESIGNED FOR CORROSION RESISTANCE

Catalogued models of Boston Gear's stainless steel 700 Series speed reducers are now available with standard two-day delivery.

Boston Gear's SS700 Series, the original "domed crown" stainless steel reducers, are designed for corrosion resistance and high-pressure food processing and packaging washdown applications.

All SS700 models are NSF Certified and have maintenance features including electropolished exterior finish, sealed motor flange, and covered hardware. To prevent miniscule niches that can host microbial contamination, the nameplate has been laser marked to provide a smooth uninterrupted surface. An internal oil reservoir, filled with H1 food-grade lubricant (Klbersynth UH 1 6-460) and sealed for life, allows for use under a range of operating temperatures and extended service life.

## For more information:

Phone: (704) 588-5610  
[www.bostongearss700.com](http://www.bostongearss700.com)



dynamic and power requirements. The high-precision, backlash-free preloaded Rexroth screw assemblies are offered in various sizes and leads economically cover a wide range of application demands. Rexroth offers the EMC-HD both as finished, purely mechanical axes as well as a complete system with precisely matched gears, servo motors and controllers from the IndraDrive product line.

For the installation of the heavy-duty cylinders, the user can choose from



American Gear Manufacturers Association



## RAVE GEARS & MACHINING

TALENT & TECHNOLOGY DRIVEN



THE DRIVE TECHNOLOGY SHOW™  
Booth # 1339

**WE ARE READY TO MEET YOUR NEEDS**





**OUR BRAND-NEW, STATE-OF-THE-ART FACILITY IS PRODUCING THE HIGHEST QUALITY SPIRAL BEVEL, HYPOID, SPUR, AND HELICAL GEARS.**

- Latest Equipment
- AS9100 Certified
- Fast Delivery

- Talented Employees
- ISO 9001-2008 Certified
- Design & Engineering

**CURRENT** customers in aerospace, racing, oil & other industries.





425 Stempel St. Seguin, TX 78155 | (855) RAV GEAR  
[www.RAVEGEARS.com](http://www.RAVEGEARS.com) | [sales@ravegears.com](mailto:sales@ravegears.com)



**Established,  
Tested,  
& Trusted.**



**Using technology & innovation to meet your needs – now and into the future.**

**Brevini Gear:**

Offers innovative solutions to complex geartrain challenges with state-of-the-art technologies in engineering, manufacturing and validation.

Focuses only on large, high-precision gears and gear related components.

Commits to meeting your technical, quality and delivery requirements for R&D, quality assurance, serial production or remanufacturing at a competitive price.

**The Brevini Advantage**

- AGMA Quality Level: 2015-1-A01 Grade 3
- Helical and spur gear capability: 12" (305 mm) to 68.10" (1730 mm)
- Helical and spur ring gear capability: 24" (600 mm) to 94.49" (2400 mm) OD
- In-house deep case, carburizing
- Design, assembly, and gear/gearbox validation

**Brevini Gear**

2400 N. Priority Way  
Yorktown, IN 47396  
765-759-2128  
info@brevinigeared.com

**brevinigeared.com**



numerous mounting options reducing the construction and assembly work involved. The electromechanical solution does not require any additional components and incorporates space-saving machine designs.

Rexroth IndraDrive electromechanical servo drives offer numerous opportunities for intelligent energy management. The drives can regain and store braking energy.

The EMC-HD with IP65 protection

class is also suitable for outdoor use and operates reliably over a wide temperature range. The construction is designed to ensure a long lifespan, even under harsh environmental conditions. The sealing system protects the cylinder from wear resulting from exterior contamination.

**For more information:**

Phone: (717) 393-3831  
[www.boschrexroth.com](http://www.boschrexroth.com)

**Nexen Group Versa Rack**

AN ALTERNATIVE TO TRADITIONAL METAL RACKS

Nexen Group, Inc. recently introduced the Versa thermoplastic rack — an alternative to traditional metal racks that are designed to deliver high-corrosion resistance and durability, low maintenance requirements and medium accuracy and load-carrying capacity at a relatively low cost point. The Versa Rack is made for applications such as CNC routers and conveyers, as well as many picking, part-marking and gantry-based automation systems.

Made of self-lubricating polymer, the Versa Rack is able to run at full speed without additional lubrication. It can withstand washdown, outdoors operation (even in coastal climates with salty air) and other challenges, making it an option for usage in dirty environments,

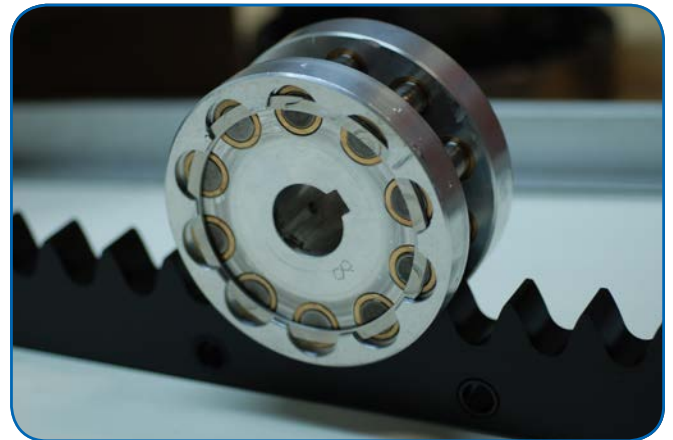

clean rooms and food/pharmaceutical production.

The Versa Rack features backlash less than 3.2 um and positional accuracy of ± 580 um, depending on the pinion selected. It can be used with any of Nexen's pinions — either its value pinion or its higher performance premium pinions. The Versa Rack withstands loads of 500 to 1200 Newtons depending on pinion size. The speed rating of value pinions and thermoplastic racks is 480 to 750 RPM and 2 m/s.

**For more information:**

Phone: (800) 843-7445  
[www.nexengroup.com](http://www.nexengroup.com)



# RSF Elektronik MSA 37x Feedback Encoder System

DESIGNED FOR MOTION APPLICATIONS

RSF Elektronik now offers a linear motion feedback encoder system that is designed for machines with loose mechanical motion during operation. Called the MSA 37x series, these encoders are designed for motion applications such as press brake and metal forming/bending machines, or any other type of machine that have significant flexure near the area requiring motion feedback.



Available in North America through Heidenhain Corporation, the MSA 37x series has a design that includes a bearing set internally for guiding the scanning optics, and a bearing set externally for the attachment of a cou-

pling rod that affixes to the machine, thereby allowing for measurement of the moving elements of the machine.

**For more information:**

Phone: (847) 490-0387  
[www.rsf.at](http://www.rsf.at)

# Maxon EC 4 Brushless DC Motor

MEASURES JUST 4 MM IN DIAMETER

The EC 4 brushless DC motor is Maxon Motor's ultra-compact motor. As the smallest micromotor to come from them, the EC 4 is only 4 mm in diameter. It is available in two lengths, with power ratings of 0.5 and 1 W. Equipped with an ironless Maxon winding, the EC 4 has a robust design and high power density.

Combined with the matching GP 4 planetary gearhead, the EC 4 becomes a compact drive for use in micropumps, analytic and diagnostic devices, and laboratory robots. It can adjust lenses, dispense fluids, or position sensing devices. All units meet the ISO 13485 medical standard.

**For more information:**

Phone: (508) 677-0520  
[www.maxonmotorusa.com](http://www.maxonmotorusa.com)

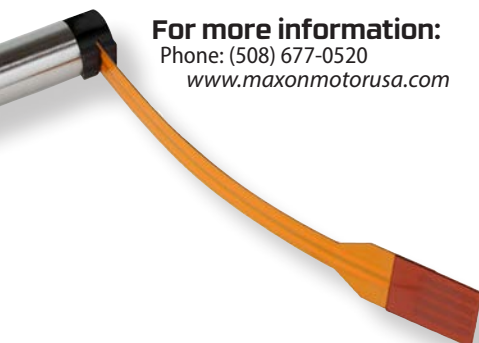

# The Full Spectrum

Gear solutions made easy with one of the most comprehensive and versatile gear reduction lines in the Metric market. With over 45 years of proven performance, Lafert's power transmission products will let you push through even in the most demanding applications.

Right Angle Worm Gearboxes

Helical Inline Gear Reduction

Bevel Helical Gearboxes

Mechanical Speed Variators

Parallel Shaft Gearboxes

Shaft Mounted Gearboxes

Right Angle Worm Gearboxes

Bevel Gearboxes

Combination Right Angle Worm Gearboxes

Double Wormwheel Gearboxes

Shaft Mounted Helical Gearboxes

Planetary Gearboxes



**LAFERT**  
NORTHAMERICA

Toll Free: 1.800.661.6413 | Fax: 1.905.629.2852  
[www.lafertna.com](http://www.lafertna.com) | [sales@lafertna.com](mailto:sales@lafertna.com)

**SITI**  
S.P.A.  
SOCIETA' ITALIANA TRASPARENTE E QUOTATA IN BORSA

Copyright Lafert North America 2013. All rights reserved.

# Ringfeder Tschan TNR Elastic Couplings

OPTIMIZE TORSIONAL VIBRATION DURING OPERATION

Ringfeder Power Transmission recently introduced the Tschan TNR, a new model for highly elastic couplings. Unlike commonly used torsionally elastic shaft couplings, the TNR is adjustable and therefore allows for a smoother start-up of power transmissions. It also optimizes torsional vibration during operation. If it is mounted between the combustion engine and the trans-

fer box, for example, this novel, non-shiftable coupling is not just suited for mobile construction machines such as excavators, cranes and wheel loaders, but also for power generation wherever combustion engines such as emergency power units or mobile generators are used.

When internal combustion engines are employed, as is frequently the case

with Diesel engines, the power train is subject to dynamic stimuli. These manifest in torsional-vibration behavior and are caused periodically as gas and mass forces are excited. The actual dynamic behavior of the power train can be plotted mathematically by joining mass moments of inertia, damping and rigidity. It is, however, the stiffness and the mass moments of inertia of the entire power train that determine at which frequencies, i.e. rotations, the disruptions occur. The position of the lowest natural frequency is defined by the distribution of the mass moments of inertia of the rotating components and the smallest rigidity. When the excitation frequency and the natural frequency coincide, resonance is inevitable. By adjusting the mass moments of inertia and the rigidity of the coupling, both can be moved from service speed into the non-critical range.

An example of the aforementioned behavior is the flywheel in diesel engines. Since the dimensions of flywheels are made with the fuel consumption and operating characteristics in mind, i.e. they are designed for the combustion process, it would be unwise to try to do anything at the vibration points on the drive side by using an additional mass moment of inertia. In practice, elastic couplings with a relatively low stiffness have stood their ground as the “problem solvers”.

This is where the new Tschan TNR comes in. Due to its low stiffness, the shaft coupling influences the above-mentioned vibration points the most. The key figures of the coupling can now be adjusted on a larger scale and with little effort, while the out dimensions remain the same. The coupling becomes “adjustable” because the elastic buffers are separated one from another and, as a result, are ordered in series. This requires a smart combination of available elastomers on one inner and one outer buffer plane.

**For more information:**

Phone: +49 (0)6078-9385-0  
[www.ringfeder.com](http://www.ringfeder.com)

## HOW DO I KNOW IF I'M TALKING TO AN ENGINEER OR A SALESMAN?

**Ask Smalley.** It's simple to tell when you work with Smalley. That's because you'll always collaborate directly with our world-class team of engineers—experts whose only focus is helping you get the most performance from your precision wave springs or retaining rings.

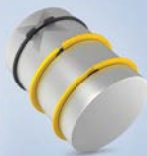

Smalley retaining rings eliminate the protruding ears that interfere with assemblies, while providing a 360-degree retaining surface. And their unique design means no special tools are required.

Visit [smalley.com](http://smalley.com) for your no-charge test samples.



THE ENGINEER'S CHOICE™

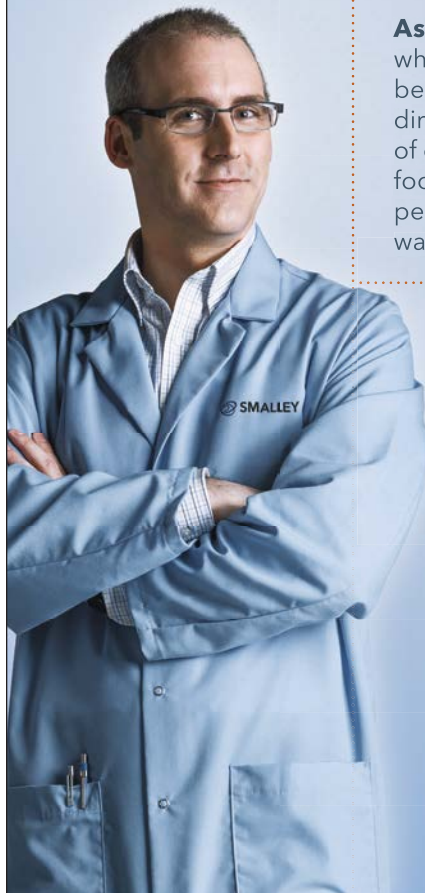



**GEAREXPO**  
2015  
THE DRIVE TECHNOLOGY SHOW

# POWERFUL CONNECTIONS

OCTOBER 20-22, 2015  
DETROIT, MI  
COBO CENTER

**REGISTER TODAY**  
FOR **THE DRIVE TECHNOLOGY SHOW** OF THE YEAR!

**GEAR EXPO 2015** brings together the full range of experts — design, manufacturing, application engineering — all in the same place — **Cobo Center, Detroit, October 20-22.**

From a single gear to complex drives, **GEAR EXPO** covers it all...

- **More exhibitors** — from gear making machines to systems integrators.
- **More education sessions** — from metallurgy and geometry to maximizing power density.
- **More attendees** — buyers and makers from automotive, construction, mining, agriculture — wherever high-performance drives are critical.
- **More solutions** — meet the experts and evaluate your capabilities.

**GEAR EXPO 2015 is the place to be.**

- Make powerful connections.
- See the latest technology in action.
- Get the inspiration you need to take your products to the next level.

Improved drive technology is critical to achieving higher efficiencies and longer service life. All the information and answers you need will be at **GEAR EXPO 2015.**

**VISIT**

[www.gearexpo.com/GEPOWER](http://www.gearexpo.com/GEPOWER)

Use code **GEPOWER** when registering.

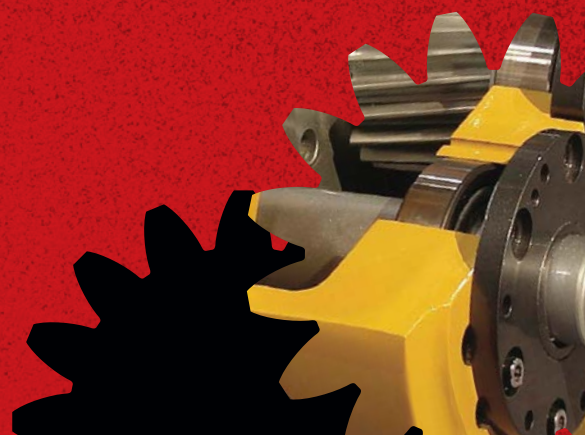

# Braking the Cycle

## Oak Crest Lumber's Switch to Oil Shear Clutch-Brakes Yields Years of Trouble-Free Service

Tucked away in the south-west quadrant of the state of Georgia, amid stately pine stands, pecan farms and cotton fields, sits Oak Crest Lumber. While the scenery may be bucolic, the pace within this lumberyard is anything but serene, as the facility surfaces 45,000 board feet of lumber daily. Maintaining that pace of production means that all of the company's equipment must be working. When the dry magnetic clutch-brake on their tilt-hoist began to wear out frequently (it needed to be replaced each six months or so), Oak Crest officials knew it was time for a change. They installed an oil shear clutch-brake, and it has been working steadily for the past four years.

Surfacing is the next to last step before the boards are bundled and tallied for shipment. Prior to being fed into the planer machine, lumber packs are placed into the tilt-hoist. Its lift arms incline and index every inch and a half, thus feeding the  $1\frac{3}{16}$ " thick boards to the surfacing line. The tilt-hoist works all day long, 42 layers per pack, processing 20 or more packs per day.

While the current oil shear clutch-brake is up to the challenges of this demanding application, the dry, magnetic, friction-type clutch-brake that was previously installed was not. Plant technician Johnnie Thomas Jr. recalls that when the machinery was first installed, the dry clutch-brake performed well, lasting five years or so. But once the replacements started, they kept coming.

"We had to replace clutch-brakes every 6-8 months," Thomas says.



One of the key machines in the Oak Crest manufacturing facility is the tilt-hoist that positions the lumber for final surfacing.

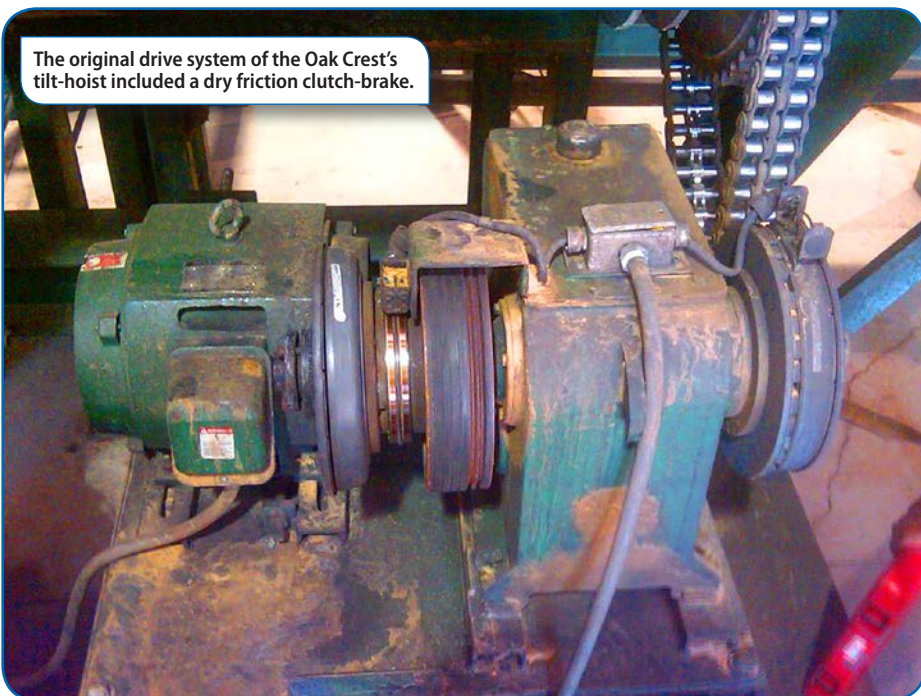

The original drive system of the Oak Crest's tilt-hoist included a dry friction clutch-brake.

To complicate matters, the clutch-brake virtually always failed while processing a pack of lumber.

“The clutch-brake always seemed to fail in the up position,” Thomas says. This was problematic for several reasons. “Once you break the magnet away from the clutch-plate, the whole load would come crashing down.”

Naturally, this is a safety concern, so the lumber pack had to be removed by hand, which was painstakingly slow and labor-intensive.

“We’d have to unload the lumber, then take a come-along to take the clutch off and let the bed down easy,” Thomas says.

With the lumber removed, the magnet broken free from the clutch-plate, and the tilt arms returned to the floor, the process still required several hours to complete. Oak Crest would keep a spare clutch-brake in stock to speed the process, which ultimately took the better part of a day from failure to re-start.

The raw cost of the clutch-brake — purchased in two pieces, the magnet and the clutch-plate — was around \$1,800 (up from \$1,200 on their original replacement order). Depending upon the market price of lumber, downtime is figured at between \$700 and \$800 per hour. So if the tilt-hoist clutch-brake failed while loaded with a pack of lumber in the up position, an 8-hour replacement could easily cost \$7,500 (including downtime and parts cost).

Thomas recalled lamenting to his local motor shop, Nelson Electric, about the situation. They suggested looking at the Force Control oil shear clutch-brake product. Jim McHugh, Force Control’s Southeast regional manager visited soon thereafter and determined that a size 5 fan-cooled Posidyne model SA clutch-brake would be sufficient. The initial cost of the oil shear clutch-brake, at \$6,500, was higher than the dry clutch-brake model it was replacing. However, the prospect for longer service life would more than make up the difference, he hoped. This is especially true considering that with a fully loaded tilt hoist, the plant might be looking at \$6,400 in downtime alone,

plus replacement clutch-brake costs.

Now, four-plus years later, that same oil shear clutch-brake is still in operation. “We put in the Force Control brake and haven’t had a problem with it since,” Thomas says.

Assuming an eight-month service life, Oak Crest would have gone through six of the old style clutch-brakes in this same time period — at a cost of \$10,800 for parts only (does not

include labor to install or downtime).

“I’ve been here for 25 years, and we’ve bought a lot of equipment in that time,” Thomas says. “This might be the best equipment investment that we’ve made.”

### How Oil Shear Technology Works

Normal dry clutches employ a sacrificial surface — a disc or pad — to en-

**IDC SELECT** | Value You Can Depend On

Available at hundreds of independent distributor locations

You need **quality products**, at the **right price**, **right now**. Our full range of precision bearings is available at hundreds of authorized independent distributor locations nationwide.

Don't lose time and money waiting. Find a location near you at [IDCselect.com](http://IDCselect.com).

	<b>Bearings</b>		<b>Belts</b>
	<b>Bushings</b>		<b>Chain</b>
	<b>Idlers &amp; Tensioners</b>		<b>Hose</b>
	<b>Shafting</b>		<b>Jaw Couplings</b>
	<b>Sprockets</b>		<b>Sheaves</b>

 [IDCselect.com](http://IDCselect.com)

gage the load. Having no good way to remove the heat caused from engagement between the disk and plate, this material must absorb the heat. These extremely high temperatures will eventually degrade the friction material. As the friction surface wears away and begins to glaze, the spring force is reduced, causing ensuing torque fade. This causes positioning errors, which

require adjustment or replacement of the friction surface.

Oil-shear technology plays a major role in ensuring that the planer tilt-hoist at Oak Crest Lumber can operate day-in and day-out. Since a fluid film flows between the friction surfaces, the fluid is compressed as the clutch is engaged. The automatic transmission fluid in shear transmits torque. This torque transmission causes the sta-

tionary surface to turn, bringing it up to the same relative speed as the moving surface. Since most of the work is done by the fluid particles in shear, by the time the surfaces actually meet or “lock up,” wear is virtually eliminated.

In addition to transmitting torque, the fluid also helps to dissipate heat, due to a patented fluid recirculation system. Along with torque transmission and heat removal, the fluid also serves to continually lubricate all components, thus extending service life. Oil shear technology also provides a “cushioned” engagement that reduces shock to the drive system, further extending service life. Unlike dry clutches, the totally enclosed oil shear system is impervious to external elements such as wet, dusty or dirty environments. Since the layer of oil eliminates wear, the oil shear clutch provides a long service life. With the elimination of wear comes the elimination of adjustment—and increased “uptime” for the surfacing operation.

As Oak Crest Lumber has grown, Thomas has purchased a lot of equipment to help fuel that growth. Sometimes the equipment is notorious for its repair history and need for frequent



# THE PROTECTOR

FOR THE SAFETY OF YOUR DRIVE LINE:  
OUR PRELOADED BALL-DETENT SAFETY COUPLINGS.

RW-AMERICA.COM

THE COUPLING.



The old-style clutch-brake used a friction element to create the necessary stopping force.





replacement. But the oil shear clutch-brake purchased for the Salem planer-tilt-hoist is memorable because it requires virtually no maintenance or adjustment. That leaves more time for Thomas and his crew to focus on other aspects of the business — like continuing to fix the next weakest link in the production chain, so that they can continue their growth. **PTE**

**For more information:**

Force Control Industries  
 3660 Dixie Highway  
 Fairfield, OH 45014  
 Phone: (513) 868-0900  
 Fax: (513) 868-2105  
[www.forcecontrol.com](http://www.forcecontrol.com)



For Related Articles Search



clutches



at [www.powertransmission.com](http://www.powertransmission.com)

**McINNES**  
 ROLLED RINGS

**EXPECT MORE**

  
 Fast Quoting

  
  
 Exceptional Product Quality

  
  
 On-Time Delivery



**"I'll get your quote within 4 hours."**

*Brandy - Inside Sales Associate*

Our team is committed to keeping our promises and ensuring your complete satisfaction from inquiry to delivery.

Learn more at [McInnesRolledRings.com/ExpectMore](http://McInnesRolledRings.com/ExpectMore)

**1.800.569.1420**

# The Race for Efficiency

**Today's high-efficiency motor market is racing ahead of legislation — and the rest of us need to catch up.**

Alex Cannella, News Editor

Over the past few decades, energy efficiency in motors has become an ever-increasing concern for OEMs and manufacturers alike. With multiple energy bills mandating higher efficiency across ever-broader spectrums of motors, including the most recent Small Motor Rule by the Department of Energy, efficiency has become an essential consideration when choosing a new motor.

But industry is outpacing legislation. While recent mandates have expanded the range of motors that must meet IE3 efficiency standards (or, as we call them in America, premium motors), they haven't upped the efficiency rating itself. Motor manufacturers, meanwhile, have continued to push the standard, creating IE4 and even IE5 models, the latter of which haven't even been officially defined, much less regulated. Even without a legislative push, the race to produce increasingly impressive "super-premium" motors has only gotten more intense.

"It's more competition," Dan Jones, president of Incremotion Associates, said. "[It's] 'I've got a better motor than yours.'"

At first glance, the decision to push beyond the mandated IE3s could be considered a dubious one. End users aren't currently required to replace old and inefficient motors — they just have to upgrade if they get a new one, and companies aren't under any mandatory compulsion to go super-premium like they are to pick up an IE3. Businesses looking to squeak by with the bare minimum will likely choose IE3 motors, which could last 15 years on average. That leaves a fairly small market for more advanced motors.

Compounding the issue is that, as efficiency goes up, so do the costs of development. Pushing a motor from the IE3 to the IE4 category requires a

significant spike in cost compared to going from IE2 to 3. Normally, in order to improve the efficiency of a motor, manufacturers just add a little copper and iron, but that method doesn't quite cut it to reach IE4. The two ways manufacturers have found of pushing a motor's efficiency to IE4 levels is to either use a rotor entirely made of copper or to utilize permanent magnets. Either option is vastly more expensive than the typical aluminum cast motor. And as the cost of production exponentially rises, the margin of improvement between each tier of motors goes down.

Faced with these difficulties, end users and manufacturers alike aren't all onboard with the push for greater efficiency. Super-premium efficiency motors are still considered a niche market (though they are a rapidly growing one), some businesses are opting to get around regulations by rewinding old IE2 motors instead of buying more efficient IE3s, much less forking over the extra cash to get an IE4, and according to Jones, many of America's own manufacturers aren't interested in producing IE4s.

"We have led in efficiency in induction motors since the beginning," Jones said. "We're going to give up the lead to the Europeans in the next three years. Because they want to go higher."

Jones believes that European manufacturers are spearheading the super-premium charge due to a difference of mindset in their customer base compared to America's.

"In America, the first three most important things we have are cost, cost, and cost," Jones said. "Because they expect you'll make performance. So the emphasis always switches to cost. Europeans are willing to pay up more [for quality]."

But according to Jones, many end

users and manufacturers alike aren't necessarily looking at the full picture. Many companies are looking at the rising costs of super-premium efficiency motors for decreasing returns and drawing a line at regular premium, but look a little past the surface, and the push for super-premium motors starts to make sense.

"[In Europe] they looked at the lost watts in the motor, and they said 'We're going to go down at least 15%, so for the larger motors, we'll make the motor maybe only half a percent more efficient,'" Jones said. "That doesn't sound like a lot, but you look over a year at all the times it's running, and you end up with thousands of dollars saved. You get fooled by looking at the law of diminishing returns. As we make the efficiency higher and higher, the percentage improvement goes down, but you have to look at it on the basis of how many kilowatts are lost."

In actuality, it's not only worth it for many end users to consider purchasing an IE4 motor over an IE3 or repairing an older model, it may even be recommended. According to a guidebook put out by the CEE in 2013, the upfront cost to buy and install a motor only accounts for 3-5 percent of the motor's lifetime expenses. The CEE has found that over the course of a decade, electricity bills make up 95 percent of a motor's operational costs. After picking up a motor, businesses are still paying 19 times their initial investment in electrical bills over the following decade. Just like IE3 motors, IE4s pay themselves off in only a few years' time, and while the margin of energy savings may not be as great as going from a standard efficiency (IE2) motor to an IE3, the fact remains that going to an IE4 still provides savings over a lifetime of service.

As awareness of super-premium motors grows, so too does the industry.

For Related Articles Search

motor efficiency

at [www.powertransmission.com](http://www.powertransmission.com)

The market has experienced double digit growth rates since 2009. But while IE4 and better motors are gaining significant traction, they still only make up a fraction of global motor sales. They aren't catching on quite as much they could or, perhaps, should. According to Jones, the reason may be as simple as a lack of communication.

"The guy that pays the electric bill is not the guy that buys the motor," Jones said. "In any company."

And if those two aren't communicating, the potential energy savings may go unnoticed. If the savings go unnoticed, then the "guy buying the motor" can only look at the cost of an IE4 vs. an IE3 or repairs.

The super-premium market's growing figures, however, would suggest that awareness is building, and the future of the industry looks bright. Super-premium is catching on, and all that's left is for the rest of us to catch up.

But in the meantime, manufacturers will continue to race ahead and produce the future of motors. **PTE**

### Want to Calculate Your Savings?

On the fence about whether to repair your old motor or buy a new, more efficient one? The Office of Energy Efficiency and Renewable Energy (OEERE) has developed a program to calculate your potential savings and whether or not you should upgrade to a more efficient motor. MotorMaster+ International has a database consisting of thousands of different motor designs complete with performance information and listed prices. For more information and a free download, go to [www.energy.gov/eere/amo/articles/motor-master-international](http://www.energy.gov/eere/amo/articles/motor-master-international).

# Power Transmission Engineering online!

It's like your own professional superpower.

Stronger, faster and smarter than your average website, [www.powertransmission.com](http://www.powertransmission.com) offers everything you need to supercharge your engineering-oriented organization.

- Complete archive of articles on engineered components
- Directory of suppliers of gears, bearings, motors and other mechanical power transmission components
- Product and Industry News updated daily
- Exclusive online content in our e-mail newsletters
- The Bearings Blog
- Calendar of upcoming events
- Comprehensive search feature helps you find what you're looking for — *faster than a speeding bullet!*



[www.powertransmission.com](http://www.powertransmission.com)

## Clutches • Brakes • Torque Limiters

### Made To Order

- Custom, precision-crafted design solutions
- Bored and keyed to fit specific shaft sizes
- Superior durability, low maintenance
- Reliable ship dates



U.S. Toll Free: 866-291-0849  
International: 859-291-0849  
[www.machiii.com](http://www.machiii.com)



Copyright ©2015, Mach III Clutch, Inc. All rights reserved.

# Are You Not Entertained?

Pack Expo Las Vegas promises to be insightful and educational – and fun, too

Erik Schmidt, Assistant Editor

Like Moses descending from Mount Sinai toting a couple of stone tablets, Kate Achelpohl, director of member communications at PMMI and herald of all things Pack Expo, came hither proclaiming the four commandments of the forthcoming show:

*Insights. Innovation. Interaction. Inspiration.*

It was all very prophetic. Interestingly, the Pack Expo website actually lists five cardinal virtues. The final one was an odd omission in Achelpohl's royal decree, like a dirty little secret being swept under the rug. But there, at the bottom of the official site's "Why Attend" page, you can see the forbidden factoid in full bloom:

*Entertainment.*

OK, maybe we get it. On the hierarchy of a trade show's intrinsic worth, having a grand old time probably does fall slightly behind those other four noble merits. But—and this is a big "but"—Pack Expo (co-located with

Pharma Expo) takes place in Las Vegas, baby. You know, Sin City? — Neon signs, flashing lights, green felt tables, the Midnight Idol himself Wayne Newton, et cetera ad nauseam.

And right there in the middle of it all is Pack Expo.

So even though Achelpohl excluded "entertainment" in her marketing magna carta, trying to ignore its hovering, iridescent presence is like standing under the Fountains of Bellagio and trying to stay dry. We dare you not to be entertained while you're there.

In fact, emboldened by the spirit of Las Vegas, we bet that you will be.

## Let the Cross-Pollination Begin

It should be noted first off that Pack Expo Las Vegas (Sept. 28-30) wasn't the first show put on by PMMI. Nor will it be the last (through February of 2017, PMMI will actually host five more global events).

But compared to the other shows' locations—Chicago, Philadelphia and

Mexico, all stellar venues in their own right, of course—this Pack Expo certainly shines the brightest, both literally and metaphorically.

"The growth of Pack Expo has been notable throughout its 59-year history," Achelpohl says. "Since PMMI introduced Pack Expo in 1956, it has evolved from a single show with 136 exhibitors, 5,000 attendees and 43,116 net square feet of exhibit space into a portfolio with more than seven shows in the United States and Mexico.

"In 1995, PMMI introduced the industry to Pack Expo Las Vegas (then known as Pack Expo West) featuring packaging equipment from 532 exhibitors and attracting 9,334 attendees. Exhibit space was about 200,000 net square feet—about a quarter of the size of this year's event. As the show has evolved, it has become an event that unites the processing and packaging supply chain, and where attendees can address a wide range of projects.

"This year, Pharma Expo makes its Las Vegas debut as a co-located event.

All photos courtesy of The Association for Packaging & Processing Technologies





# PACK EXPO Las Vegas September 28 – 30, 2015 Las Vegas, Nevada USA

ADVANCING PROCESSING & PACKAGING

Together, Pack Expo Las Vegas and Pharma Expo will draw more than 2,000 exhibitors and 30,000 attendees to more than 800,000 net square feet of exhibit space. With the co-location, there's a new level of opportunity to 'cross-pollinate' your thinking and draw inspiration from applications from outside your industry."

The show brings together a mass conglomeration of different industries, including beverage, branding, confectionary, dairy, food, personal care, packaging, pharmaceutical, processing and medical devices, among many others. Around and around they all spin, like a white ivory pill (typically made of power transmission mainstay Delrin, by the way) on a roulette wheel, seeking out agents of all shapes, sizes and colors.

What they'll find is Achelpohl's "Four I's".

Let's start with *Innovation*.

"Pack Expo Las Vegas is the event to attend this fall to find winning processing and packaging solutions from top-tier suppliers," says Achelpohl. "Alongside Pharma Expo, it's the most comprehensive event of its kind. It's an unmatched opportunity to access an extraordinary breadth of solutions and suppliers."

One of those suppliers is Emerson Industrial Automation, a company that serves a handful of represented industries at Pack Expo including process, packaging and pharmaceutical. Emerson is a "premier" exhibitor and will have one of the largest presences at the show.

"It's an important show for us because it serves a lot of the industries

that fall under the automation market," says Derek Thomas, director and brand officer for Emerson Industrial Automation. "So when we look at places to go where we're going to get the most impact and exposure from the show, this is a perfect venue for us.

"It's a large event and it's really a very diverse audience from executives to maintenance professionals and everyone in between. It's a chance to talk with our customers face to face about the challenges they're facing every day. It's also a forum for us to introduce new technologies or new things that we're bringing to the world.

That brings us nicely to *Insights*.

Pack Expo has multiple stages dedicated to giving attendees a better understanding of the available break-



**36 Month Warranty**

**NEMA PREMIUM**  
Inverter Duty 15:1 Constant 30:1 Variable

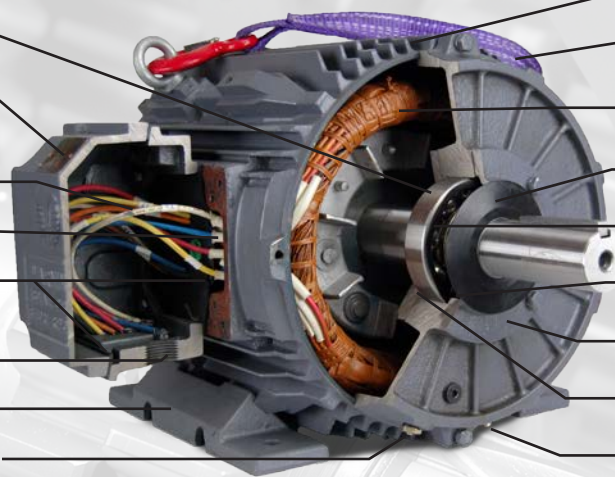

- Regreaseable Bearing (250T & Larger)
- Steel Connection Diagram Plate
- Color-coded Lead wires
- Lead Protection
- Gasketed Cast Iron Conduit box
- Threaded Conduit Entries
- Multi-mount Feet
- Bearing Grease Purge Valve

- Cast Iron Frame
- Lift Strap Included (254T & Larger)
- VPI Lap Wound Stator
- Rubber Slinger
- Oversized Bearings
- Double Lip Oil Seal
- Cast Iron Bearing Retainers
- Felt Shaft Wiper
- Brass Condensation Drain

**S**  
**E**  
**A**  
**L**  
**S**



SLINGER DOUBLE LIP

**D**  
**R**  
**A**  
**I**  
**N**



**L**  
**A**  
**P**  
**W**  
**O**  
**U**  
**N**  
**D**



**V**  
**P**  
**I**

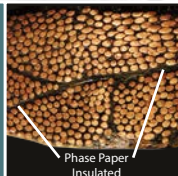

Phase Paper Insulated

**P**  
**U**  
**R**  
**G**  
**E**  
**V**  
**A**  
**L**  
**V**  
**E**

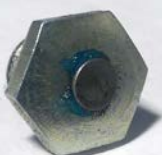

**WWW.TECHTOPIND.COM - 1-855-TECHTOP GET MORE MOTOR FOR YOUR MONEY!**

through technologies and techniques available to a variety of industries.

“Knowledge and understanding is the key to your success, and Pack Expo Las Vegas will open up doors to insights you can put into action,” Achelpohl says. “Valuable hands-on educational opportunities, conveniently located on the show floor, tap into the knowledge base of the industry’s most revered subject matter experts on breakthrough technologies and the latest regulations.

“Most of the educational opportunities are located on the show floor so you don’t miss a minute of the action. Innovation Stage will occupy three stages on the Pack Expo show floor (Booths C-1041, C-1045 and C-1049) and a fourth in Pharma Expo (Booth N-559), all with free, top-tier, 30-minute educational sessions running concurrently throughout each day of the show.

“Pharma Expo will also feature a world-class conference program organized by ISPE. The Center for Trends and Technology, sponsored by Rockwell Automation and its Partner Network, displays the latest in emerging automation trends—supplemented by cutting-edge learning sessions. Other educational features include The Food Safety Summit Resource Center, brought to you by the Food Safety Sum-



mit and co-sponsored by GE, Clemson University’s CU Shop, and the Reusables Learning Center, located in the Reusable Packaging Center.”

We’ll go ahead and combine *Interaction* and *Inspiration*, because participating and engaging in all the hands-on applications and conversing with industry experts will organically lead you from the former to the latter.

“When you’re at Pack Expo Las Vegas, you’ll be able to watch equipment in action and compare machines side-by-side to find solutions that apply directly to your production lines,” Achelpohl says. “You’ll connect with current and prospective suppliers, meet industry

peers and consult with experts. This is more than networking—you’re interacting with your industry.

“With more than 40 vertical markets represented, Pack Expo Las Vegas and Pharma Expo will provide a broad range of ideas as well as technologies. It’s a place for you to be inspired by applications outside your industry. This is that ‘cross-pollination of ideas.’”

### Baby, What a Big Surprise

There’s seems to be a cognitive dissonance when it comes to learning and leisure—and maybe that’s why Achelpohl unknowingly trimmed Pack Expo’s five essentials to four—but Pack Expo by and large understands that the two aren’t mutually exclusive.

The educational opportunities are the meat and potatoes of the show, sure. But this is Vegas—expect entertainment to be peppered in heavily throughout the three days.

“The processing and packaging supply chain is dynamic and high-energy, and Pack Expo shows are the best place to experience that,” Achelpohl says. “Equipment is up and running on every aisle, and people all around are talking and coming up with new ideas.

“But the buzz that runs through Pack Expo and Pharma Expo is more than the hum of machinery or chatter. It’s vitality. Attendees and exhibitors are seeing new, innovative technologies, making new connections and learning



new things. It's an exciting place to be."

Adds Thomas:

"It's always fun to see the innovation," he says. "Every year someone always brings something new and unique to showcase what's possible."

This year, Emerson hopes to be one of those companies pushing the boundaries and surprising the Pack Expo faithful.

"We're going to have a new machine that we developed with American Packaging & Plant Equipment," Thomas says. "It's a vertical machine that incorporates ultrasonic sealing technology. We really put a lot of our portfolio into that. We're going to be showcasing that, and it's really a new thing to the market and it's sort of our innovation along with APPE."

And if "innovative technology" doesn't put a grin on your face, you can always attend the Pack Gives Back charity event on Sept. 28, which will



feature a performance by prominent rock band *Chicago*.

We bet you can't help but crack a smile during "Saturday in the Park".

Unlike most well-wishing casino patrons trying to take down the house, we rather like our odds. **PTE**



## Precision Gear Technology at its best!



**Framo Morat**  
Franz Morat Group



**Customized gear engineering & drive solutions for solar tracking.**

### Reflector drive for Fresnel collectors

One drive swivels a mirror area of 650 ft<sup>2</sup>



### Tracking drive for mirror reflectors

A single drive moves a total mirror area of 3500 ft<sup>2</sup>.

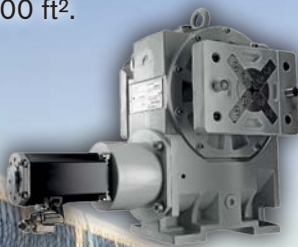

[www.framo-morat.com](http://www.framo-morat.com)

Local support in USA contact:  
[usa@framo-morat.com](mailto:usa@framo-morat.com) • #800-956-6728

# And the Winner Is...

## Allied Sinterings, FMS Corporation nab Grand Prizes at the 2015 Powder Metallurgy Design Excellence Awards Competition

Erik Schmidt, Assistant Editor

Winners of the 2015 Powder Metallurgy Design Excellence Awards Competition, sponsored by the Metal Powder Industries Federation, were recently announced at the POWDERMET2015 International Conference on Powder Metallurgy & Particulate Materials. Receiving grand prizes and awards of distinction, the winning parts are examples of PM's precision, performance, complexity, economy, innovation and sustainability. The winning parts show how customers from around the world are taking advantage of PM's design advantages.

### Grand Prize in the Automotive — Engine Category

Advanced Materials Technologies Pte Ltd. (Singapore), earned the Grand Prize in the Automotive — Engine Category for a MIM bus nozzle used in a selective catalytic reduction (SCR) system of European commercial vehicles. The nozzle performs the SCR function using urea and compressed air to reduce the NOx produced during combustion to N<sub>2</sub> and H<sub>2</sub>O. Made of an austenitic stainless steel (AISI HK30), the part employs a patented technology that uses a removable polymeric insert to form the complex internal undercut channel, a feature the fabricator deems "impossible" to achieve using conventional machining. All internal channels are achieved through MIM, while the threads on top are machined, and Micro TIG welding is used to seal the small openings left by the polymeric insert; tip flatness is achieved through a grinding operation. It is estimated that fabricating the nozzle through the welding/brazing of multiple parts would have increased its cost by more than 200 percent.



### Grand Prize in the Automotive — Transmission Category

FMS Corporation (Minneapolis, MN), was awarded a Grand Prize in the Automotive — Transmission Category for a thrust washer and two back-up washers made for its customer Allison Transmission. The com-



ponents play a critical role in the function of Allison's new TC10 automatic transmission for Class 8 (18-wheel) tractors. A first of its kind for the trucking industry, this 10-speed automatic transmission enables even inexperienced drivers to achieve 5 percent fuel savings over typical manual transmissions, thus contributing to a significant lowering of CO<sub>2</sub> emissions. Fabricated of a proprietary low-alloy steel, the three parts are warm compacted to achieve high green density, then vacuum sintered at high temperature, gas-pressure quenched, and tempered. They're produced very close to net shape, with only precision machining of some surfaces performed to improve the micro-finish as well as for dimensional accuracy. While these washers were an original PM design, they're estimated to save 30 percent over the cost of comparable forged/machined components.

"We were approached by the customer, who had gotten some information on a new material that we're using that has very high-strength properties and wear properties," says FMS Director of New Product Development Michael Corazzo about the winning product. "They came up with a few parts they thought would be a good application for [the product]. The testing was substantial. It's a transmission part that they offer a 750,000-mile warranty on, so they wanted to do their testing ten times that — so basically 10 million cycles. It took almost a year to do the testing, and now here we are.

"For us, it's a testament to some of the abilities of the people here at FMS [that we won the Grand Prize]. Most of the guys in the automotive industry have multiple plants around the world and revenues of billions of dollars, and we're the little guy lost up in Minnesota here. It's kind of like we're getting in with the big boys. It's an honor."

### Grand Prize in the Automotive — Chassis Category

Keystone Powdered Metal Company (St. Marys, PE), received the Grand Prize in the Automotive — Chassis Category for a rake cam, right-hand and left-hand guides, and an eccentric cam made for its customer Nexteer Automotive. The diffusion-alloyed steel components are used in Cadillac ATS and CTS, Chevrolet Impala, and GM Holden Commodore (Australia) steering columns. They're key elements of the column's tilt and telescope adjustment feature, serving a vital role in maintaining the column's position during a crash event. The multi-level parts are fabricated to net shape, with





in-line heat treatment and tempering being the only secondary operation performed to ensure the required hardness and strength. The rake cam has features that allow for a mechanical lock of the plastic overmold, in an operation performed by Agapé Plastics, Inc. The economic targets of the customer's preferred design for the steering column tilt/telescope adjustment and lock—with a "pin pocket" that gives a positive detent feel—could be met only with the flexibility offered by PM.

**Grand Prize in the Hardware/Appliances Category**

Allied Sinterings, Inc. (Danbury, CN), received the Grand Prize in the Hardware/Appliances Category for five conventional powder metallurgy (PM) components that are assembled in a planetary gearset. The parts—input flange, output flange, planet gear, sun gear, and ring gear—go into a self-contained single-stage gearset used in high-end lighting-control applications. The input and output flanges are made of nickel steel, the planet and sun gears of a low-alloy hybrid steel, and the ring gear of a sinter-hardened steel. The assembly is completed using a washer, spacers and dowel pins, easily producible or off-the-shelf items whose use was a specific objective of the gearset



design. Both flanges are produced net shape, requiring no secondary operations. The sun gear is designed as a compound gear, with the second gear serving as a spline for the mandrel. It and the planet gears are heat treated to increase their strength. The lower hardness requirement on the ring gear allows it to be made of a sinter-hardened powder. Tight tolerancing is essential for the gearset's quiet operation.

"It's an industry honor to be recognized by our peers," says Allied Sinterings President Mark Foster. "We're proud of the fact that we've made it eight years plus without a single failure and we have 100 percent on-time delivery. "It's just a testament to the good design."

**Award of Distinction in the Hardware/Appliances Category**

Indo-US MIM Tec Pvt. Ltd. (Bangalore, India) received the Award of Distinction in the Hardware/Appliances Category for two metal injection molded (MIM) 17-4 PH stainless steel parts—front and rear keepers that go into industrial electrical locks—made for Rutherford Controls Inc. The parts' complexity, with many cross holes and sharp knurl features, required the use of multiple slides, some moving at different angles. The parts are made close to net shape, re-



ORIGINAL SWEDISH STEEL

DESIGNED & MANUFACTURED ONLY BY

**ERASTEEL**

**FOR MORE INFORMATION ON ASP<sup>®</sup>,**  
 ERASTEEL'S UNIQUE RANGE OF POWDER METALLURGY  
 HIGH SPEED STEELS  
 CONTACT: ERASTEEL INC, TOLL FREE (800) 365 1152

[www.erasteel.com](http://www.erasteel.com)

quiring only a final coining to adjust a small distortion and a tapping operation on the front keeper. Annual quantities are 20,000 per part.

### Award of Distinction in the Electronic/Electrical Category

Indo-US MIM Tec Pvt. Ltd. (Bangalore, India) received an Award of Distinction in the Electronic/Electrical Category. The award was given for a metal injection molded (MIM) 17-4 PH stainless steel shell made for Hirose Korea Co. Ltd. The part goes into a charging assembly for mobile phones. The complex geometry of the part, with thin cross sections and internal undercuts, was achieved with a slide-in-slide mechanism moving on specially designed cam tracks. The MIM part replaced an earlier design that used sheet metal processing and welding, with an estimated 20 percent cost savings. Two million of the parts are delivered each month.

An Award of Distinction in the Electronic/Electrical Category was also earned by Indo-US MIM Tec Pvt. Ltd. for two other parts—a male fool-proof device and a female polarizer—made for Amphenol Air LB France. Made via metal injection molding (MIM) from 4340 low-alloy steel, the parts go into an electric connector assembly made for Airbus. Both parts are fabricated to net shape, with all dimensions achieved in the as-MIM condition; this includes the threads, which are formed through auto unwinding in the tooling. The fabricator delivers 320,000 pieces annually.

### Award of Distinction in the Hand Tools/Recreation Category

Porite Taiwan Co. Ltd. (Chunan, Miao-Li, Taiwan) earned an Award of Distinction in the Hand Tools/Recreation Category for five components comprising an output gearbox that serves as feedback for an anti-twist lock on a drill driver.



The parts — intermediate flange, anti-twist lock, mount ring, centering sleeve and planet gears—are made from diffusion-alloyed steel. The flange is compacted using two upper and two lower punches, and powder moving technology is employed to achieve a more uniform density distribution. Tight tolerances at the inner and outer diameters are accomplished through machining, and a milling operation provides the holes needed for part assembly. The parts' design, with extremely thin sections and complicated geometries, required precise control by a CNC compacting press. The powder metallurgy (PM) design saved more than 40 percent over the cost of manufacturing through forging and machining. **PTE**

For Related Articles Search

powder metal

at [www.powertransmission.com](http://www.powertransmission.com)

# NACHI

## Ball & Roller Bearings

### Superior Quality ~

### Higher Efficiency, Longer Life

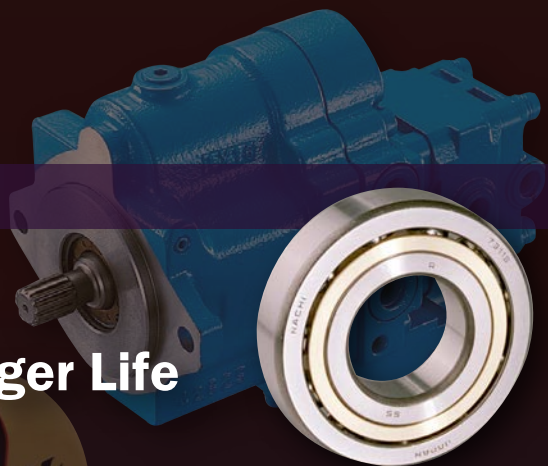

### Bearings Division

715 Pushville Rd  
Greenwood, IN 46143  
888-340-2747

Fax: 888-383-8665

[bearings@nachi-america.com](mailto:bearings@nachi-america.com)

[www.nachi-america.com](http://www.nachi-america.com)

# COBO HALL

DETROIT, MICHIGAN

October 20 & 21, 2015

*Gear Technology* Presents

## ASK-THE-EXPERT LIVE!

An All-Star Review, Featuring Some of the TOP NAMES in Gear Technology.

Bring your toughest gear manufacturing questions and get the answers, LIVE on the show floor:

- **GEAR GRINDING** – Tuesday, 10/20 – 10:30 a.m.
- **CUTTING TOOLS** – Tuesday, 10/20 – 2:00 p.m.
- **GEAR DESIGN** – Wednesday, 10/21 – 10:30 a.m.
- **ASK ANYTHING** – Wednesday, 10/21 – 2:00 p.m.

Booth # 2030, Gear Expo  
Cobo Hall, Detroit Michigan



# Power Transmission Engineering

NO SEATS RESERVED

# Belts Vs. Couplings

## THE QUESTION

Are there special criteria for using belts or couplings as power transmitters for rotary-type blowers? Examples: for motor KW; RPM; temperature; pressure production; lifetime; etc.

In other words, how do I choose between belts or couplings?

In our company we require a rotary-type blower (main blower) for a gas plant application, and some vendors offer belts as power transmitters; but our licensor indicates coupling as the power transmitter. So it would be appreciated if you could provide me with some evidence of which is best for us.

Expert responses provided by: Andy Lechner (sales manager) and Nillo Nykanen (senior applications engineer)—R+W America ([rw-america.com](http://rw-america.com)); and Don Labriolla (president)—QuickSilver Controls ([Don\\_Labriolla@QuickSilverControls.com](mailto:Don_Labriolla@QuickSilverControls.com)).

**Lechner:** What I can tell you is that, while it may or may not be applicable here, belts are often a highly effective way of achieving a low-cost gear reduction between motor and machine, potentially saving up-front investment dollars while also saving space, in some instances, in addition to offering vibration damping and misalignment compensation. They can, however, be considered a wear item. Especially in the oil and gas sector, maintenance-free solutions are very popular. This same industry was responsible for the initial development of the flexible disc pack coupling, which is a style designed for fatigue resistance and a theoretically infinite service life—without any lubrication or replacement parts required. This could have something to do with why the licensor has requested couplings in this particular instance.

**Nykanen:** Couplings or belts are used to drive industrial rotary blowers. Small radial fans such as regenerative blowers are often direct-coupled with inexpensive, rigid couplings. This is possible through precision casting and machining in large production quantities which allows for



pilot mounting motor and blower—essentially eliminating the labor of alignment. Medium-to-large centrifugal fans are either belt- or coupling-driven. These systems often use inexpensive, elastomeric coupling or belt drives that result in fairly easy installation, with rudimentary alignment typically necessary. Economy- and mid-cost-range positive displacement blowers often use v-belt drives. The belt drive allows for flow and pressure adjustment by changing the size of the pulleys. Low-to-mid-cost systems often use mass-produced, low-precision cast metal or molded plastic parts. Most of these blowers are operated in an open-loop electrical system with a start/stop switch being the only control. High-end screw and helical lobe machines use either direct-drive or belt drives, depending on system requirements. Expensive air-movers often employ sophisticated electronics such as variable frequency drives, sensors, and controls that operate in a closed-loop system that dynamically adjusts to operating conditions using PID controls. High-cost systems often demand precision-made coupling systems that tend to be machined from quality metals custom-specified for the application.

Indirect-drive belts are economical and easily allow for connection of a motor (shafts in parallel) in many orientations to a piece of driven equipment. Due to the multiple connection options, belts allow options for many space constraints. Elastomeric belting also adsorbs mechanical vibration and takes up misalignments. V-belts are a common choice with positive-displacement blowers and

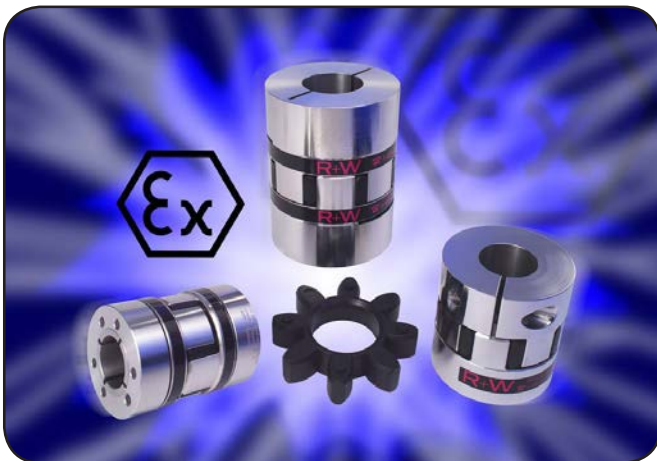



some centrifugal blowers. In a blower system, flow and pressure are controlled by driven speed. Belt sheaves function like gears by increasing or decreasing motor speed ratio to achieve desired system parameters. After a belt-driven machine and the motor are in place and lined up, removing the belts can normally be done without unbolting anything but the sheaves, making maintenance easy. A no-load motor test or belt and sheave change can take as little as a few minutes once the guarding is removed. However, belt sizing can be tedious using manual calculations; computer selection software offered by major manufacturers can alleviate this. With belt drives, overhung shaft loads must always be considered and manufacturers of economy blowers often do not allow for enough bearing loads to give the drive designer many options in choosing belts. This often leads to custom guarding, which can add considerable cost to a system. Due to a constant radial load on bearings with belts, there is a decrease in lifespan vs. direct-driven machines. Elastomeric belts are also a wear item that essentially stretch out over time and need to be manually or automatically tensioned throughout the life of the belt — creating a need for maintenance or purchase of an additional automatic belt tensioner.

Direct-drive (shaft-to-shaft) couplings for blowers are normally fairly simple to size, often by simply looking at a catalogue page and evaluating torque, speed and safety factors. Often, standard off-the-shelf guarding can be used, resulting in a bit of cost and labor savings. A well-aligned coupling places little radial pressure on bearings, thus increasing their life. Also, losses in mechanical efficiency can be somewhat reduced via direct-drive by saving some electricity. Although most couplings offer a 1:1 speed ratio, limiting speed to number of motor poles (in the case of standard AC motors), they are often used in conjunction with variable frequency drives that offer many electrical and mechanical advantages for blower systems. A common example of this is programming a soft start and constant torque, or current limiting. Many VFDs also can be wired with sensors that provide PID speed control to maintain constant pressure in a blower system; this is very common when variable orifices in pipework are present, e.g., filters and valves.

Another advantage with direct-drive couplings for blower systems is that several prominent manufacturers offer ATEX-certified couplings that provide electrical continuity between shafts and prevent sparking. Many blowers and motors are specifically designed to operate in ATEX or NEMA

hazardous locations and are name-plated accordingly. This is especially important and is often specified by system designers in the gas and fuel processing industries. Couplings used in high-end equipment can be precisely machined and balanced, which can impact budgets and lead times. Thus great care must be taken in shaft alignment and in planning the installation projects for these systems. Custom-wound-and-name-plated electric motors can have lead times of several months; the same applies for blowers and drive components — especially when material certificates and specific countries of origin become a factor.

In conclusion, a designer behind a gas blower system likely would choose a direct-coupling over belt drive for the reasons given above. A belt drive usually requires more maintenance than a coupling. Given the highly competitive nature of processing a commodity product, downtime for maintaining the system is a huge factor in determining the parts to be used. Also, there are more options for couplings operating in hazardous locations than there are for belts in most markets, affording the system designer a wider variety of choices.

**Labriolla:** Full-disclosure — I do not typically work with blowers, but in general motion the two main issues between couplers are usually 1) geometry and 2) speed ratio. (System stiffness may be a third, but is not likely related to blowers.)

**Geometry of the layout:** With a belt the motor can be in the same width as the blower, sometimes making a more compact configuration, whereas the coupler forces an in-line configuration.

**Speed ratio:** A belt can be used to change the speed — to make the fan turn slower (or faster) than the base motor by making the pulleys different diameters. The belt can also be used to move the motor out of the opening of the fan — i.e., away from the central axis of a blower to reduce turbulence and help increase air flow. This is really dependent upon the layout of the blower.

Finally, the belt may reduce acoustical noise transmitted between motor and fan; this may or may not be important, dependent upon the particular application.

The coupler has advantages in that it may not need as much finger protection from pinch points and often has less maintenance and slightly lower losses. **PTE**

# A New Geometrically Adaptive Approach for Tooth Contact Analysis of Gear Drives

Francisco Sanchez-Marin, Alfonso Fuentes, Jose L. Iserte and Ignacio Gonzalez-Perez

Tooth contact analysis (TCA) is an important tool directed to the determination of contact patterns, contact paths, and transmission errors in gear drives. In this work, a new general approach that is applicable to any kind of gear geometry is proposed.

## Introduction

Tooth contact analysis is a tool to simulate the meshing of gear drives being a very important resource to predict its performance. The main hypotheses of the TCA are that the transmission is considered unloaded and that the tooth contact surfaces of the gears are rigid. On the other hand, the two main results of the TCA are the contact pattern of the gearset and the function of transmission errors that represents the performance of the gearset.

The first works of development of TCA were done by Litvin and Kai (Refs. 1–2), and Baxter (Ref. 3), followed by the engineers of Gleason Works (Ref. 4). From then, a number of researchers proposed new approaches with different objectives encouraged by the increasing computation power of modern computers.

In more recent works, Vogel et al (Ref. 5) proposed a constructive approach for the contact analysis of hypoid bevel gears where the paths of contact, the transmission error and the contact ellipses are obtained directly by modelling the underlying virtual machine tool and its derivatives. Litvin et al (Ref. 6) developed a numeric approach for tooth contact analysis including the automatic determination of the guess values for derivation of the first contact point of tooth surfaces. Vecchiato (Ref. 7) extended the principles of TCA for the simulation of meshing of a planetary gear drive with a set of planets. Simon (Ref. 8) proposed a method for computer aided tooth contact analysis in spiral bevel gears for the investigation

of the influence of machine tool settings on the path of contact, potential contact lines, separations along these lines and on angular position error of the driven gear. Bracci et al (Ref. 9) presented a geometric approach to the estimation of the contact pattern of a hypoid gear drive where tooth, gear body, shaft and housing deformations are approximately taken into account by properly selecting the marking compound thickness and topography. Sobolewski et al (Ref. 10) proposed an approach for tooth contact analysis based on the use of a CAD environment for spiral bevel gearsets with tooth flanks represented as CAD free-form surfaces.

In this work, a new approach for unloaded TCA is proposed with the following objectives:

- must be general and applicable to any type of gear, including types with line contact and types with point contact
- must work properly for any relative position of the tooth contact surfaces, including both aligned and misaligned (in any way) relative positions
- final accuracy must be parameter-dependent, to be able to be controlled by the client of the approach
- computational cost must be as low as possible

The proposed method is a geometric approach based on the discretization of the tooth contact surfaces and the progressive adaptive refinement of the obtained meshes to solve the contact problem and to compute the instan-

taneous contact area for each position of the gearset along the gearing cycle. The approach requires the existence of a mathematical model (in the form of a parametric function) of the contact surfaces that involves the solution of the gearing Equation 11. It also requires the existence of an algorithm to obtain a basic triangle mesh of the tooth contact surface, including determination of the tooth contact surface limits based on the defining parameters of the gear.

## Algorithm to Compute the TCA

The TCA algorithm has the objective of solving the contact problem for different positions of the gearset along the gearing cycle and computing the transmission error and instantaneous contact area for each position. The angular position of the gearset is defined here by the angular position of the pinion and the final angular position of the wheel is the one that brings the wheel in contact with the pinion.

The first part of the algorithm solves the positional contact problem for a number of equally separated positions of the gearing cycle. The number of positions is specified by the angular increment of the pinion that is computed as the pinion step angle divided by a number. The detection of the limits of the gearing cycle for the reference teeth pair is computed by solving the positional contact problem for both the following and previous teeth pairs, and then determining which teeth pair contacts first for each specific position of the pinion.

This paper was originally presented at the 2014 International Gear Conference, Lyon Villeurbanne, France and is republished here with the authors' permission.

In the second part, the algorithm uses the angular position of the wheel to be in contact with the pinion, obtained in the first part. Then, for each position of the pinion (that is, for each position of the gearset), it computes the transmission error and the instantaneous contact area, ending the approach.

### Algorithm to Solve Positional Contact Problem

This algorithm solves the tooth contact problem for a reference teeth pair (one pinion tooth contacting with one wheel tooth) and for a specific position of the gearset (positional problem). Thus the algorithm starts from a given angular position of the pinion tooth and an initial position of the wheel tooth (not necessarily in contact), and has the objective of computing the angle that is necessary to rotate the wheel from that position for the wheel tooth to contact the pinion tooth. The algorithm has been designed to be independent from the relative position of the gears, being suitable when the gears are aligned and when they are misaligned in any way.

The input parameters of the algorithm are:

- *Triangle refinement goal size*: the meshes are refined around the contact point until the size of the mesh triangles is under this value.
- *Tolerance for angle of rotation to contact the opposite mesh (or angular tolerance)*: this value delimits the area of the contact surfaces that is going to be refined in each loop iteration (see step 3). This value is reduced from iteration to iteration to reduce the refinement area around the contact point.

**The algorithm includes the following steps:**

**Step 1:** The algorithm gets a basic triangle mesh of pinion and wheel contact surfaces. These meshes are moderately coarse and define the limits of the contact surface. The pinion mesh is at the pinion position of computation and the wheel mesh is at the initial reference position of the wheel.

**Step 2:** For each node of the wheel mesh, the angle of rotation around the wheel axis for the wheel node to contact the pinion mesh is computed. Reciprocally, for each node of the pinion mesh, the angle of rotation around the wheel

axis for the pinion node to contact the wheel mesh is computed. Thus, each node has an associated value of angle of rotation to contact the opposite mesh.

**Step 3:** The angular tolerance is used to refine the wheel mesh. This way, all triangles having nodes with an associated value of angle of rotation to contact the pinion mesh under the tolerance of refinement are split adding a new node in the midpoint of the longest edge. The position of the new nodes is updated to be on the contact surface and its angle of rotation to contact the pinion mesh is computed.

**Step 4:** The angular tolerance of is used to refine the pinion mesh. The procedure is the same as it was explained in step 3 for the refinement of the wheel mesh.

**Step 5:** The algorithm checks if the required size of triangles has been reached to exit the loop. If the size of all refined triangles in pinion and wheel meshes is under the triangle goal size, the algorithm jumps to step 7, exiting the loop.

**Step 6:** The angular tolerance is reduced to decrease the mesh portion to be refined in next iteration and, then, the algorithm jumps to step 3.

**Step 7:** Compute the lowest angle of rotation of the wheel to contact the pinion mesh. The contact point on the pinion mesh and the contact point on the wheel mesh.

The results (output) of this algorithm are the angle that is necessary to rotate the wheel around its own axis for the wheel tooth surface to contact the pinion tooth surface, being the pinion at the specified position, and the contact points in both contact surfaces.

### Algorithm to Compute the Instantaneous contact area

Given the pinion and wheel reference teeth pair in contact for a specific position of the pinion, this algorithm has the objective of obtaining the instantaneous contact area associated to a specific distance value: i.e., the virtual marking compound thickness.

The input parameter of the algorithm is:

- *Virtual marking compound thickness (VMCT)*: it is the distance value that defines the instantaneous contact areas on both pinion and wheel teeth. Thus, the instantaneous contact areas on the pinion (resp. wheel) is composed by the points of the contact surface that are at a distance from the wheel (resp. pinion) surface that is equal to the VMCT.

**The algorithm includes the following steps:**

**Step 1:** the algorithm gets a basic mesh of pinion and wheel contact surfaces being the reference teeth pair in contact for the specified position of the pinion.

**Step 2:** for each node of the wheel mesh, the distance from the wheel node to the pinion mesh is computed. Reciprocally, for each node of the pinion mesh, the distance from the pinion node to the wheel mesh is computed. Therefore, each node of each mesh has an associated value of distance to the opposite mesh.

**Step 3:** the VMCT is used to refine the wheel mesh. This way, all triangles having nodes with associated over and under the VMCT are split adding a new node in the midpoint of the longest edge. The position of the new nodes is updated to be on the contact surface and its distance to the pinion mesh is computed.

**Step 4:** similar to step 3, the VMCT is used to refine the pinion mesh.

Table 1 Gearset data

	Pinion	Wheel
Type	Standard spur	
Module	1 mm	
Pressure angle	25 deg	
Num. of teeth	20	34
Addendum	1 mm	1 mm
Dedendum	1.25 mm	1.25 mm
Face width	10 mm	10 mm
Centre distance	Standard	

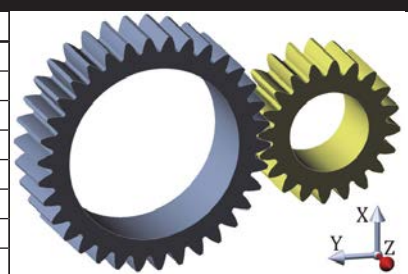

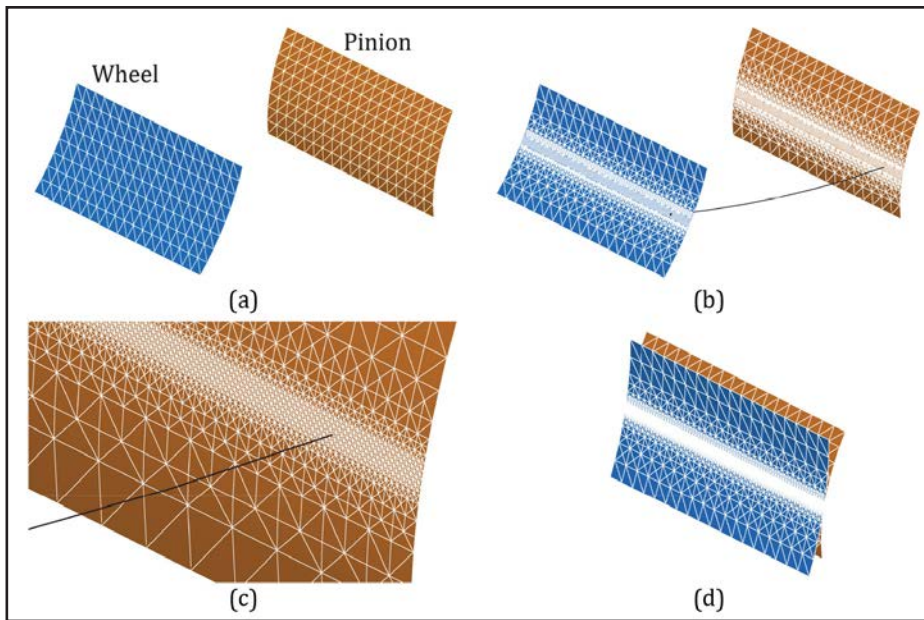

Figure 1 Results of the positional contact problem for case I.

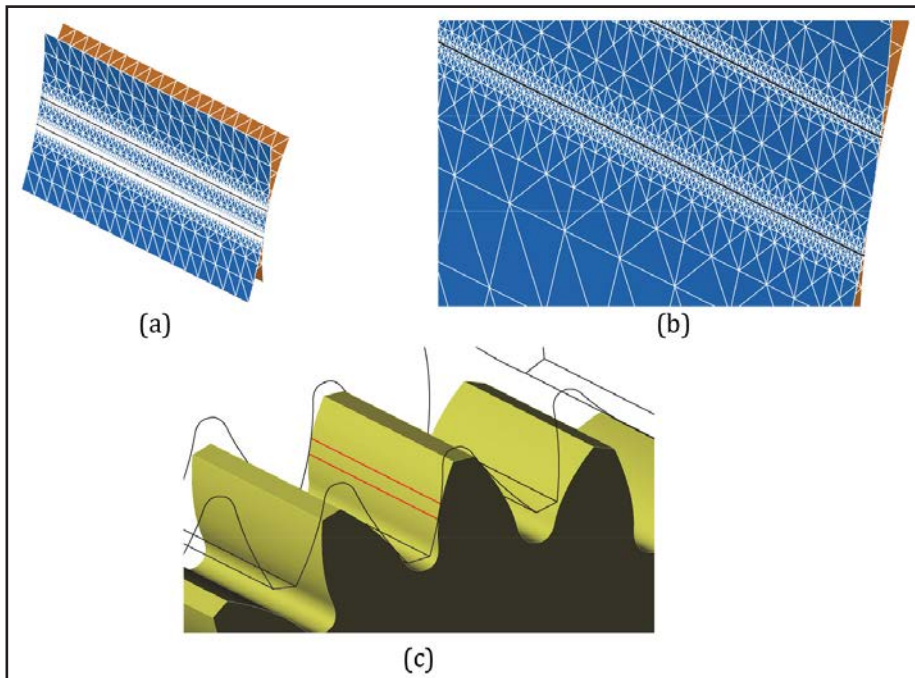

Figure 2 Computation of the bearing contact and transmission errors for case I.

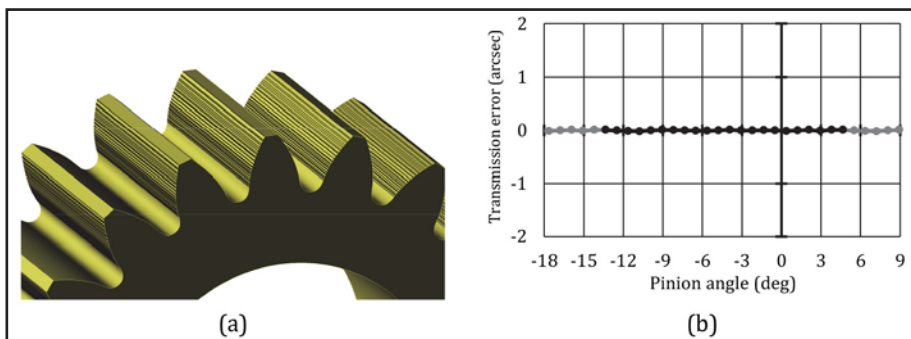

Figure 3 Final results of the TCA algorithm for case I.

**Step 5:** the algorithm checks if the required size of triangles has been reached to exit the loop. From the previously refined triangles, if there are triangles with size over the triangle goal size, the algorithm jumps to step 3. Otherwise, the algorithm continues with step 6.

**Step 6:** compute the instantaneous contact areas from the pinion mesh by linear interpolation from the distance values associated to the nodes. Similarly, computes the bearing contact curve from the wheel mesh. The results (output) of this algorithm are the instantaneous contact areas corresponding to the pinion and wheel teeth for the initial contact position of this reference teeth pair.

### Test Cases and Discussion

The proposed approach has been tested in this work with a spur gearset. This type of transmission is a good test example because it has a line contact when the gearset is aligned, and that supposes an important difficulty for other TCA approaches. On the other hand, when the gears have an angular misalignment, there is a point contact and the bearing contact shifts to one of the edges, what makes it a good test for the approach as well.

The parameters of the used spur gearset are shown in Table 1. The global size of the gears is not relevant for the proposed approach, so an arbitrary value of the module has been selected. The rest of the parameters have been assigned with typical and normalized values.

**Case I: standard spur aligned gearset.** In the first test case, the spur gears are perfectly aligned. The TCA algorithm has been executed obtaining the contact pattern and the transmission errors along the gearing cycle. For each position of the gearing cycle, the algorithm solves first the positional contact problem and, then, computes the bearing contact. For both problems, a value of 0.05 mm has been used for the triangle refinement goal size. For the computation of the bearing contact, a value of 0.0065 mm has been used as virtual marking compound thickness (VMCT).

Given a specific position in the gearing cycle, the algorithm to solve the po-



sitional contact problem starts with a basic triangle mesh of pinion and wheel contact surfaces (Fig. 1a). After computing the contact with successive refinement of both meshes, the contact point and the angle that is necessary to rotate the wheel to contact the pinion is obtained (Fig. 1b). Figure 1c shows a detail of the pinion refinement to determine the contact point on the pinion surface. It can be observed how the area close to the contact line has been adaptively refined. Finally, Figure 1d shows both refined meshes in perfect rigid contact.

After solving the contact problem, the algorithm computes the instantaneous contact area starting with the same basic triangle mesh of pinion and wheel contact surfaces (Fig. 1a) but being the meshes at the previously obtained contact position. Then, the refinement iteration is performed and the resulting instantaneous contact areas for pinion and wheel are obtained (Fig. 2a). A detail of the refinement of the meshes to obtain the instantaneous contact areas is shown in Figure 2b. The final representation of the instantaneous contact area on the pinion is shown in Figure 2c. It can be observed that the algorithm predicts a instantaneous contact area according to the expected line contact.

Finally, Figure 3 shows the results of the TCA algorithm: contact pattern for the pinion (Fig. 3a) and the transmission error graph (Fig. 3b). Since the gears are perfectly aligned and the tooth geometry is standard (involute) for both gears, a full side contact pattern and a zero transmission error were expected. The graph shows in black the transmission errors for a pinion step angle ( $18^\circ$  in this example) that corresponds to a gearing cycle.

**Case II: standard spur misaligned gearset.** In the second case, the wheel has been misaligned with respect to the pinion. The imposed misalignment consisted in the displacement of the wheel  $-0.5$  mm along the Z axis and the rotation of the wheel  $0.1^\circ$  around the X axis (see axis in Fig. 1). Similarly to case I, Figure 4 shows the intermediate results of the algorithm to solve the positional contact problem associated to a specific position of the gearing cycle. It can be observed how the contact type is point contact due to the misalignment and how the algorithm refines the mesh adaptively to compute the

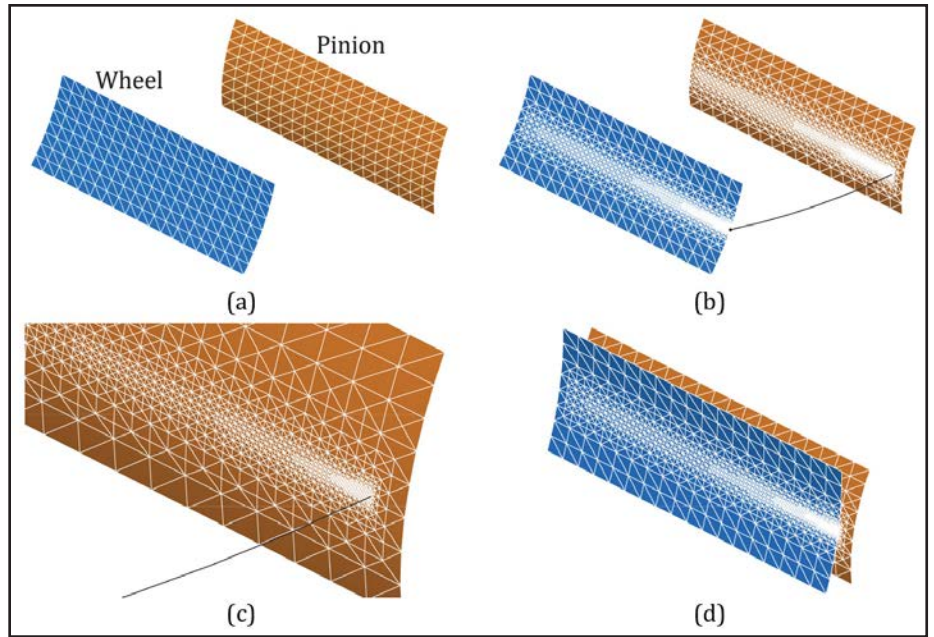

Figure 4 Results of the computation of the bearing contact for case II.

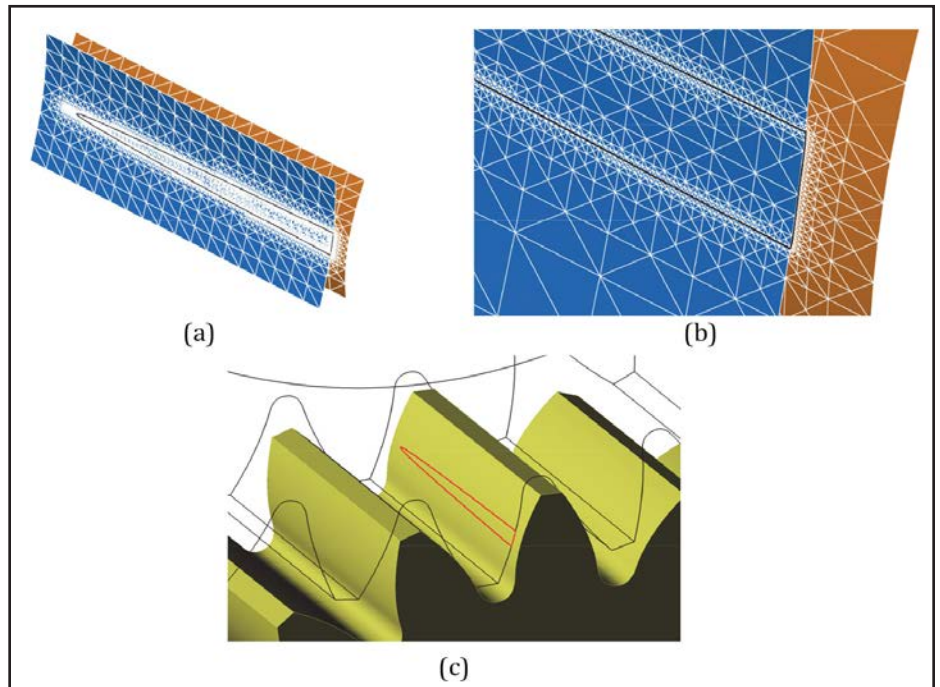

Figure 5 Results of the positional contact problem for case II.

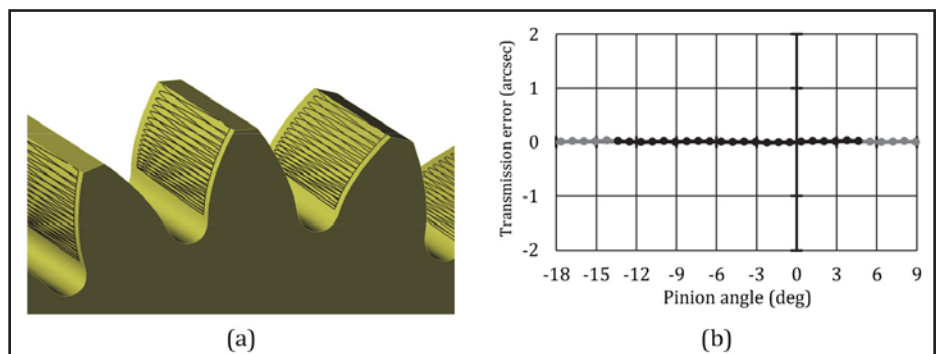

Figure 6 Final results of the TCA algorithm for case II.

contact point.

On the other hand, Figure 5 shows the intermediate results of the algorithm to compute the instantaneous contact areas. It can be observed that the adaptive refinement to compute the instantaneous contact areas associated to the value of the virtual marking compound thickness and the precision of the obtained curve in both meshes.

Finally, Figure 6 shows the results of the TCA algorithm. The obtained graph in Figure 6b indicates that the combination of the small face width with the small imposed angular misalignment does not generate significant transmission error along the gearing cycle.

## Conclusions

In this work, a new geometrically adaptive geometric approach for the tooth contact analysis of gear drives has been proposed. The new approach solves the positional contact problem and the computation of the instantaneous contact area. The provided results of the approach are the transmission errors along the gearing cycle, the instantaneous contact area at any position of the gearing cycle and the contact pattern. The approach is general, independent of the gearset type and of the relative position of the gears, which makes it very versatile. The precision of the results is dependent on the degree of refinement that can be decided by the user.

The approach has been tested with two cases, one providing line contact and the other providing point contact due to misalignment and the approach has been demonstrated to adapt very well to the inherent geometric problem and to obtain very precise results in very low computational times.

## References

1. Litvin, F.L. and G. Kai. "Investigation of Conditions of Meshing of Spiral Bevel Gears," *Proceedings of Seminar of Theory of Mechanisms and Machines*, 1962, 92-93 (in Russian).
2. Litvin, F.L. and G. Kai. "Improvement of conditions of meshing of spiral bevel gears," 1964, *Proceedings of Seminar of Theory of Mechanisms and Machines*, 98-99 (in Russian).
3. Baxter, M.L. "Basic Geometry and Tooth Contact of Hypoid Gears," 1961, *Ind. Math.* 1-28.
4. Gleason Works. *Understanding Tooth Contact Analysis*, 1970, Rochester, NY.
5. Vogel, O., A. Griewank and G. Bär. *Comput. Methods Appl. Mech. Engrg.*, 2002, 191, 3965-3982, doi: [http://dx.doi.org/10.1016/S0045-7825\(02\)00351-1](http://dx.doi.org/10.1016/S0045-7825(02)00351-1).
6. Litvin, F., G. Sheveleva, D. Vecchiato, I. Gonzalez-Perez and A. Fuentes. *Comput. Methods Appl. Mech. Engrg.*, 2005, 194, 2927-2946, doi: <http://dx.doi.org/10.1016/j.cma.2004.07.031>.
7. Vecchiato, D. *Mechanism and Machine Theory*, 2006, 41, 617-631, doi: <http://dx.doi.org/10.1016/j.mechmachtheory.2005.10.001>.
8. Simon, V. *Mechanism and Machine Theory*, 2007, 42, 365-381, doi: <http://dx.doi.org/10.1016/j.mechmachtheory.2006.02.010>.
9. Bracci, A., M. Gabiccini, A. Artoni, and M. Guiggiani. *Comput. Methods Appl. Mech. Engrg.*, 2009, 198, 1536-1571, doi: <http://dx.doi.org/10.1016/j.cma.2009.01.009>.
10. Sobolewski, B. and A. Marciniak. *Aircraft Engineering and Aerospace Technology*, 85/6, 467-474, 2013, doi: <http://dx.doi.org/10.1108/AEAT-11-2012-0207>.
11. Litvin, F. and A. Fuentes. *Gear Geometry and Applied Theory* (2nd Edition), 2004, Cambridge University Press, New York.



### Francisco Sanchez-Marin

- Associate Professor at the Department of Mechanical Engineering of the University Jaume I (Castellon, Spain) and Principal Investigator of the Gear Drives Research Group (GITE). MS in Mechanical Engineer by the Polytechnic University of Valencia (Spain, 1994). Product Manager in IBM (Valencia, Spain). Ph.D. in Mechanical Engineering by the University Jaume I (Castellón, Spain, 2000). Author of different books and research papers on maintenance, biomechanical engineering, mechanism synthesis and gear transmissions. More than 19 years of teaching experience in mechanical engineering courses. Member of the Mechanical Engineering Spanish Association (AEIM).



### Alfonso Fuentes

- Principal Investigator of the Enhanced Gear Drives Research Group (GITAE). Mechanical Engineer (1993). Ph.D. in Mechanical Engineering (1996). Full Professor at the Polytechnic University of Cartagena at present. Author of more than 70 publications and 4 books. Involved in computerized development of improved gear transmissions applied in helicopters and automotive industry, development of enhanced computer models of gears for stress analysis and development of computer programs for generation and simulation of meshing of low-noise, stable bearing contact spiral bevel gears with improved geometry. Member of the Editorial Board of the Journal Mechanism and Machine Theory, the Open Mechanical Engineering Journal and the Recent Patents on Mechanical Engineering Journal. Member of the American Gear Manufacturers Association (AGMA) and the American Society of Mechanical Engineers (ASME).



### Jose L. Iserte

- Associate Professor at the Department of Mechanical Engineering and cofounding member of the Gear Drives Research Group of the Universitat Jaume I. Mechanical Engineer by the Polytechnic University of Valencia (Spain, 1997). Professional experience as a mechanical engineer in the Technical Division of the Astrophysics Institute of Canarias (Spain, 1999). Ph.D. by the Polytechnic University of Valencia (2005). Teaching experience in Machine Theory and Mechanisms. Member of the Mechanical Engineering Spanish Association (AEIM) since 2011.



### Ignacio Gonzalez-Perez

- Associate Professor at the Department of Mechanical Engineering of the Polytechnic University of Cartagena (Spain, 2009). Ph.D. by the Polytechnic University of Cartagena (Spain, 2003). Mechanical Engineer by the University of Murcia (1999). Author of more than 30 publications. Teaching experience in Machine Element Design for more than eight years. Research experience in Theory of Gearing and Applications since year 2001. Member of the American Gear Manufacturers Association (AGMA) and the American Society of Mechanical Engineers (ASME).



# Hungry for More?



Everything you need if you buy gears, bearings, motors, couplings and clutches.

## Power Transmission Engineering

- Product and Industry News Updated Daily
- Directory of Mechanical Power Transmission Suppliers
- Exclusive online content in our e-mail newsletters
- Back Issues and Article Archive
- Calendar of Upcoming Events for power transmission professionals

FREE SUBSCRIPTION!

[www.powertransmission.com](http://www.powertransmission.com)

# The Importance of Thermal Protection for Torque Motors

Brian Zlotorzynski

When talking about high-end machining or manufacturing applications that include direct-drive technology, one of the key advantages of utilizing this particular transmission method is its endurance. Because of the very nature of direct-drive motors they are able to operate at peak performance levels indefinitely — without any kind of wear or aging — as long as the motor isn't pushed past its capacity. Unfortunately, because this isn't a perfect world, unexpected things can happen which can cause the motor to overheat. Whether the heat source is due to a parameter being input incorrectly, or an unexpected external force causing more resistance than expected — it is important to have certain forms of thermal protection in place. Since torque motors are built in such a way that they cannot be repaired and yet maintain their efficiency, it is vital to prevent any overheating — thus precluding the need to purchase a new one.

There are currently a number of ways in which torque motors can be protected from overheating; they include having the controls monitor and maintain a certain amount of current, or using physical temperature sensors. Following are some of the methods possible to ensure optimum motor protection.

**$I^2t$  values.** Within controls, the algorithms that monitor the current being used are referred to as an  $I^2t$  value. There are variations on how it is calculated depending on whose programs are used, but the principle is always the same.  $I^2t$  is an algorithm that is a function of time and current, so it uses the amount input into the motor over time and sets a limit on how much can be applied before overheating. To give an example of this, we'll take a look at the  $I^2t$  programming in Etel's AccurET control driver (Fig. 1).

A value of KF84 is set, as determined by the model of the motor. As the amount of current used goes above and below this value, integration begins. If the current remains above the selected KF84 value for too long, and the integral reaches its limit of KF85, then an  $I^2t$  error occurs. There is also an over-current limit at KF83 that sets a limit — regardless of any integration value.

Most drivers have some form of current-monitoring method to prevent overheating, and it is a way to use the motor's continuous current value to prevent motor damage at the electronics level.

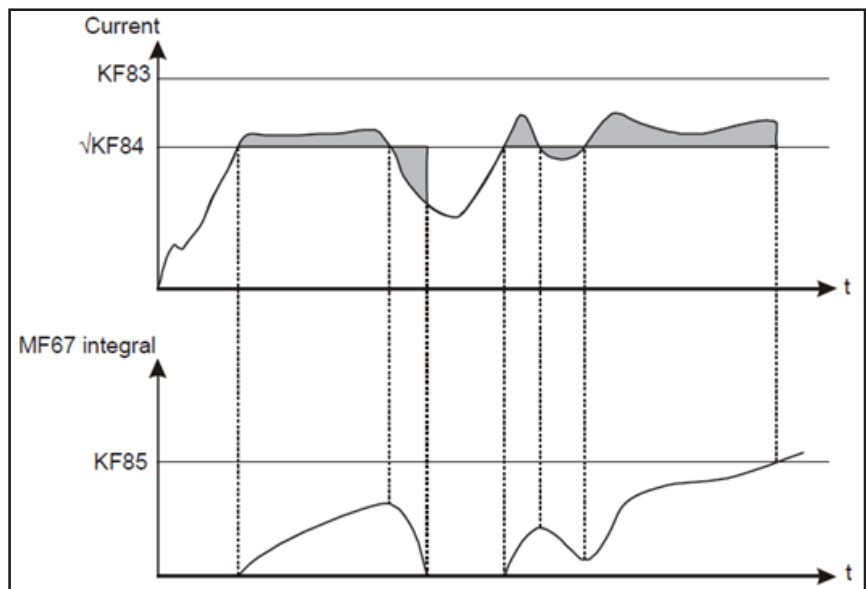

Figure 1 A value of KF84 is set, which is dependent on the model of the motor. If the current reaches its limit of KF85 — an  $I^2t$  error occurs.

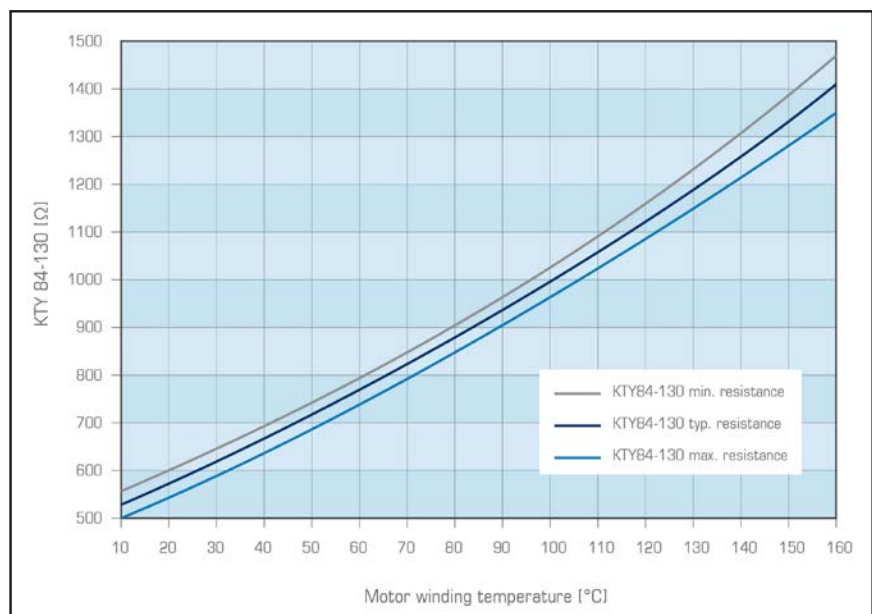

Figure 2 KTY sensors are silicon temperature sensors that have resistance values that change based on its temperature.

**Temperature sensors.** There are many types of motor temperature sensors on the market, but the focus here will be on some of the common ones; they are KTY, SNM, and S01 sensors.

**KTY.** KTY sensors are silicon temperature sensors that have a resistance value that changes based on temperature. The relationship between the temperature in the windings and between the resistance value the sensor outputs is linear (Fig. 2). Although KTY sensors are considered the most accurate of the three mentioned, one must compensate for a delayed response since the change in resistance is not instantaneous enough to detect sharp changes in temperature.

**SNM.** An SNM sensor is typically used in low-voltage circuits and is meant to be connected to a controller working at an electronic voltage level typically around 5 VDC. Like a KTY sensor, it outputs a resistance value based on the temperature, but the change is a lot sharper (Fig. 3).

**S01.** An S01 sensor is a limit switch based on a bi-metallic mechanism. It is a digital signal that reads as either open or closed. If desired, it can directly cut off the power of some electronics in overheating scenarios, as it operates more as a “switch” rather than having a temperature/resistance relationship. It is able to operate in a medium- to high-voltage range of around 50 VDC.

**Sensor configuration.** There are two kinds of standard temperature configuration ETEL utilizes for its torque motors (Fig. 4). The first is Configuration 8, which not only uses each type of sensor, but has all three phases monitored. Although the option for having all three sensor types is available, it is Configuration H that is recommended since there is a spare set of KTY sensors on each of the phases. This is important because KTY sensors — while the most accurate of the different types — are electrostatic-sensitive devices (ESDs), and there are many stages in the machine assembly process where the sensors can be damaged; having an extra set ensures that it wouldn’t be necessary to have the entire motor replaced on the off-chance one of them is damaged.

**Stall conditions.** It is important to note that in each of the different config-

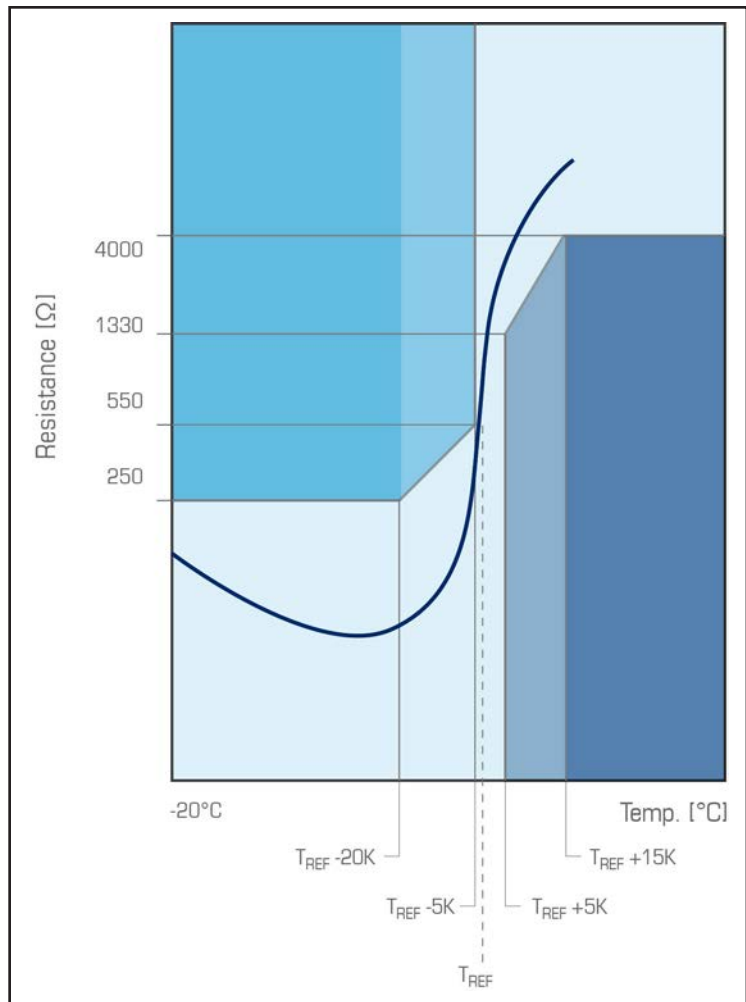

Figure 3 SNM sensors are typically used in low-voltage circuits.

Motors family	Temperature sensor configuration	Temperature sensor wiring
TMB TML TMM TMK	Configuration 8 (TMB...#8#-##) (TML...#8#-##) (TMM...#8#-##) (TMK...#8#-##)	
	Configuration H (TMB...#H#-##) (TML...#H#-##) (TMM...#H#-##) (TMK...#H#-##)	

Figure 4 There are two kinds of standard temperature configuration ETEL utilizes for its torque motors.

urations, all three phases are monitored (Fig. 5). Not all motors have this set-up because it is assumed that any overheating in one phase would be evenly replicated in the others. One scenario where this wouldn't apply would be under stall conditions. In a machine tool duty cycle—where torque motors are commonly used—there may be an instance where a part is held in place for a certain amount of time and the current isn't evenly distributed amongst all the phases; this is called a "stall condition." If one phase is found to be above an acceptable level and it's not the one that has a sensor on it, then a user runs the risk of a phase overheating without the driver even being aware of it. This is

why monitoring all phases is important. **Performance reduction.** Usually, when a project is in its prototyping stages, not all of the demands of the applications are fully known. Therefore when the time comes to select a motor, sometimes an option that has more power than what is necessary for the application is selected. This is usually done in order to allow room for any unexpected forces that would cause the motor to overheat. Along with that, the motor could be restricted from going past a certain temperature that is well below its maximum, or not be allowed to reach its listed average current value. Since there is a delay in the KTY sensor output, these measures are put in

place to anticipate overheating before the motor is damaged. The downside of these limitations is that the motor is unable to reach its full potential and in fact could be larger than what is necessary.

Depending on how over-sized the motor is, it may turn out that another smaller, less-expensive motor is up to the same task. Indeed—it could be discovered that by letting a motor reach values closer to its limit, a replacement can be chosen and end up saving a customer money in the long run.

**IMTHP.** In order to eliminate a lot of the safety measures that would limit the potential of a selected motor, Etel developed the IMTHP. The IMTHP is a thermal module developed for torque motors that employs the inputs of the three KTY sensors and thus creates a corrected analog temperature signal—providing the user a precise and continuous monitoring of actual motor temperature. It then takes these readings and uses its own algorithms to determine if the temperature is on-track to reaching an overheating point by outputting a simple digital warning/error signal that can be used without complex data processing on the controllers' part, and have the machine properly react if any problem is ever detected. In this way the delay in the KTY sensor reading was overcome so that a generally more accurate and precise temperature reading could be monitored. The IMTHP also provides galvanic insulation to protect the machine cabinet in case of a critical overvoltage defect (Fig. 6).

Overall, the greatest advantage of the IMTHP is that it allows the user to eliminate many of the previously mentioned safety measures (limiting the current and operating temperature, etc.) and run the motor at its full potential with minimal over-sizing.

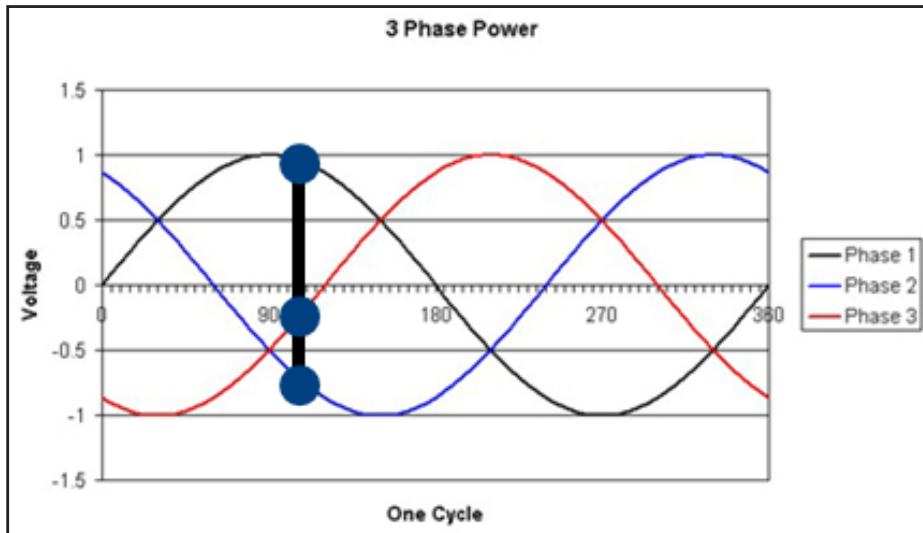

Figure 5 It is important to note that in each of the different configurations, all three phases are monitored.

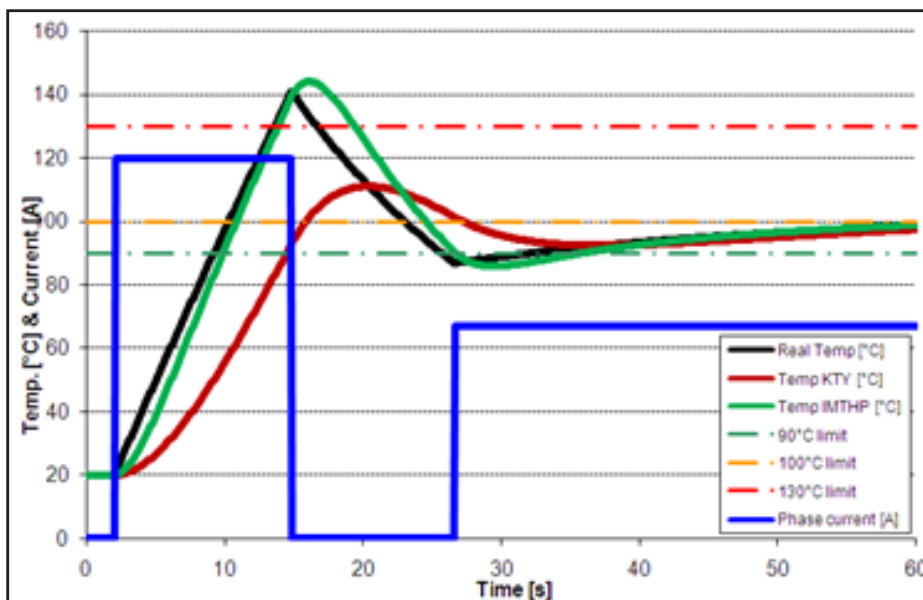

Figure 6 ETEL developed the IMTHP to eliminate the need for many of the safety measures that would limit the potential of a selected motor.

For Related Articles Search  
 torque motors  
 at www.powertransmission.com

## Conclusion

Multiple temperature monitoring methods have been discussed here — both physical and programmed; each serves to prevent motor overheating and damage. As anyone purchasing a machine would know, having an important element of the machine break that leads to an even wider systemic problem is a nightmare for anyone who relies on continuous operations. Acutely aware of these potential issues, Etel has not only fine-tuned these methods for their own products, but has also developed new methods — such as the IMTHP — to provide an extra degree of protection. Having everything fine-tuned not only keeps the motor, and, as a result, the machine's *operations*, fully functioning. It also allows the user's product to perform at its peak. This comprehensive fault check ensures the best efficiencies possible and a generally high-quality machine. **PTE**

### For more information:

Heidenhain Corporation / Etel Motors  
Brian Zlotorzycski  
333 E. State Parkway  
Schaumburg, IL 60173  
Phone: (847) 755-5569  
[bzlotorzycski@heidenhain.com](mailto:bzlotorzycski@heidenhain.com)  
[www.etel.ch](http://www.etel.ch)

As a product specialist for ETET Motors (a Heidenhain company), **Brian Zlotorzycski** is responsible for the North American sales and marketing of ETET's Swiss-manufactured products — specifically ETET linear and torque motor product support. Zlotorzycski is especially adept at providing solutions for industrial motor applications — particularly those requiring high torque/force.



# COBO HALL

DETROIT, MICHIGAN

October 20 & 21, 2015

## Power Transmission Engineering

Come to booth #2030 during Gear Expo to get your gear-related questions answered, live and in-person, by our panel of experts:

### GEAR GRINDING — Tuesday, 10/20 — 10:30 a.m.

- Dr. Hermann J. Stadtfeld, Gleason Corporation, VP Bevel Gear Technology/R&D
- Dr.-Ing Andreas Mehr, Liebherr, Technology Development, Grinding and Shaping
- Enrico Landi, Machine Tools Product Center Director, Samputensili, Star-SU
- Harald Gehlen, Head of Application Engineering, Reishauer

### CUTTING TOOLS — Tuesday, 10/20 — 2:00 p.m.

- Dr.-Ing. Nicklas Bylund, Sandvik Coromant, Manager Engineering Competence Center
- Dr. Hermann J. Stadtfeld, Gleason Corporation, VP Bevel Gear Technology/R&D
- John O'Neil, Engineering Manager for Gear Cutting Tools, Star SU

### GEAR DESIGN — Wednesday, 10/21 — 10:30 a.m.

- Prof. Dr.-Ing. Karsten Stahl, Technical University of Munich, Head of the Gear Research Center (FZG)
- Frank Uherek, Rexnord, Principal Engineer, Gear Engineering Software Development
- Dr. Hartmuth Müller, Klingelberg, Chief Technical Officer

### ASK ANYTHING — Wednesday, 10/21 — 2:00 p.m.

- Prof. Dr.-Ing. Karsten Stahl, Technical University of Munich, Head of the Gear Research Center (FZG)
- Dr. Hartmuth Müller, Klingelberg, Chief Technical Officer
- Chuck Schultz, Principal, Beyta Gear Service

Have a question? Send it in advance to [jmcguinn@geartechnology.com](mailto:jmcguinn@geartechnology.com)

ASK-THE-EXPERT

# Effects of Contact Ratios on Mesh Stiffness of Helical Gears for Lower Noise Design

Lan Liu, Yunfei Ding, Liyan Wu and Geng Liu

In this paper, the influences of various gear parameters on the mesh stiffness are systematically investigated by using the finite element method. The comprehensive analysis shows that contact ratios are the key factors affecting the fluctuation value of mesh stiffness.

## Introduction

Gear transmission has been widely used in mechanical equipment as one of the most important transmission modes. The vibration and noise of gears is directly related to the whole characteristics of the transmission system. In order to improve the performance and reduce the noise of gear transmission system, more attention should be paid to the gear dynamics. The fluctuation of mesh stiffness is one of the most important internal excitations of gear transmission, so it is crucial issue to find the influence factors of mesh stiffness fluctuation (Ref. 1). Many scholars have performed a lot of work to investigate the mesh stiffness for general gears using theoretical and experimental methods (Refs. 2-5). The main result told that when the contact ratio is an integer that the stiffness is approximately constant, which has a low effect on the dynamic characteristics (Ref. 4). Liu (Ref. 6) and Bu (Ref. 7) discussed the influence of design parameters such as helix angle, pressure angle, tooth face width, etc. on the mesh stiffness. Related research focused on the relationship between mesh stiffness and gears basic parameters, which were not involved how to adjust the parameters to reduce the mesh stiffness fluctuations and achieve a lower noise level.

In this paper, the mesh stiffness and its fluctuation value of helical gears with different parameters are calculated respectively by using the finite element method. The gear parameters concerned include pressure angle, helical angle, ad-

dendum coefficient and face width and etc.. Since the mesh stiffness fluctuation is closely related to the loads variation on the contact lines, the model for solving the mean length, total length and time-varying length of contact lines is also established. Then the influences of various gear parameters on the mesh stiffness are systematically investigated. The comprehensive analysis of the mesh stiffness shows that contact ratios are the key factors affecting the fluctuation value of mesh stiffness when the gear parameters are changed. By optimizing the basic parameters of helical gears, the fluctuation of the mesh stiffness of helical gears can be reduced.

## Method for Calculating Mesh Stiffness

A modified method for determining the time-varying mesh stiffness and actual load distribution based on linear programming is used in this research referring to the literature (Ref. 8). Using *Pro/E* software, a 3-D model of gear with true involutes profile was established based on the gear manufacturing technology firstly. Then the flexibility coefficient matrix of gear tooth surface was obtained using the substructure method by *ANSYS* software. Finally the time-varying meshing stiffness was solved by using linear programming method. The 3-D geometry and finite element models are presented in Figure 1. The advantage of this method is that the whole process is parameterized. In this method, the load

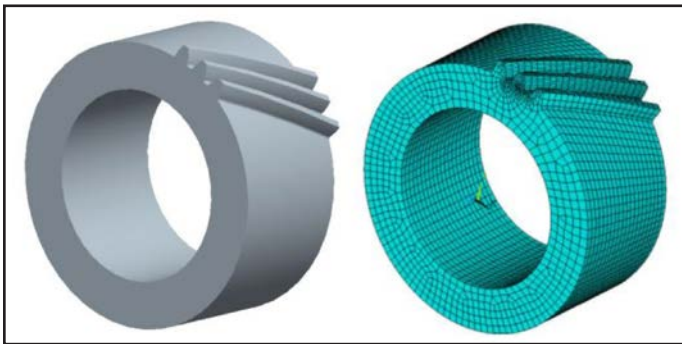

Figure 1 3-D and finite element models of helical gear.

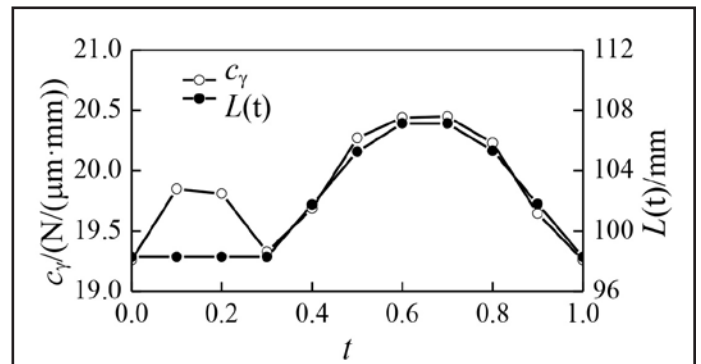

Figure 2 Time-varying mesh stiffness in a mesh period.

This paper was originally presented at the 2014 International Gear Conference, Lyon Villeurbanne, France and is republished here with the authors' permission.



distribution along the contact lines and mesh stiffness during the whole meshing period can be evaluated simultaneously.

Figure 2 shows the time-varying mesh stiffness in a mesh period calculating by the finite element method mentioned above. The  $x$  coordinate  $t$  means dimensionless time which is the mesh time divided by one mesh period. The  $y$  coordinate  $c_\gamma$  and  $L(t)$  are the time-varying mesh stiffness and the time-varying contact-line length respectively. The meshing stiffness decreases at the instantaneous position where the teeth enter contact or exit contact.

In order to study the laws of mesh stiffness, its fluctuation  $\eta_{c_\gamma}$  is defined as follows:

$$\eta_{c_\gamma} = \frac{\Delta c_\gamma}{c_{\gamma m}} \times 100\% \quad (1)$$

where  $c_{\gamma m}$  is the mean value of the time-varying mesh stiffness in one whole mesh period. The symbol  $\Delta c_\gamma$  is the difference value between the maximum value  $c_{\gamma max}$  and minimum value  $c_{\gamma min}$  of the time-varying mesh stiffness, i.e.  $-\Delta c_\gamma = c_{\gamma max} - c_{\gamma min}$ .

### Fluctuation of Contact-Line Length

Figure 3 shows the action plane of a pair of helical gears and the contact lines at different meshing times. Gear teeth begin to meshing from  $A$  position and out of meshing at  $C$  position. The line  $AD$  represents the actual action line, and line  $CD$  means the tooth face width  $B$ , where  $\varepsilon_\alpha$  and  $\varepsilon_\beta$ , being the transverse contact ratio and overlap contact ratio, respectively, and  $p_{bt}$  and  $p_{ba}$  being the transverse base pitch and axle base pitch, respectively.  $\beta_b$  is the base helix angle.

The formulas of contact-line length are derived based on Figure 3, which include the time-varying total contact-line length within the action plane  $L(t)$ , the mean value of the total contact-line length  $L_m$ , the maximum value  $L_{max}$ , and minimum value  $L_{min}$ . Here we define  $E_\alpha$  and  $E_\beta$  as representing the integer part of  $\varepsilon_\alpha$  and  $\varepsilon_\beta$ , while we define  $e_\alpha$  and  $e_\beta$  as representing the decimal part of  $\varepsilon_\alpha$  and  $\varepsilon_\beta$  respectively.

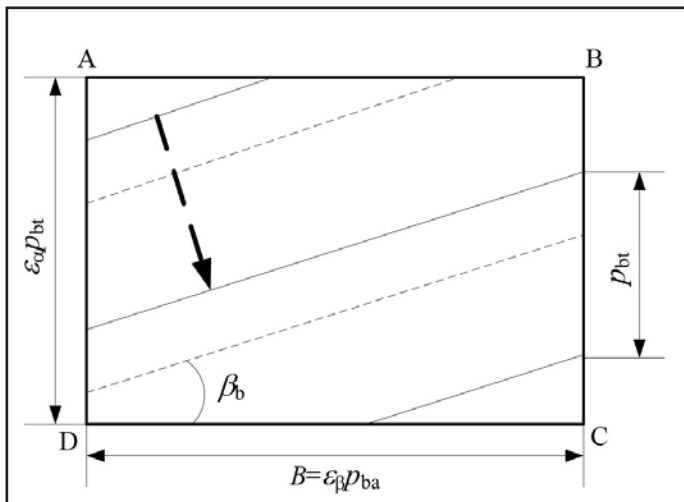

Figure 3 Action plane and contact lines.

If  $e_\alpha + e_\beta \leq 1$ , the time-varying length  $L(t)$  can be expressed as:

$$L(t) = L_1 + \begin{cases} \frac{p_{ba}}{\cos \beta_b} t & 0 \leq t < e_1 \\ \frac{p_{ba} e_1}{\cos \beta_b} & e_1 \leq t \leq e_2 \\ \frac{p_{ba}}{\cos \beta_b} (-t + e_1 + e_2) & e_2 < t \leq e_1 + e_2 \\ 0 & e_1 + e_2 < t \leq 1 \end{cases} \quad (2)$$

While,  $e_\alpha + e_\beta > 1$ :

$$L(t) = L_1 + \begin{cases} \frac{p_{ba}}{\cos \beta_b} (e_1 + e_2 - 1) & 0 \leq t < e_1 + e_2 - 1 \\ \frac{p_{ba}}{\cos \beta_b} t & e_1 + e_2 - 1 \leq t \leq e_1 \\ \frac{p_{ba} e_1}{\cos \beta_b} & e_1 < t \leq e_2 \\ \frac{p_{ba}}{\cos \beta_b} (-t + e_1 + e_2) & e_2 < t \leq 1 \end{cases} \quad (3)$$

Where:  $L_1 = E_\alpha E_\beta l_1(t) + E_\beta l_2(t) + E_\alpha l_3(t)$ ,  $l_1(t) = p_{ba} / \cos \beta_b$ ,  $l_2(t) = p_{ba} e_\alpha / \cos \beta_b$ ,  $l_3(t) = p_{ba} e_\beta / \cos \beta_b$ ,  $e_1 = \min(e_\alpha, e_\beta)$  and  $e_2 = \max(e_\alpha, e_\beta)$ .

The mean value  $L_m$  of the contact-line length can be given by:

$$L_m = \frac{\varepsilon_\alpha B}{\cos \beta_b} = \frac{\varepsilon_\alpha \varepsilon_\beta p_{ba}}{\cos \beta_b} \quad (4)$$

According to Equations 2 and 3, the maximum value  $L_{max}$  of the contact-line length can be derived as:

$$L_{min} = \frac{(\varepsilon_\alpha \varepsilon_\beta - e_\alpha e_\beta + e_1) p_{ba}}{\cos \beta_b}$$

When  $e_\alpha + e_\beta \leq 1$ , the minimum value  $L_{min}$  of the contact-line length can be expressed as:

$$L_{min} = \frac{(\varepsilon_\alpha \varepsilon_\beta - e_\alpha e_\beta) p_{ba}}{\cos \beta_b} \quad (6)$$

while  $e_\alpha + e_\beta > 1$ , the minimum value  $L_{min}$  of the contact-line length can be expressed as:

$$L_{min} = \frac{(\varepsilon_\alpha \varepsilon_\beta - e_\alpha e_\beta + e_\alpha + e_\beta - 1) p_{ba}}{\cos \beta_b} \quad (7)$$

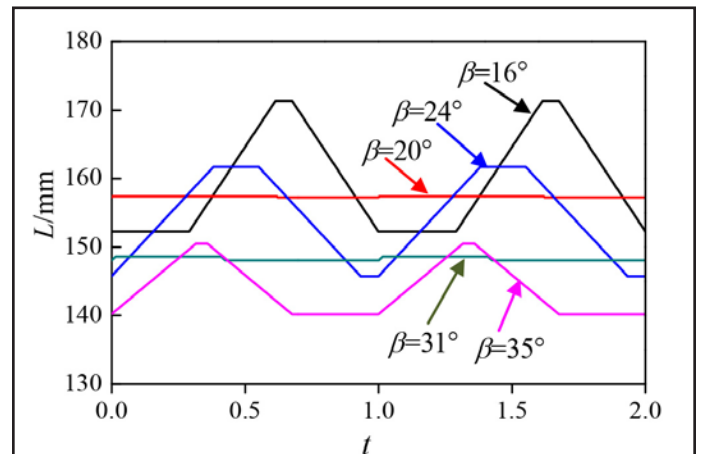

Figure 4 Lengths of contact lines vs. different helix angles  $\beta$ .

In order to measure the fluctuation of contact-line length during one whole meshing period, the changing ratio of the total length of contact lines  $\eta_L$ , defined as the relative difference between the maximum value  $L_{max}$  and the minimum value  $L_{min}$  to the mean value  $L_m$  of the total length of contact lines. The formula of  $\eta_L$  is expressed as:

$$\eta_L = \frac{L_{max} - L_{min}}{L_m} \times 100\% \tag{8}$$

On the basis of Equations 4-7,  $\eta_L$  can also be expressed as:

$$\eta_L = \begin{cases} \frac{e_1}{\varepsilon_\alpha \varepsilon_\beta} \times 100\% & \varepsilon_\alpha + \varepsilon_\beta \leq 1 \\ \frac{1 - e_2}{\varepsilon_\alpha \varepsilon_\beta} \times 100\% & \varepsilon_\alpha + \varepsilon_\beta > 1 \end{cases} \tag{9}$$

Figure 4 shows the effects of helix angle  $\beta$  on the time-varying contact lines. Table 1 displays the initial parameters of the helical gears that are discussed in Figure 5. The helix angle  $\beta$  is varied from  $16^\circ - 35^\circ$ . It is seen that the variation of curves has the same trend — but with different amplitudes. Comparing contact ratios at different helix angles, as seen in Table 2,

parameter	z	$m_n/mm$	$\alpha_n/^\circ$	$\beta/^\circ$	$h_{an}$	$c_n$	B/mm	x
pinion	37	5	20	16~35	1.0	0.25	92	0
gear	106	5	20	16~35	1.0	0.25	92	0

$\beta/^\circ$	$\varepsilon_\alpha$	$\varepsilon_\beta$	$\varepsilon_\gamma$
16	1.6760	1.6411	3.2904
20	1.6197	2.0032	3.6229
24	1.5523	2.3822	3.9346
31	1.4104	3.0165	4.4269
35	1.3175	3.3594	4.6769

it is found that when the overlap contact ratio of a helical gear is close to an integer, such as when  $\beta$  is  $20^\circ$  or is  $31^\circ$ , the amplitude of  $L(t)$  is very low, and the changing ratio of the total length of contact lines  $\eta_L$  is approximate to zero.

In order to reveal the rules of the length of contact lines, considering the general conditions, the surface chart about the changing ratio of the total length of contact lines  $\eta_L$  vs. different transverse contact ratios and overlap contact ratios is plotted in Figure 5; this curved surface chart is obtained by the Equation 9.

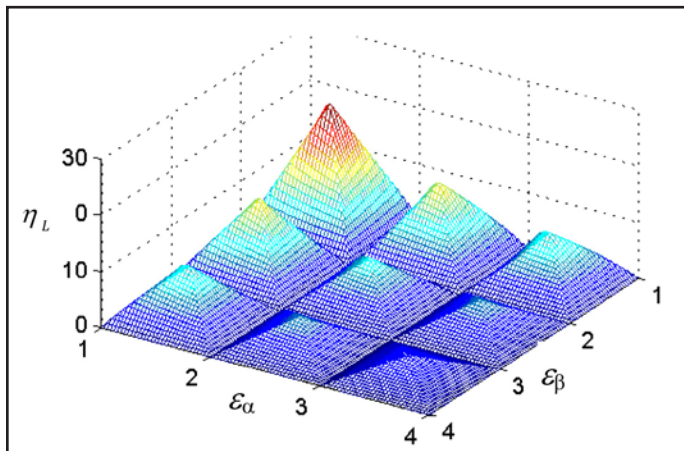

Figure 5 The surface chart of  $\eta_L$  vs. contact ratios.

From Figure 5 the influences of contact ratios, including transverse contact ratio, overlap contact ratio and total contact ratio to the length of contact line are exhibited. The results show that contact ratios are the key factor affecting the fluctuation value of contact-line length. The fluctuation value of  $\eta_L$  has an extreme maximum when the total contact ratio is an integer, while it has a minimum, i.e. — zero — when the transverse contact ratio or face contact ratio is an integer.

### The Influential Factors of Mesh Stiffness

In order to discuss the influential factors of mesh stiffness and its fluctuation, a series of mean values of the time-varying mesh stiffness  $c_{ym}$  and their fluctuation values  $\eta_{c_y}$ , mean values of contact-line length  $L_m$  and their changing ratios  $\eta_L$  of helical gears with different parameters were solved, respectively, using the method mentioned above.

**Helix angle.** Figure 6 shows the effect of helix angle  $\beta$  on the mean value of mesh stiffness  $c_{ym}$  and contact-line length  $L_m$ . The helix angle  $\beta$  is varied from  $14^\circ - 42^\circ$ . It is seen that the mean values of mesh stiffness and lengths of contact lines decrease in the same trend while helix angle  $\beta$  increases.

Figure 7 shows that the changing ratio of the total length of contact lines  $\eta_L$  and mesh stiffness  $\eta_{c_y}$  change with the contact ratios when helix angle  $\beta$  increases. The overlap contact ratio is varied from 1.41–3.91, while the total contact ratio varying from 3.11–5.06 when  $\beta$  increased from  $14^\circ - 42^\circ$ . It is seen that mesh stiffness and lengths of contact lines have the same trend, while helix angle  $\beta$  or contact ratios increase.

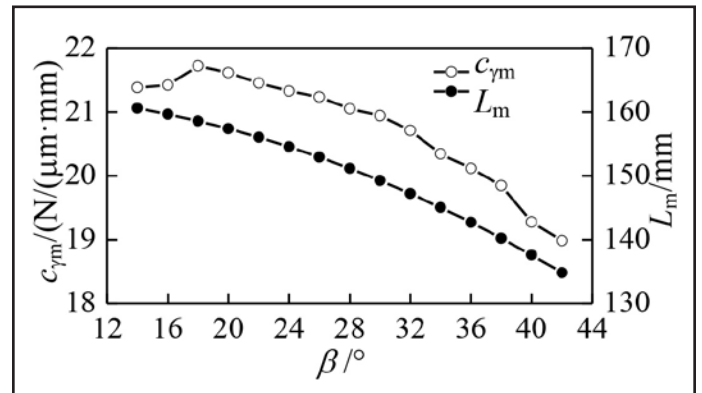

Figure 6 The  $c_{ym}$  and  $L_m$  vs. different helix angles  $\beta$ .

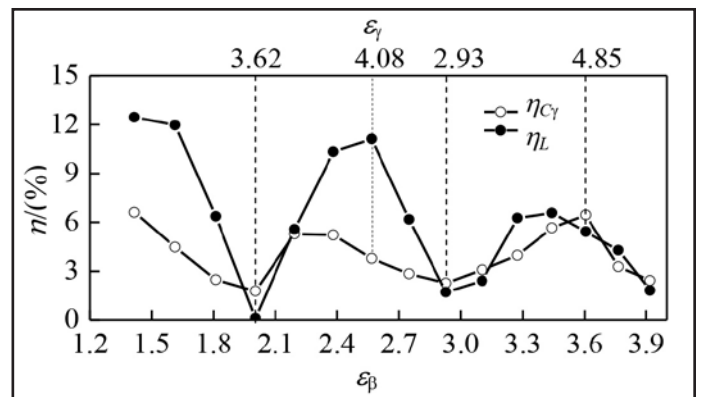

Figure 7 The  $\eta_{c_y}$  and  $\eta_L$  vs. helix angle and contact ratios.

The graph shows that the minimum value of  $\eta_{c\gamma}$ , as well as  $\eta_L$ , appears when the overlap contact ratio is close to an integer. However the maximum value of  $\eta_{c\gamma}$  and  $\eta_L$  appears when the total contact ratio is close to an integer.

**Addendum coefficient.** Figure 8 shows the effect of addendum coefficient  $h_{an}$  on the mean value of mesh stiffness  $c_{\gamma m}$  and contact-line length  $L_m$ ; the addendum coefficient  $h_{an}$  is varied from 0.4–1.4. It is seen that the mean values of mesh stiffness and lengths of contact lines increase in the same trend when addendum coefficient  $h_{an}$  increases. The increasing values of  $L_m$  and  $c_{\gamma m}$  are 144 mm and 8.37 N/( $\mu\text{m}\cdot\text{mm}$ ), respectively.

Figure 9 shows the changing ratio of the total length of contact lines  $\eta_L$  and mesh stiffness  $\eta_{c\gamma}$  change with the contact ratios when addendum coefficient  $h_{an}$  increases. The transverse contact ratio is varied from 0.63–2.05, while the overlap contact ratio remains unchanged, and the total contact ratio varying from 3.26–4.68 when  $h_{an}$  increases from 0.4–1.4. The graph shows that the minimum value of  $\eta_{c\gamma}$ , as well as  $\eta_L$ , appear when the transverse contact ratio is close to integer, which is 1 or 2 here. However, the maximum value of  $\eta_{c\gamma}$  and  $\eta_L$  appears when the total contact ratio is close to integer 4.

**Tooth face width.** Figure 10 shows the effect of tooth face width on the mean value of mesh stiffness  $c_{\gamma m}$  and contact-line length  $L_m$ . The face width  $B$  is varied from 52 mm–118 mm. It is seen that  $c_{\gamma m}$  and  $L_m$  increase in the same trend when the face width  $B$  increases. The increasing values of  $L_m$  and  $c_{\gamma m}$  are 109 mm and 3.19 N/( $\mu\text{m}\cdot\text{mm}$ ), respectively.

The results of  $\eta_{c\gamma}$  and  $\eta_L$  by varying the tooth face width  $B$  from 52mm to 118mm, are plotted in Figure 11, which shows that  $\eta_L$  and  $\eta_{c\gamma}$  change with the contact ratios when face width  $B$  increases. The overlap contact ratio is varied from 1.48–3.37

while the transverse contact ratio remains the same, and the total contact ratio varying from 2.99–4.87.

The graph shows that the minimum value of  $\eta_{c\gamma}$ —as well as  $\eta_L$ —appears when the overlap contact ratio is close to an integer—2 or 3 in this case. But the maximum value of  $\eta_{c\gamma}$  and  $\eta_L$  appears when the total contact ratio is close to integer 4.

**Pressure angle.** Figure 12 shows the effect of gear pressure angle  $\alpha_n$  on the mean value of mesh stiffness  $c_{\gamma m}$  and contact-line length  $L_m$ . The pressure angle  $\alpha_n$  is varied from 16°–26°. It is seen that the mean values of mesh stiffness and lengths of contact lines decrease in the same trend when pressure angle  $\alpha_n$  increases. The decreasing values of  $L_m$  and  $c_{\gamma m}$  are 46.98mm and 1.41N/( $\mu\text{m}\cdot\text{mm}$ ), respectively.

The results of  $\eta_{c\gamma}$  and  $\eta_L$  by varying the pressure angle  $\alpha_n$  from 16° to 26° are plotted in Figure 13, which shows that  $\eta_L$  and  $\eta_{c\gamma}$  change with the contact ratios when pressure angle  $\alpha_n$  increases. The transverse contact ratio is varied from 1.73–1.29, while the overlap contact ratio is unchanged, and the total contact ratio varying from 4.36–3.92.

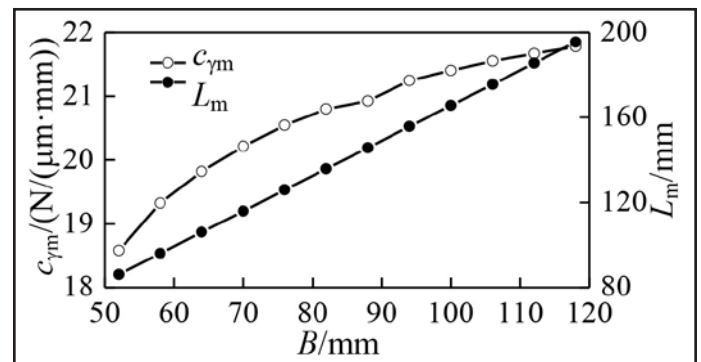

Figure 10 The  $c_{\gamma m}$  and  $L_m$  vs. different face width  $B$ .

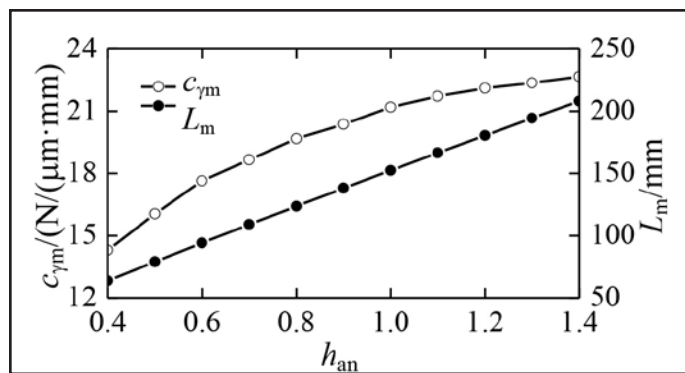

Figure 8 The  $c_{\gamma m}$  and  $L_m$  vs. different addendum coefficient  $h_{an}$ .

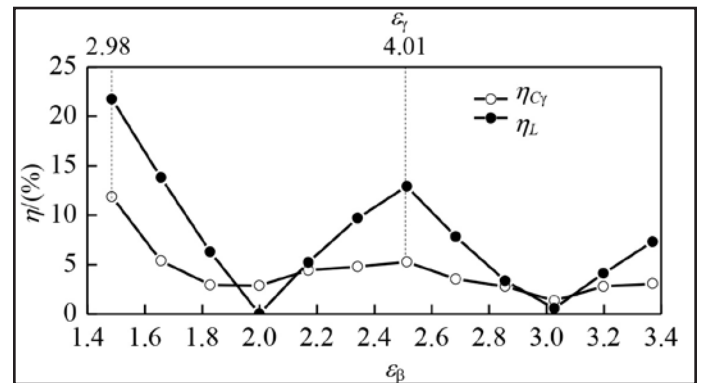

Figure 11 The  $\eta_{c\gamma}$  and  $\eta_L$  vs. face width and contact ratios.

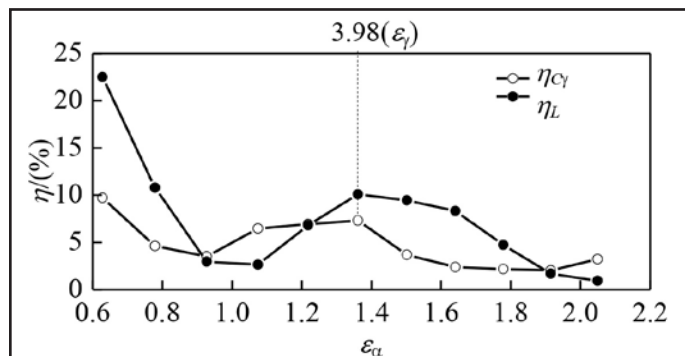

Figure 9 The  $\eta_{c\gamma}$  and  $\eta_L$  vs. addendum coefficient and contact ratios.

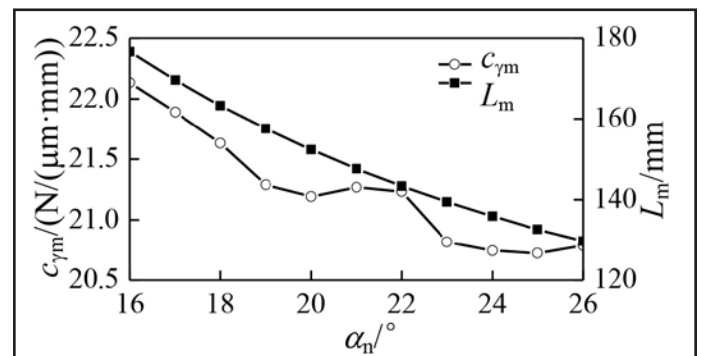

Figure 12 The  $c_{\gamma m}$  and  $L_m$  vs. different pressure angle  $\alpha_n$ .

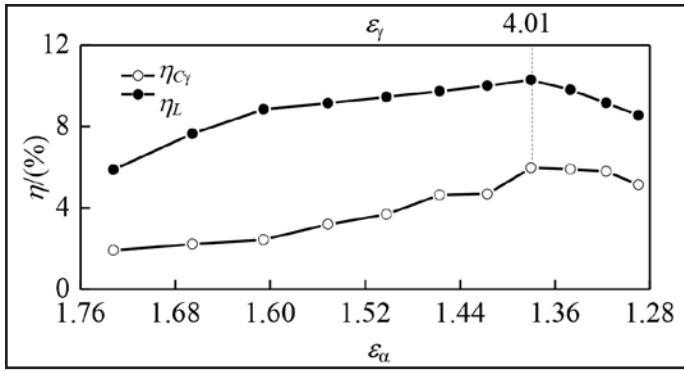

Figure 13 The  $\eta_{cr}$  and  $\eta_L$  vs. pressure angle and contact ratios.

Here the graph doesn't show that the minimum value of  $\eta_{cr}$  or  $\eta_L$  appears when the overlap contact ratio is an integer because of the pressure angle range. However, the maximum value of  $\eta_{cr}$  and  $\eta_L$  appears when the total contact ratio is close to integer 4. Regardless of calculating errors, the trend of  $\eta_{cr}$  is completely the same as  $\eta_L$ .

### Conclusions

In this paper the mesh stiffness and its fluctuation value of helical gears with different parameters, respectively, are calculated by using the finite element method. The influences of various gear parameters on the mesh stiffness are systematically investigated. The gear parameters concerned here include pressure angle, helical angle, addendum, co-efficient, face width, etc. The comprehensive analysis of the mesh stiffness shows that contact ratios are the key factors affecting the fluctuation value of mesh stiffness when the gear parameters are changed. The fluctuation value of mesh stiffness attains a minimum when the transverse contact ratio or overlap ratio is close to an integer, while it has an extreme maximum when the total contact ratio is approximate to an integer.

Since mesh stiffness fluctuation is closely related to the load variations on the contact lines, the model for solving the mean length, total length and time-varying length of contact lines is also established. By calculating the length of contact lines of various helical gear pairs with different basic parameters, the results show that the total length of contact lines doesn't change when the transverse contact ratio or overlap ratio is an integer, while it fluctuates more intensively when the total contact ratio is indeed an integer.

In comparing the fluctuation amplitude of the total length of contact lines with the fluctuation amplitude of mesh stiffness, it is found that the fluctuation amplitudes of both contact lines and mesh stiffness have the same trend when gear parameters are changed. So it is proposed that the length and fluctuation value of contact line can be used to approximately measure the trend of mesh stiffness — but the values of mesh stiffness still need special calculation software.

According to the above discussion, it can be predicted that by optimizing the basic parameters of helical gears, the fluctuation of the mesh stiffness of helical gears can be reduced and the gear transmission system with appropriate contact ratios can achieve a lower vibration and noise level. **PTE**

**Acknowledgment.** This work is supported by the 111 project (Grant No.B13044) and the Engineering Research Center of Expressway Construction & Maintenance Equipment and Technology (Chang'an University), MOE (2013G1502057).

### References

1. Smith, J.D. *Gear Noise and Vibration*, Marcel Dekker, Inc., New York, 2003.
2. Umezawa, K., T. Suzuki and T. Sato. *Bulletin of JSME*, 29, 1605-1611, 1986.
3. Nagaya, K. and S. Uematsu. *Trans. ASME. J. Mech. Des.* 103, 357-363, 1981.
4. MacLennan, L.D. *J. Mechanical Engineering Science*, 216, 1005-1016, 2002.
5. Wang, J and I. Howard. *J. Mechanical Engineering Science*, 218, 131-142, 2004.
6. Liu, G. *Chinese Journal of Mechanical Engineering*, 27, 20-24, 1991.
7. Bu, Z.H., G. Liu and L. Y. Wu. *Journal of Aerospace Power (Chinese)*, 25, 957-962, 2010.
8. Bu, Z.H., G. Liu., L. Y. Wu and Z. M. Liu. *Mechanical Science and Technology for aerospace Engineering (Chinese)*, 27, 1365-1368, 2008.

**Lan Liu** received his PhD in mechanical engineering in 2007 at the Northwestern Polytechnical University of China, and then joined the University the following year as an associate professor of mechanical engineering. His current research interests include the dynamics and vibro-acoustics of gear system, advanced numerical simulation methods and bionic mechanics. Liu is now teaching theory of elasticity and finite element method.



**Yunfei Ding** was a postgraduate student in mechanical engineering when he as co-author for this paper. He has received his master degree in 2014 at the Northwestern Polytechnical University of China.



**Liyan Wu** is professor of mechanical engineering at the Northwestern Polytechnical University of China. His current research interests include the reliability techniques in machine design, control technology for vibration and noise in mechanical system and modern theories and methods in machine design.



**Geng Liu** is professor of mechanical engineering at Northwestern Polytechnical University of China. He holds a PhD in mechanical engineering since 1994 from Xian Jiaotong University of China. From 1997-1999, he has as visiting scholar and post-doctoral fellow studied in Florida International University and Northwestern University of USA respectively. His current research interests include contact mechanics, mechanical transmission and virtual and physical prototyping simulation of mechanical systems.



A wireframe funnel, resembling a time machine, is positioned in space. At the top of the funnel is a small Earth, and at the bottom is a larger Earth. The background is a vibrant red and black nebula with scattered white stars.

# **GREAT SCOTT!**

## ***It's the future!***

**OK, you blinked and missed last month's issue of *Power Transmission Engineering*.** Fortunately, you don't need a DeLorean to travel back in time — just a computer and working fingers.

Hop online and visit [www.powertransmission.com](http://www.powertransmission.com) to view the entire magazine, including these exclusive features:

- Getting a Piece of that Sweet Coupling Pie
- The Small Motor Rule — How Will it Affect You?
- Ask the Expert — Pre-tension Thrust Bearings
- Applications of Bevel Gears

**...and much more!**

[www.powertransmission.com](http://www.powertransmission.com)

# Global Industrial Outlook: Kind of Sluggish

Brian Langenberg

*We anticipate no substantive improvement in manufacturing activity.* Not in the U.S. or internationally. If anything, headwinds may have become slightly more pronounced because a U.S.—Iran “deal” that everybody hates except a) the Iranian government and b) the Obama administration will result in the release of Iranian oil supply back onto the global market. Oil had rallied from about \$50 to \$60 over the past month (I like round numbers), but has since round-tripped. Expect further, deeper capital spending cuts in the U.S. oil sector to continue affecting demand for large capital equipment.

*China’s stock market sell-off could be dangerous—but probably isn’t.* The bad news is off about 25%, and the institutional investment world is preparing to hyperventilate while throwing up charts comparing its stock markets to 1929. Except this is *not* 1929. The world remains in a global mode of austerity and caution—not ebullience. Monetary policy is loose and supportive of markets, whereas 1929 saw tightening. Further, the just-passed Trans Pacific Act (TPA) is the complete opposite of Smoot-Hawley trade protectionism.

*Still, the rest of the world is hardly doing great.* Greece is threatening to refuse to pay its debts unless Europe (READ: Germany) allows them to not pay their debts. If Greece leaves, it’s Greece’s problem. If Spain did that, it would be Europe’s problem. If you are a Spanish politician watching what is

going on in Greece, and you are not particularly stupid, you won’t try to emulate. Meanwhile, global industrial activity is stagnant at best.

## *May manufacturing activity:*

China	49.4
South Korea	46.1
Brazil	46.5
India	47.8

Bright spots remain global aerospace and automotive production—each benefitting from overall global economic growth and lower fuel prices.

## **Here is our updated outlook for key geographic regions and end markets:**

***U.S. remains the safe, modest growth bet.*** Weakness abounds in commodity related sectors—oil, coal and farm equipment—but fundamentals remain positive for non-residential construction, consumer durables (auto, housing) boosted by gradually improving employment. And of course that huge Boeing backlog is comforting to the whole aerospace supply chain, albeit Boeing is not fully comforted by the ability of its supply chain to deliver.

***Europe.*** I do not care about Greece. I do care about Germany, France, the Nordics (collectively) and Central/Eastern Europe. The weaker Euro benefits exports, while lower commodity prices and slowing China growth are headwinds. Life will go on. Modest growth will continue.

***Middle East.*** Not sure what the Iranian “deal” will do. My sense is nothing as Saudi Arabia can still print money at \$50/barrel or lower. Right now they are

investing to keep their mature fields working. Incremental growth in defense spending is likely.

***Latin America.*** Mexico continues to grow, and capital investment in the auto and aerospace sectors remains strong. Brazil, Argentina, much of the region seems set to remain in the tank along with lower commodity prices.

***China.*** Directly speaking, not a big market for heavy capital equipment shipments out of the U.S.; weak euro, strong dollar exacerbate the situation. Long-term I hope their government’s increased belligerence and the recent hack of U.S. government systems is waking up even the densest pockets of U.S. isolationism of either political party if not their constituents. Asia gets it. Japan is being pushed by the rest of the region to build its armed forces and Japan is changing its constitution to allow overseas war fighting.

***Oil & Gas.*** Assuming Iranian oil comes back into the global market, prices will be further pressured. We continue to see negative comps for the next 2-4 quarters before stabilizing at lower spending levels.

***Mining.*** Whole coal sector trading like it’s about to go under and JOY global results did not carve out much of a silver lining; bad news for CAT, JOY and others.

***Power generation.*** U.S. power generation remains weak, Band-Aid sales (wind turbines) continue strong. Those of you who supply GE on the gas turbine side should be concerned with the EU’s challenge of the Alstom-GE hook up because a) the deal could fall through entirely and b) the longer it drags, the longer commercial uncertainty can be used against GE in the marketplace. GE has stated they offered concessions. Stay tuned.

***Transportation infrastructure.*** More stability through 2016-2017, with perhaps modest growth. I remain convinced that lower oil prices will lessen



the growth profile for oil shipped by rail.

**Machinery.** Agriculture remains weak, as do cranes. Continue to see modest demand growth as lower energy related demand is offset by non-residential and residential construction.

**Consumer (auto, appliances).** Auto benefitting from old cars, improving employment and capital investment in Mexico. Residential construction growth should help appliances. Magically, not only is GE having a hard time closing on Alstom (power gen) but the U.S. DOJ is challenging the sale of GE Appliances to Electrolux!

**Aerospace/Defense.** Global commercial aircraft demand is rock solid driven by economic growth, low fuel prices and strong capital markets. Cargo is also picking up. Defense spending has troughed in the U.S. and international growth strikes us as likely though with little benefit to the U.S. industrial base.

**Focus Company: Boeing (BA)**

Pretty sure you already know they make airplanes, but we will spend a bit of time detailing the platforms, breadth, and growth opportunities, along with that *huge* backlog which ended 1Q15 at \$495 billion, i.e. — \$435B commercial, \$60B military.

**Unfilled orders (as of June) were 5,689 aircraft. A look by major platform:**

737 MAX	2,831
737-800	1,181
747	31
767	39
777	563
787	803



Boeing's 12-month stock performance.

The foreseeable future growth engines are 787 and 737. Boeing's No. 1 priority over the next 2-3 years is to ensure supply chain performance so they can capture margin on the huge backlog.

Longer-term current and potential suppliers to Boeing must focus on three things:

1. Long-term program decisions
2. Potential insourcing
3. Execution

The last is obvious; Boeing wants and needs to execute on their backlog and it is broadly believed the commercial aerospace supply chain is stretched to the limit. Meeting and exceeding their expectations would be a minimum hurdle for future programs, as existing suppliers already know.

We will be interested — and so should you — in how Boeing approaches ver-

tical integration in the coming years. When current CEO Jim McNerney, who is retiring, came in, he did what all GE executives do — drive the company with financial metrics and seek to minimize capital investment and outsource as much as possible to capture higher returns on capital. When the 787 was in development, as much R&D work as possible was pushed down to suppliers. Unfortunately the move proved “penny-wise, pound-foolish” and delays and problems drove an incremental reversal toward Boeing taking more ownership. With McNerney retiring and Dennis Muilenberg, a 30-year veteran and engineer, taking over, we anticipate a greater emphasis on “owning” the development and supply chain.

The key for component and systems manufacturers is that demand is strong and opportunities to position yourself for future programs exists, but the bar is high! **PTE**

**Special Offer:** PTE readers can subscribe to all our written research for a discounted rate of \$995 per year. You will receive, at a minimum, 20 Integrated Company Dashboards (ICDs) each quarter on major U.S. and European machinery manufacturers, aerospace engine producers and key industrial companies. You can also expect to receive analyses of major company events, think pieces and topical reports as they occur. We are also happy to accommodate bulk subscriptions at attractive rates.

These analyses are available on our website for \$199 but readers of *Power Transmission Engineering* magazine can email me directly at [Brian@Langenberg-llc.com](mailto:Brian@Langenberg-llc.com) and ask for a copy by putting “PTE Offer” in the subject line and the ticker for which company they want — choose 1 from: AME, CAT, DOV, EMR, HON, MMM, MTW, ROK, URI, or UTX.

**Market Research:** Let us help you map out your customer’s market development plans and manufacturing strategy to minimize risk and ensure you are aware of all opportunities for growth.

**Brian K. Langenberg, CFA,** has been recognized as a member of the Institutional Investor All-America Research Team, a *Wall Street Journal* All-Star, and *Forbes*/*Starmine* (#1 earnings estimator for industrials). Langenberg speaks and meets regularly with CEOs and senior executives of companies with over \$1 trillion in global revenue. His team publishes the *Quarterly Earnings Monitor/Survey* — gathering intelligence and global insight to support decision-making. You can reach him at [Brian@Langenberg-llc.com](mailto:Brian@Langenberg-llc.com) or his website at [www.Langenberg-LLC.com](http://www.Langenberg-LLC.com).



# Baby Steps in Wind Energy

ALEX CANNELLA

The Department of Energy estimates that 4 million megawatts of potential power—four times the amount all U.S. power plants combined currently produce—exists in offshore wind energy. Construction of America's first offshore wind turbines began in July. The wind farm, which is being constructed off the coast of Block Island, RI, will consist of five turbines. Together, they will produce 30 MW.

It's not even a drop in the bucket. But it's a start, and may mark the beginning of a sea change in public opinion on offshore wind energy.

The idea of offshore wind turbines has always been a contentious issue in the United States. There's no question that all that extra, clean energy would be a boon to the country. Wind turbines sound great

on paper, but the voice for change suddenly gets caught in people's throats once they realize those turbines are coming to a coast near them. Between the noise and the towers of metal spoiling otherwise unbroken ocean views, complaints start arising once people start to realize that to make the ideal reality, there will be changes to their personal lives.

Even at Block Island, there's some degree of "Not in my Back Yard" syndrome going on. Despite that, however, developer Deepwater Wind's project has been pushed through with surprising ease, unlike past attempts elsewhere.

So what's different here? For one thing, the turbines will be placed three miles away from Block Island and 12 miles off mainland Rhode Island's coast. It's predicted that the turbines won't even be visible from the mainland. Block Island is also suffering from crippling electricity costs—50 cents per kilowatt-hour—and just those five turbines are predicted to reduce electricity residents' bills by 40 percent. In the face of those savings, the ocean view sounds like a small price to pay.

While the scale is small, Block Island's turbines might lay down a precedent for future, larger-scale operations as a proof of concept. Even as Deepwater Wind con-



tinues construction, however, the gears are already starting to turn. The government has awarded nine separate leases for offshore wind projects. Deepwater Wind has another two projects planned off the northeast coast, both for wind farms 200 turbines strong. The DoE's report, *20 Percent Wind Energy by 2030* (which, as the name might suggest, is a plan to provide wind energy to 20 percent of America's residents), calls for 54 GW of offshore wind power alongside another 251 GW of land-based wind energy.

Utilizing all 4 million megawatts of potential power would be a tall order. To put that figure in perspective, the American Wind Energy Association reports that the total U.S. installed capacity (at the end of 2014) was about 66 GW. The European Wind Energy Association reports that nearly 130 GW has been installed in the European Union to date. Even China, the world leader in wind energy, only had an installed base of 114 GW (1.14 million megawatts) at the end of 2014, and all of those figures include turbines on land.

It would take a Herculean amount of time, funds and effort, more than is likely feasible, to wring every potential watt of energy possible from the wind. More reasonable plans like the one laid out in the DoE's report likely won't be easy, either. But Block Island is in a position to settle the debate of whether it's worth it or not. **PTE**



## ROD ENDS & SPHERICAL BEARINGS FOR EVERY PROJECT



QA1 has what you need for your application with inch and metric rod ends and spherical bearings that feature precise tolerances to ensure quality, consistency and durability. Choose from a variety of construction styles, materials and sizes from QA1's huge inventory with over 99% same day shipping.

ISO 9001:2008 CERTIFIED  
SALES@QA1.NET  
QA1.NET/INDUSTRIAL  
P: 800.721.7761 F: 952.985.5679



**SUHNER**

Transmission expert.

SUHNER

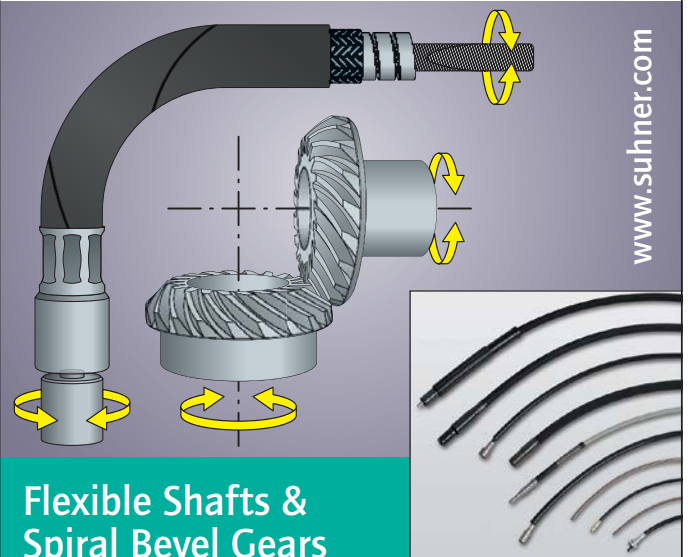

www.suhner.com

## Flexible Shafts & Spiral Bevel Gears

Two different ways to transmit rotary motion.

**SUHNER**

SUHNER Manufacturing Inc. · Rome, GA 30161  
Phone: 706-235-8046 · info.usa@suhner.com



## Emerson

DELIVERS UPGRADE AT CHAMPAGNE PRODUCER  
NICOLAS FEUILLATTE

Emerson Motors and Drives recently improved the drive system for The Centre Vinicole Champagne Nicolas Feuillatte (CV-CNF). CV-CNF is comprised of 80 cooperatives and represents over 5,000 wine-growers. Its facility in Chouilly, France, in the Marne region, is one of the most automated plants of its type, with a workforce of 235 people, half of whom are involved in production. The company output reaches 23 million bottles a year, making it one of the world's leading champagne producers.



“We needed to replace a series of drive systems, in a gradual process,” said Frédéric Lopez, automation manager at CV-CNF. “We considered using the original supplier of the equipment, as well other leading firms in this sector. They were all able to supply equipment that would have met our expectations, but we also wanted to establish a partnership with a company able to deliver the level of service we needed. This is why we selected Emerson.”

The existing drive system consisted of an automatic controller, an alignment controller, a variable speed drive and a motor. The solution from Emerson removes the need for the alignment controller, reducing the overall complexity of the system. It consists of a Control Techniques Unidrive M700 variable speed drive, connected to the automatic controller and combined with a Leroy-Somer DYNABLOC Pjn1102 low backlash servo-gear. This offers high overload tolerance, very high torsion strength and improved accuracy. Emerson's MCi200 machine control option module has been added to Unidrive M to manage positioning.

The Unidrive M700 drive is suited to this type of application, with a cycle time of 250µs, synchronised communications through real-time Ethernet and an integrated PLC for controlling movement sequences.

The entire application is simple to program using Engineering Control Studio. The system uses Unidrive M's embedded Advanced Motion Controller. In the final configuration, 15 different configurations have been defined to suit the various bottle shapes. Each cycle has a coarse pitch with a specific movement profile (position, speed, acceleration and deceleration), a fine pitch with a second movement profile (position, speed, acceleration and deceleration) and the number of short pitches to be carried out. The required configuration is selected using logic inputs, which automatically starts the chosen cycle.

The coarse pitch is performed then the fine pitches are chained together while the path is free. Signals for 'end of long movement' and 'cycle completed' are sent by the drive's logic outputs to the client system. All programming and training was carried out on site by Emerson's support teams.

“We have taken over the application completely so that we can make our own adaptations,” Lopez said. “With its technologies, expertise, and service, Emerson has fully met our expectations and we are in the process of deploying their solutions across our entire site.”

## Romax

SECURES CONDITION MONITORING SERVICES AGREEMENT  
WITH MYTRAH ENERGY

Romax Technology Ltd. recently secured an agreement to provide condition monitoring services for India's largest independent power producer, Mytrah Energy Ltd., including end of warranty inspection services for 32 x 2MW wind turbines, from sites in Rajasthan and Gujarat, India.

Romax's condition monitoring software tools and predictive maintenance services provide wind farm owners and operators with diagnostic and prognostic intelligence to facilitate predictive maintenance regimes.

Spread across six states, with over 380 wind turbines in India, Mytrah Energy was entering the final stages of a two-year WTG warranty agreement with its existing manufacturer and approached Romax to provide a full WTG inspection service. The initial pilot project will cover eight wind turbines, before then running end of warranty inspections across the remaining 24 turbines.

In addition to end of warranty inspection services, Romax will also provide Mytrah Energy with training and support, equipping its engineers with the necessary skills needed to ensure WTG performance and efficiency improvements across its turbine fleet.



**Romax**  
TECHNOLOGY

“The Indian wind market is growing at an exceptional rate and as a result we are continually looking for new opportunities to improve the performances of our wind turbine fleets,” said Vikram Kailas, managing director of Mytrah Energy. “With a longstanding reputation for wind turbine maintenance expertise, Romax has the potential to help us predict reliability problems and intervene before they happen. We are very happy with the professional attitude of the Romax team and look forward to the results of this trial.”

## C&U Americas

RECEIVES 2014 VALUE IMPROVEMENT AWARD

The North American subsidiary of The C&U Group recently received the 2014 Value Improvement Award from Hitachi Automotive Systems Americas, LLC. The award was presented in recognition of outstanding value improvement and performance achievement. Roy Isaacs, C&U Americas’ se-



nior account manager accepted the award during the fourth Annual Hitachi Automotive Systems Supplier Conference.

“The Value Improvement Award is a particular honor to receive because it recognizes and reinforces C&U’s position in the market,” said Tom Rouse, president of C&U Americas. “We offer our customers ‘World Class Quality, and World Class Value’ by being globally competitive in terms of quality, cost, delivery, service and technology. This important award from Hitachi is a testament to our ability to accomplish these goals.”

**BEYTA GEAR SERVICE**

# PUTTING A LIFETIME OF GEAR DESIGN EXPERIENCE TO WORK FOR YOU

- Reverse engineering
- Gearbox upgrades
- Custom gearbox design
- Specification development
- Project management
- Vendor qualification

- Design reviews
- Bid evaluations
- Tooling design
- Customized gear training
- Equipment evaluation
- Custom machine design

**Charles D. Schultz**  
**chuck@beytagear.com**  
**[630] 209-1652**

**www.beytagear.com**

**Power Transmission Engineering**

## COMPLETELY REDESIGNED!

**Large Editors**

**Following Editor You Can Depend On**

**THE DRIVE TECHNOLOGY SHOW**  
 October 2014 • Denver • Colorado

## Power Transmission Engineering

- Technical content free for everyone
- Comprehensive Buyers Guide
- The latest news

www.**powertransmission.com**

## Applied Mechatronics

TO SERVICE BROTHER GEARMOTORS'S CALIFORNIA CUSTOMERS

Brother Gearmotors recently entered into an agreement with Applied Mechatronics. Applied Mechatronics will commence servicing much of Brother Gearmotors's customer base in California.

As part of the agreement, Applied Mechatronics will serve as a liaison between Brother Gearmotors and many of its California-based customers while sharing its expertise in motion control automation. In addition to servicing existing Brother Gearmotors' customers in California, Applied Mechatronics will work closely with Brother Gearmotors' Business Development Manager, Rob Kaminski, to develop additional customers in the state.



"Applied Mechatronics has a solid reputation as a manufacturers' representative, not only due to its exemplary customer service but its engineers' ability to quickly gain expert knowledge of a company's products, service protocols and other applications," said Matthew Roberson, senior director of Brother Gearmotors. "We look forward to a successful relationship that utilizes our companies' combined strengths, to the benefit of our customers in California."

## Bill Hewitson

NAMED PRESIDENT OF RULAND MANUFACTURING

**Bill Hewitson** was recently promoted to president of Ruland Manufacturing after serving as vice president of operations for the previous eight years. He is the third president in the company's history and succeeds Bob Ruland who will continue to oversee the company as Chairman.

"Bill has been instrumental to the success and growth of Ruland Manufacturing. His deep knowledge of the industry, our products, and our customers as well as his leadership skills make him well qualified to assume the role of President," says Bob Ruland.



Hewitson began his career with Ruland in 1995 as a mechanical engineer. He was responsible for developing most of Ruland's motion control coupling line and has been a key contributor behind the growth of the shaft collar and rigid coupling product lines. He has also contributed to Ruland's international expansion into the Asian and European markets. He is a graduate of Worcester Polytechnic Institute and holds a BS in Mechanical Engineering and a MBA.

## MicroE and Applimotion

MERGE TO BECOME CELERA MOTION

MicroE and Applimotion recently merged to become Celera Motion. The existing MicroE and Applimotion product brand names and positioning will remain unchanged.

The MicroE brand of miniature precision optical encoders is available in several form factors and mounting options with incremental and absolute interfaces and resolutions up to 1.2 nm. A selection of rotary and linear scales delivering accuracy up to 1  $\mu$ m is available.

Applimotion provides optimized solutions ranging from direct drive motor components to fully engineered, validated and tested products and value-add assemblies.

The use of the Celera Motion name is effective immediately, and will be implemented over the remainder of 2015.



## ABB

TO BECOME FIRST GLOBAL INDUSTRIAL ROBOTICS COMPANY TO MANUFACTURE ROBOTS IN THE UNITED STATES

ABB recently announced that it is to start producing robots in the United States, making it the first global industrial robotics company to fully commit and invest in a North American robotics manufacturing footprint. The company made the announcement at the opening of a new robotics plant at its facility in Auburn Hills, MI. Production is to commence immediately.



The new plant is ABB's third robotics production facility, alongside Shanghai, China, and Västerås, Sweden, and will manufacture ABB robots and related equipment for the North American market.

The United States is ABB's largest market with \$7.5 billion in sales. The company has invested more than \$10 billion in local R&D, capital expenditure and acquisitions since 2010, taking local employment from 11,500 to 26,300. Continued investment in the North American value chain and manufacturing constitutes a significant part of ABB's global growth plans reflecting the company's Next Level strategy.

"Today, we are marking and celebrating the next stage of our commitment and growth in North America with the start of local robot manufacturing in Auburn Hills, US," said ABB CEO Ulrich Spiesshofer. "ABB is the first global automation company to open a robot manufacturing facility in the United States. Robotics is a fundamental enabler of the next level of North American industrial growth in an increasingly competitive world. With our continued commitment and investment, our local team is well positioned to support our customers with robotics solutions made in the United States. Our leading technology of web-enabled, collaborative and safe robots will contribute to job security and quality of work."

The portfolio of products manufactured at the new facility will expand in phases, with the goal that most ABB robots and robot controllers delivered in the United States, Canada and Mexico will be manufactured in Auburn Hills. Localized

manufacturing streamlines the delivery process and results in significantly reduced robot lead times for customers.

## Ken Clune

NAMED LAFERT NORTH  
AMERICA NATIONAL DIRECTOR  
OF SALES



Lafert North America (Mississauga, Ontario) recently announced the appointment of **Ken Clune** in the as national director of sales.

Clune brings over 19 years of experience in the electrical industries. Clune has a diverse background and knowledge in the area of sales and marketing for products, services and solutions, through a variety of sales channels. He is passionate about leadership, team work and delivering a positive customer experience.

## GET THE BIG PICTURE

Subscribe today!

## GLOBAL INDUSTRIAL OUTLOOK

Concise, visual, information rich analysis of global manufacturing demand and trends organized by geographic regions and key industry verticals. Built on proprietary, granular collection and organization of core growth trends in orders and sales from 55 key global companies.

Published Quarterly: February, May, August, November

Regular price: \$400 (only \$350 for PTE subscribers)

*Money back guarantee*

Langenberg &  
Company

Subscription requests to:

Ewa@Langenberg-llc.com

www.Langenberg-LLC.com

### USA

#### RESOURCES

Oil & Gas →  
Mining →

#### POWER & ENERGY

Generation →  
Transmission ↑  
Distribution ↑

#### TRANSPORTATION

Road →  
Rail →  
Marine →

#### MACHINERY

Construction ↑  
Mining →  
Truck →  
Agriculture →

#### AUTOMATION

Process ↑  
Industrial ↑

#### FLOW CONTROL

↑

#### IND. MACHINERY, GEN IND.

#### CONSTRUCTION

HVAC →  
C&I →  
Residential ↑

#### CONSUMER

Automotive ↑  
Appliances ↑  
Electronics ↑

#### AVIATION

Commercial ↓  
Military ↓

**September 13-15 – TECHINDIA**

**2015** Bombay Exhibition Centre, Mumbai, India. TECHINDIA will be the ultimate facilitator for b2b cooperation between manufacturers and consumers of all hues connected to the engineering, machinery and manufacturing industry. This leading business event is co-located with five other industry events to make it an extended platform for metal, engineering, manufacturing and machine tools industry: World of Metal – International Exhibition on Metal Producing, Metal Processing and Metal Working Industry; CWE – International Exhibition on Cutting and Welding Equipment; IMEX – International Exhibition on Machine Tools and Engineering Products; UMEX – International Exhibition on Used Machineries; Hand Tools and Fasteners Expo – International Exhibition on Hand Tools and Fasteners. The co-location of industry events will maximize business opportunities for industry professionals. For more information, visit [techindiaexpo.com](http://techindiaexpo.com).

**September 21-23 – Gear Failure Analysis**

Big Sky Resort, Big Sky, MT. Explore gear failure analysis in this hands-on seminar where students not only see slides of failed gears but can hold and examine those same field samples close up. Experience the use of microscope and take your own contact pattern from field samples. Cost is \$1,600 for members and \$2,100 for non-members. For more information, visit [www.agma.org](http://www.agma.org).

**September 29-October 1 – 2015 Gear Manufacturing**

Hyatt Regency, Rochester, NY. This seminar provides the gear design engineer with a broad understanding of the methods used to manufacture and inspect gears and how the resultant information can be applied and interpreted in the design process. Following this seminar, participants will be able to identify methods of manufacturing external and internal spur, single and double helical, and bevel and worm gears, describe the methodology and underlying theory for basic manufacture and inspection of each, and much more. Cost is \$1,430 for member and \$1,930 for non-members. For more information, visit [www.agma.org](http://www.agma.org).

**October 4-7 – Euro PM2015 Congress & Exhibition**

Reims Congress Centre, Reims, France. Europe's annual powder metallurgy congress and exhibition, organized and sponsored by the European Powder Metallurgy Association, will return to France in 2015. The combination of a world class technical program and state-of-the art exhibition will provide the ideal networking opportunity for suppliers, producers and end-users. The program of plenary and keynote addresses, oral and poster presentations and special interest seminars will focus on: additive Manufacturing; hard materials and diamond tools; hot isostatic pressing; new materials and applications; and more. Alongside the technical sessions the Euro PM2015 Exhibition will be an excellent opportunity for international suppliers to the PM industry to network with new and existing customers from the powder metallurgy and associated sectors. For more information, visit [www.europm2015.com](http://www.europm2015.com).

**October 20-22 – Gear Expo 2015**

Cobo Center, Detroit, MI. For more than two decades, power transmission professionals—including CEOs, owners, presidents, engineers, marketing and sales managers, consultants and other executives have come to Gear Expo to learn the latest industry information and see firsthand technology, products, and services that help them expand

and streamline their business. Attendees represent a variety of industries including off-highway, industrial applications, automotive, and oil and gas as well as aerospace, agriculture and construction. They come from around the United States, international manufacturing hubs, and emerging markets to conduct profitable business transactions and collaborate on the innovations that make their operations more streamlined. Exhibitors have the opportunity to meet face-to-face with attendees and other exhibitors and will display more than 750,000 pounds of machinery on the show floor. For more information, visit [www.gearexpo.com](http://www.gearexpo.com).

**October 27 – Modern Furnace Brazing School**

Brazing Engineering Center, Wall Colmonoy Aerobraz Division, Cincinnati, OH. The late Robert Peaslee's tradition continues with the return of the brazing school. The Brazing Engineering Center provides engineering services and training, as well as offering new practical experience on the shop floor. For over 60 years, Wall Colmonoy engineers have gained practical experience on actual problems in brazing plants around the world. Knowledge and practical application will be taught by industry-leading brazing experts. In 1950, Peaslee developed the first nickel-based brazing filler metal, Nicrobraz. Modern Furnace Brazing School will allow you to apply workable solutions to your brazing needs. For more information or to register, contact [brazingschool@wallcolmonoy.com](mailto:brazingschool@wallcolmonoy.com).

**October 27-29 – Discover 2015**

Florence, KY. Mazak Corporation encourages those involved in the metalworking industry to attend its Discover 2015 technology and education event. Here, the machine tool builder plans to spotlight new technologies and trends that will change how part manufacturers operate, including unconventional ways to drive operational efficiency via additive manufacturing, CNC technology and the Industrial Internet of Things (IIoT) concept. Additive manufacturing is creating a shift in the way engineers and designers think about product development, and Mazak is leading the way with its additive-capable INTEGREGX i-400AM. The HYBRID Multi-Tasking machine will make its North American debut at Discover 2015, and attendees will experience how it integrates laser cladding with advanced full 5-axis milling and turning capabilities. Overall, more than 30 of the latest Mazak machine tools will perform real-world cutting demonstrations throughout the event. Applications experts will be on standby during the demonstrations to discuss total manufacturing solutions as well as part-processing improvements with attendees. The company will also offer a series of seminars that will teach attendees the latest metalworking tools, trends and techniques for improved productivity and profitability. For more information, visit [www.MazakUSA.com/DISCOVER2015](http://www.MazakUSA.com/DISCOVER2015).

**November 3-5 – 2015 Detailed Gear Design Beyond Simple Service Factors**

Hyatt Place Las Vegas, Las Vegas, NV. This course explores all factors going into good gear design from life cycle, load, torque, tooth optimization, and evaluating consequences. Students should have a good understanding of basic gear theory and nomenclature. For more information, visit [www.agma.org](http://www.agma.org).

From the Organizer of the World's Most Outstanding Automotive Transmission Meeting Place

4th International

Plus: Transmission Expo



# CTI Symposium

Automotive Transmissions, HEV and EV Drives



16 - 18 September 2015, Marriott Hotel Parkview, Shanghai, China

## Keynote Speakers



**Prof. Ye Shengji** (Senior Engineer),  
Vice General Secretary, China Association of  
Automobile Manufactures (CAAM), China



上海新能源科技成果转化与产业促进中心  
Shanghai New Energy Center for Technology Transfer  
and Industry Promotion

**Liu Wenbo**,  
Director, Shanghai New Energy Center for Technology Transfer and  
Industry Promotion, China



**Zhibin Yang**,  
Director, Chongqing Changan Automobile  
Stock Co. Ltd., China



**Michael Schöffmann**,  
Head of Transmission Development,  
AUDI AG, Germany



**Dr Stefan Heller**, Head of Development Hybrid  
Transmission Inline, BMW Group, Germany



**Dr Rolf Gall**, Head of R&D, Asia Pacific; Head of Engineering  
Center, ZF (China) Investment Co., Ltd, China

## Welcome Address



**Qingwen Li**,  
Chairman of China Energy &  
AutoMobile Media Group Ltd.



**Shengqi Li**,  
Secretary General of China Gear  
Manufacturing Association

## Chairman



**Prof. Dr-Ing. Ferit Küçükay**, Managing Director, Institute of Automotive  
Engineering, Technical University of Braunschweig, Germany

Expert presentations e.g. by:

**GEELY**

**Porsche Engineering**  
driving technologies



**TOYOTA**

Sponsor:



**GETRAG**



Simultaneous Translation English ↔ Chinese  
Conference documentations in English & Chinese

CTI Symposium World Series  
2,200+ in China, USA & Europe in 2014!  
Representatives from over 20 countries!

Programme in English and Chinese available at:  
[www.transmission-symposium.com/china](http://www.transmission-symposium.com/china)

**CINCINNATI GEARING SYSTEMS INC.**

**WE DON'T JUST MAKE GEARS, WE SUPPORT THEM TOO.**

• Engineering Support  
• Field Service  
• Vibration Analysis  
• Overhaul  
• Troubleshooting  
• Failure Analysis  
• Design Audits  
• Inspection & Testing  
Per API 613/677/617/672

Full Service Gear Manufacturing & Heat Treating  
Gearbox Designs to AGMA 6011, API 613/677/617/672

www.cincinnati gearing systems.com | 513-527-8600 | gearsales@cat-c.com

Manufactured Domestically. Trusted Internationally.™

## CALL FOR PAPERS!

Are you sitting on an idea for a technical paper but wondering where to present it? Do you have one already written, sitting on your desk, gathering machine dust?

How about *Power Transmission Engineering*? We are always looking for gearing- and power transmission component-relevant technical papers for publication in the magazine and in its digital version. Having your work appear in *Power Transmission Engineering* guarantees you an audience of the most experienced and discriminating industry players. You say your work has not been peer-reviewed? Not a problem, as we are lucky—and thankful—to have on-hand some of the most experienced and brilliant minds in the industry—our technical editors. So if your work “passes muster” and is published, you’ll know you were reviewed by the best—and most demanding.

Chances are you’ll be creating the paper under the auspices of the company for whom you work or own, or for one of the various industry-relevant associations. That means they as well will bask in the reflected glory that accrues with publication in *Power Transmission Engineering*.

For publication guidelines and more information, please contact Jack McGuinn at [jmcguinn@powertransmission.com](mailto:jmcguinn@powertransmission.com).

### Affiliated Distributors

Page 13  
<http://adhq.com/win>

### AGMA (Gear Expo)

Page 19  
[www.gearexpo.com](http://www.gearexpo.com)

### Automation Direct

Inside Front Cover  
[www.automationdirect.com](http://www.automationdirect.com)

### B&R Machine and Gear

Page 9  
[www.brgear.com](http://www.brgear.com)

### Beyta Gear Service

Page 57  
[www.beytagear.com](http://www.beytagear.com)

### Brevini Gear

Page 16  
[brevinigeart.com](http://brevinigeart.com)

### Cincinnati Gearing Systems

Page 62  
[www.cincinnati gearing systems.com](http://www.cincinnati gearing systems.com)

### Circle Gear

Page 12  
[www.circlegear.com](http://www.circlegear.com)

### CTI—Car Training Institute

Page 61  
[www.transmission-symposium.com/china](http://www.transmission-symposium.com/china)

### Diequa Corp.

Page 14  
[www.diequa.com](http://www.diequa.com)

### Erasteel

Page 31  
[www.erasteel.com](http://www.erasteel.com)

### Framo Morat

Page 29  
[www.framo-morat.com](http://www.framo-morat.com)

### Gear Expo

Page 19  
[www.gearexpo.com](http://www.gearexpo.com)

### IDC USA

Page 21  
[www.idcselect.com](http://www.idcselect.com)

### J.W. Winco Inc.

Page 2  
[www.jwwinco.com](http://www.jwwinco.com)

### Lafert North America

Page 17  
[www.lafertna.com](http://www.lafertna.com)

### Langenberg & Co.

Page 59  
[www.langenberg-llc.com](http://www.langenberg-llc.com)

### Mach III Clutch

Page 25  
[www.machiii.com](http://www.machiii.com)

### McInnes Rolled Rings

Page 23  
[www.mcinnesrolledrings.com](http://www.mcinnesrolledrings.com)

### Motion Industries

Page 5  
[www.motionindustries.com](http://www.motionindustries.com)

### Nachi America

Page 35  
[www.nachiamerica.com](http://www.nachiamerica.com)

### Ningbo Zhongyi Hydraulic Motor Co.

Page 11  
[www.zihyd.com](http://www.zihyd.com)

### Nordex Inc.

Page 10  
[www.nordex.com](http://www.nordex.com)

### QA1 Precision Products, inc.

Page 55  
[www.salesqa1.net](http://www.salesqa1.net)

### R+W America

Page 22  
[www.rw-america.com](http://www.rw-america.com)

### Rave Gears and Machining LLC

Page 15  
[www.ravegears.com](http://www.ravegears.com)

### Schaeffler Group

Back Outside Cover  
[www.schaeffler.us](http://www.schaeffler.us)

### Sesame Motor

Page 2  
[www.sesamemotor.com](http://www.sesamemotor.com)

### SEW-Eurodrive

Inside Back Cover  
[www.seweurodrive.com](http://www.seweurodrive.com)

### SKF

Page 3  
[www.skf.com](http://www.skf.com)

### Smalley Steel Ring Co.

Page 18  
[www.smalley.com](http://www.smalley.com)

### SMT—Smart Manufacturing Technology

Page 7  
<http://masta.smartmt.com>

### Suhner Manufacturing

Page 55  
[www.suhner.com](http://www.suhner.com)

### Techtop Industries

Page 27  
[www.techttopind.com](http://www.techttopind.com)



# Power Transmission Engineering



**Power Transmission Engineering** is Your KEY to understanding Gears, Gear Drives, Bearings, Motors, Clutches, Couplings, Brakes, and other Power Transmission Components.

Unlock your FREE subscription by filling out this form.

## FREE SUBSCRIPTION

**1**  **YES** I want to receive/continue to receive **Power Transmission Engineering** FREE!  
 No thank you.

Name: \_\_\_\_\_ JobTitle/Position: \_\_\_\_\_  
(print)

Signature \_\_\_\_\_ Date: \_\_\_\_\_  
(required)

**2** → E-mail \_\_\_\_\_  
(So we can notify you when the online edition is available)

 **SAVE a TREE!**  
 I ONLY want the digital edition (e-mail required)

**3** → Please update your contact information or attach you business card here. (No Staples)

Company Name: \_\_\_\_\_  
 Address: \_\_\_\_\_  
 \_\_\_\_\_  
 \_\_\_\_\_  
 City: \_\_\_\_\_  
 State/Province: \_\_\_\_\_ ZIP+4/Postal Code: \_\_\_\_\_  
 Country: \_\_\_\_\_  
 Telephone: \_\_\_\_\_ Fax: \_\_\_\_\_  
 E-mail: \_\_\_\_\_  
 Website: \_\_\_\_\_

**5** → My company's principal product or service is: \_\_\_\_\_

**6** → What is your primary job function responsibility? (Check one)

<input type="checkbox"/> Corporate Management (1)	<input type="checkbox"/> Quality Control (7)
<input type="checkbox"/> Plant Engineering (2)	<input type="checkbox"/> Factory Automation (8)
<input type="checkbox"/> Design Engineering (3)	<input type="checkbox"/> Maintenance (9)
<input type="checkbox"/> Marketing & Sales (4)	<input type="checkbox"/> Other (10)
<input type="checkbox"/> Manufacturing Engineering (5)	
<input type="checkbox"/> Purchasing (6)	

Is there a colleague within your company that might benefit from having their own copy of **Power Transmission Engineering** magazine?

Name: \_\_\_\_\_  
 Title: \_\_\_\_\_

**4** → How is THIS LOCATION involved with power transmission products? (Check all that apply)

WE MAKE power transmission products (10)  
 WE BUY power transmission products (12)  
 WE SELL power transmission products (Distributors, sales reps. etc.) (14)  
 WE DESIGN products with power transmission components in them. (16)  
 Other (please describe) (15) \_\_\_\_\_

**DIGITAL SUBSCRIPTIONS**

**YES, I want to be notified each issue when *Power Transmission Engineering* is available online**

**YES, I would like to receive *Power Transmission Engineering's* monthly e-mail newsletter**

**YES, I would like to receive *Power Transmission Engineering's* twice monthly e-mail Product Alerts**

**YES, I would like to receive 3rd-party e-mails from *Power Transmission Engineering's* advertisers and partners**

**YES, I would like to receive subscription renewal notices by e-mail**

**No, I do not wish to be contacted by e-mail.**

**FAX TO 1-847-437-6618** or  
 VISIT US ONLINE AT  
[www.powertransmission.com/subscribe.htm](http://www.powertransmission.com/subscribe.htm)

# This Tattoo Machine is Off the Chain

## (Full disclosure: Apologies to my roommate ahead of time)

Erik Schmidt, Assistant Editor

People covered gauge to tibia in tattoos are — **WARNING:** terrible pun forthcoming — *colorful* individuals.

Groan inducing, yes — but truer than the blue-soaked dermis layer of infamous ink fiend The Enigma (if you're not familiar with the tattoo/sideshow icon, he's basically an R-rated version of Papa Smurf who eats fire and twirls chainsaws). Though other altered individuals obviously operate on a much less extreme plane of body modification, there seems to be a definite link between the ink and the irregular.

It's like some sort of artsy-fartsy sacrificial pact.

I should know. My roommate is a tattoo artist. He has a narwhal tattooed on his right calf and a black ring hooked in his nostril.

Don't get it twisted, though. As much as some "normal" folk will sneer or clutch their purses tight as tatted heathens stroll by, tattooers and tattooees are by no means *bad* people (full dis-

closure: My roommate is far more likely to spend his weekends playing Nintendo than causing any sort of ruckus). But they are, more often than not, *different* ones (more full disclosure: My roommate, for whatever reason, has a black and grey portrait of his former boss's ex-wife tattooed on his right thigh).

So...yeah.

These are without question unique human beings we're talking about here, ones who have had — for lack of a better term — a slight chemical imbalance since birth (even more full disclosure: My roommate spends more money on Amiibo figurines and movie posters than he does on rent).

Clearly, these are not people tethered to the ropes of reality.

This is why it's all the more surprising that they've gone so long operating machines with cords attached to them.

Well, leave it to the people who helped put a manmade vessel on a comet tearing through space to finally give tattoo artists total uninhibited freedom: Introducing the "Unchained" cordless tattoo machine from Swisstattoomachine, powered by Maxon Motors.

Unchained? Yup — this machine is literally off the hook.

Released in the summer of 2014, the Unchained took Swisstattoomachine CEO Enrico Friedli three and half years to develop. It uses Maxon's RE 13 DC motor with 2.5 W. The motor has an ironless rotor and high-power, rare-earth permanent magnets.

OK, so that's pretty cool. And there's a weird little place in my heart that sings for all the tattooed oddballs out there clamoring for a beautifully twisted world without wires. But the real question is: Is there any substance to all this style?

"It's quiet and it's long life," said In-cremotion Inc. President Dan Jones on the benefits of this type of motor for a cordless tattoo machine. "And, most importantly, it's extremely accurate."

In a business that centers on inserting indelible ink into skin, that last part seems particularly valuable. Getting a medium-sized toothed whale etched into your body is a sketchy enough proposition without having to worry about blown out lines on its jagged little horn.

According to Maxon, the Unchained hardly makes any noise and has very low vibrations. It's also lightweight, something that is important for artists that need to hold the tattoo machine in their hands for hours on end. At 140 gram, the Unchained is only 20 gram heavier than its predecessor model, which has a power cord. The number of strokes per minute can be adjusted at the device, ranging from 3,000 to 6,000. Hygiene is another added benefit, as typically the cord of a tattoo machine must be wrapped in a plastic hose to prevent any sort of contamination.

"I have a lot more freedom of movement and don't have to be careful about the power cord," Swiss tattoo artist Alena Lizier told Maxon Motor's magazine *Driven* last year.

In the same article, Friedli added:

"By their nature, rotary machines are much less noisy and produce less vibration than coil machines. This makes them an ideal choice for liners, machines used for outlines and black ink drawings. They are also reliable, durable and low maintenance. However, I think that coil machines will always find buyers, if only out of pure nostalgia, similar to vinyl records."

(Which brings me to one last bit of full disclosure: My roommate once dated a pink-haired girl who claimed that Jack White — yeah, *that* Jack White — had the best-selling vinyl record of all-time).

Turns out she was only off by about 40 million.

Luckily for my roommate, the Unchained has proven to be much more accurate. **PTE**





## The only tool you'll ever need.

Stop wasting your valuable time fumbling through catalogs, price books and emails to specify a gear unit or gearmotor. Just go straight to the PT Pilot® selection tool from SEW-EURODRIVE!

PT Pilot® quickly provides quotes, parts lists, 3D CAD drawings, motor options, gear options and variable frequency drives with just a few keystrokes.

It is also compatible with smartphones and tablets. Now, you can literally obtain a quote at your fingertips anytime, anywhere!

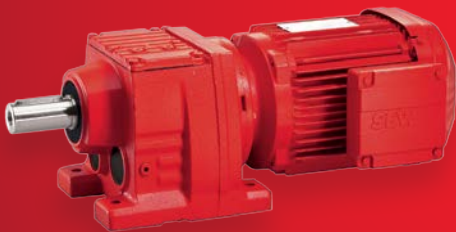
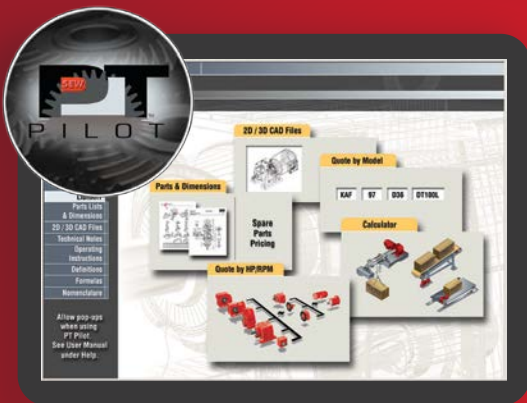

**SCHAEFFLER**



### Uncork Some Schaeffler Reliability with KUBE

Schaeffler's innovative 4-row linear recirculating ball bearing and guideway system, KUBE is designed to keep your packaging machines moving by effectively vanquishing those dreaded causes of downtime: inadequate lubrication and contamination. Featuring our exclusive X-life™ technology, KUBE is synonymous with extra-long maintenance intervals and maximum productivity.

#### SUPERIOR LUBRICATION • OPTIMUM SEALING

With an integrated, patented lubrication channel in the carriage's load zone that stores grease where it's needed and an innovative one-way lubrication valve that ensures consistent grease flow, **KUBE delivers longer lubrication intervals than any competitor's bearings on the market.** Meanwhile, advanced, low-friction seals offer optimum protection against contamination with minimal displacement resistance.

Choose KUBE and bottle up downtime, not your profits!

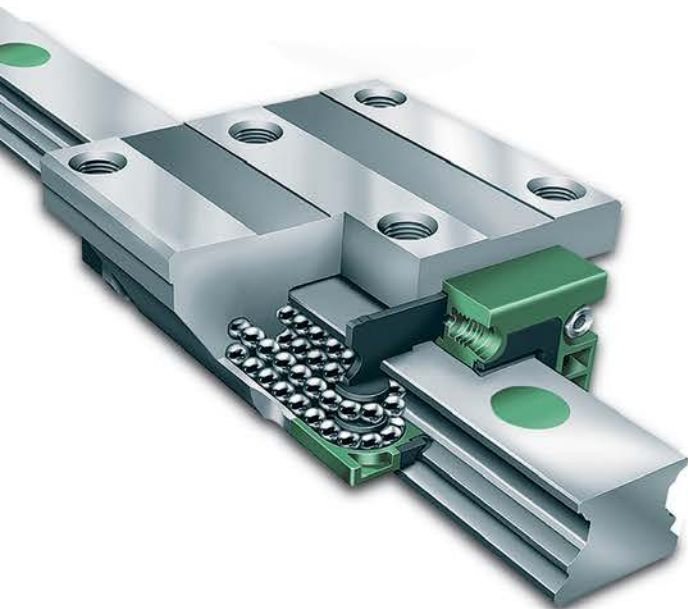

Need more details?  
Please contact us at [info.us@schaeffler.com](mailto:info.us@schaeffler.com)  
[www.schaeffler.us](http://www.schaeffler.us)

©2015

Superior-quality products.  
Comprehensive reliable solutions.

