

# Power Transmission Engineering

FEBRUARY 2016

## MECHATRONICS MATTER

### PLUS

Helical-Bevel Gear Drives  
Washdown-Duty Motors  
Bearing Briefs  
Best Practices Motor  
Management, Part III



ARROW  
GEAR  
COMPANY

ARROW  
VISION

SEE IT IN YOUR RESULTS

## THE ARROW GEAR STOCK PROGRAM

NOT YOUR AVERAGE  
STOCK GEARS

What makes Arrow's stock gear product line so unique? It's the level of precision. All Arrow stock spiral bevel gears are produced the same way we manufacture gears to meet the demands of the aerospace industry – with precision machining, precise inspection and high quality assurance.



What's not unusual is the many ways our customers use them. Whether they need to speed prototyping, improve lead time or find a cost-effective alternative for low production volumes, our stock gear program gets them there faster – at a lower cost.

See it in your results.  
Download our Stock Gear Catalog at  
[arrowgear.com/catalog](http://arrowgear.com/catalog)

# Power Transmission Engineering®

FEBRUARY 2016



## FEATURE ARTICLES

- [18] **Mix and Match Mechatronics**  
Smart technology thrives in heavy-industrial market.
- [24] **Two-stage Helical Bevel Gearing**  
Option for 3-stage helical bevel gearbox and worm gearing.
- [28] **Reducing Food Processing Plants' Energy Costs**  
Highly efficient washdown motors make dramatic impact.
- [31] **Engineering sMart**  
Our new special section brings you bright ideas.

## TECHNICAL ARTICLES

- [36] **Homogeneous Geometry Calculation of Arbitrary Tooth Shapes**  
Mathematical approach and practical applications.
- [46] **Motor Management Best Practices, Part III**  
Repair specifications and preventive/predictive maintenance.

Vol. 10, No. 1. POWER TRANSMISSION ENGINEERING (ISSN 2331-2483) is published monthly except in January, May, July and November by Randall Publications LLC, 1840 Jarvis Ave., Elk Grove Village, IL 60007, (847) 437-6604. Cover price \$7.00. U.S. Periodicals Postage Paid at Elk Grove Village IL and at additional mailing offices. Send address changes to POWER TRANSMISSION ENGINEERING, 1840 Jarvis Ave., Elk Grove Village, IL 60007.

Randall Publications LLC makes every effort to ensure that the processes described in POWER TRANSMISSION ENGINEERING conform to sound engineering practice. Neither the authors nor the publisher can be held responsible for injuries sustained while following the procedures described. Postmaster: Send address changes to POWER TRANSMISSION ENGINEERING, 1840 Jarvis Avenue, Elk Grove Village, IL, 60007. ©2016 Contents copyrighted by RANDALL PUBLICATIONS, LLC. No part of this publication may be reproduced or transmitted in any form or by any means, electronic or mechanical, including photocopying, recording, or by any information storage and retrieval system, without permission in writing from the publisher. Contents of ads are subject to Publisher's approval.

# Power Transmission Engineering

VOL. 10, NO. 1

## MISSING A PIECE?

We've got you covered! Go to [powertransmission.com](http://powertransmission.com) to see what you missed in last month's issue, plus another eight years of back issues, industry and product news, and more!

In last month's issue:

- Our annual Buyers Guide
- Choosing chain or belt drives
- The industrial Internet is changing everything
- Preventing Roller Bearing Failure

...and more!

## Power Transmission Engineering

- [04] **PTEExtras**  
Our online Tipsheet for what's not to be missed
- [06] **Publisher's Page**  
Engineering Smart
- [08] **Product News**  
The newest hardware and software.
- [32] **BSA Bearing Briefs**  
Bearing Specialists Association makes PTE debut.
- [34] **BSA Field Notes**  
Identifying cause of bearing failure in a lime quarry operation.
- [54] **Global Industrial Outlook**  
Oil Slick Cascading Through Sector.
- [56] **Industry News**  
News worth knowing about.
- [60] **Calendar of Events**  
**March 15–17:** Fundamentals of Gear Design University of Wisconsin-Milwaukee, School of Continuing Education.  
**March 16–18:** Introduction to Electric Machines and Drives Madison, Wisconsin  
**March 22–23:** AWEA Wind Project Siting and Environmental Compliance Conference 2016 Charleston, South Carolina.
- [62] **Advertiser Index**  
How and where to reach every supplier in this issue.
- [63] **Subscriptions**  
Free subscriptions, anywhere in the world.
- [64] **Power Play**  
Gyroscopes in Spaaaaace!



Cover photo courtesy of Bosch Rexroth

# Gearing your past to power your future.



## Quality precision with every process.



### Breakdown Services

We understand the urgency of meeting critical deadlines. We offer our customers expedited services without sacrificing quality.

### Heat Treatment

Our in-house heat treat facility performs a full range of services that include annealing, carburizing, and thru hardening.



B&R Machine and Gear Corporation is a full service gear manufacturing facility driven to power your equipment with reliable and durable gears that are built to perform and last. Find the perfect mesh. No matter the gear, we've got you covered.

VISIT OUR WEBSITE [BRGEAR.COM](http://BRGEAR.COM) FOR MORE INFORMATION

## Back to Basics

Our continuous push to get you the technical information you need regarding PT components just got easier at [www.powertransmission.com](http://www.powertransmission.com). Our Back to Basics section delivers quick access to topics such as application guides, product selection and sizing, gear design and more. This section is perfect for anyone new to the power transmission industry or for those looking to refresh their skills.



## PTE Featured Topics



The PTE homepage ([www.powertransmission.com](http://www.powertransmission.com)) features an in-depth collection of mechanical component and motion control content. Articles are indexed by subject, so all you have to do is type what you're looking for in the search bar.

This Month's Highlighted Topics:

**Bearings**  
**Gear Drives**

## Social Media

Have you browsed our Twitter page recently? We've added the latest PT news and product information from companies like ABB, Icus, MCMA and Santasalo. Check out these and other PT manufacturing topics here: <https://twitter.com/PowerTransMag>

Facebook is another resource that features updates on the Bearing Blog, additional Ask the Expert resources and a quick and convenient way to renew your PTE magazine subscriptions: [www.facebook.com/Power-Transmission-Engineering-524202381060172](http://www.facebook.com/Power-Transmission-Engineering-524202381060172)



## Event Spotlight

### Reliable Plant 2016

Kentucky International Convention Center, Louisville, KY. Reliable Plant is the industry's premier global event focused on lubrication, oil analysis and reliability. Manufacturing professionals from around the globe attend Reliable Plant to benchmark best practices, see and learn the latest technologies, and make new contacts. Reliable Plant features three days of comprehensive presentations and workshops covering today's trends and hot-topic issues. For more information, visit [www.powertransmission.com/news/6756/Reliable\\_Plant\\_2016/](http://www.powertransmission.com/news/6756/Reliable_Plant_2016/).

## Stay Connected



Follow us on Twitter  
[twitter.com/PowerTransMag](https://twitter.com/PowerTransMag)



Connect with us on LinkedIn  
[www.linkedin.com/groups/Power-Transmission-Engineering-PTE-2950055](http://www.linkedin.com/groups/Power-Transmission-Engineering-PTE-2950055)



Subscribe Online  
[www.powertransmission.com/subscribe.htm](http://www.powertransmission.com/subscribe.htm)

# Power Transmission Engineering

## Randall Publications LLC

1840 Jarvis Avenue  
Elk Grove Village, IL 60007  
Phone: (847) 437-6604  
Fax: (847) 437-6618

### EDITORIAL

#### Publisher & Editor-in-Chief

Michael Goldstein  
[publisher@powertransmission.com](mailto:publisher@powertransmission.com)

#### Managing Editor & Associate Publisher

Randy Stott  
[wrs@powertransmission.com](mailto:wrs@powertransmission.com)

#### Senior Editor

Jack McGuinn  
[jmcguinn@powertransmission.com](mailto:jmcguinn@powertransmission.com)

#### Senior Editor

Matthew Jaster  
[mjaster@powertransmission.com](mailto:mjaster@powertransmission.com)

#### News Editor

Alex Cannella  
[alex@geartechnology.com](mailto:alex@geartechnology.com)

#### Editorial Consultant

Paul R. Goldstein

### ART

#### Art Director

David Ropinski  
[dropinski@powertransmission.com](mailto:dropinski@powertransmission.com)

### ADVERTISING

#### Advertising Sales Manager & Associate Publisher

Dave Friedman  
[dave@powertransmission.com](mailto:dave@powertransmission.com)

#### China Sales Agent

Eric Wu  
Eastco Industry Co., Ltd.  
Tel: (86)(21) 52305107  
Fax: (86)(21) 52305106  
Cell: (86) 13817160576  
[eric.wu@eastcotec.com](mailto:eric.wu@eastcotec.com)

#### Materials Coordinator

Dorothy Fiandaca  
[dee@randallpublications.com](mailto:dee@randallpublications.com)

### DIGITAL

#### Content Manager

Kirk Sturgulewski  
[kirk@powertransmission.com](mailto:kirk@powertransmission.com)

### CIRCULATION

#### Circulation Manager

Carol Tratar  
[subscribe@powertransmission.com](mailto:subscribe@powertransmission.com)

#### Circulation Coordinator

Barbara Novak  
[bnovak@powertransmission.com](mailto:bnovak@powertransmission.com)

### RANDALL PUBLICATIONS STAFF

#### President

Michael Goldstein

#### Accounting

Luann Harrold





**PART FAILS. FINGERS POINT.  
PROGRESS HALTS.  
NOT A PRETTY PICTURE.**

**Reliability earned us our reputation. With more products than ever, it will also ensure we keep it.**

At Schafer Industries, our reputation for superior gear solutions has led us into a more diverse product offering. Our capital investments mean tighter tolerances, more efficient automation and expanded capabilities including large-scale gears for construction/mining applications and driveline extensions resulting in reduced gear noise and improved strength.

Here at Schafer, we're continually investing in our future in terms of technology and the caliber of people we hire. Backed by a workforce committed to quality, our engineering teams provide innovative, custom solutions. Our customer service staff understands the value of business relationships and our on-time delivery record is second to none. So whether you're in the automotive, truck, marine, off-road leisure, heavy equipment or aviation industry, Schafer has the capabilities to deliver. For more information visit us online.

**SCHAFER**  
INDUSTRIES

[SchaferIndustries.com](http://SchaferIndustries.com)

# Engineering Smart

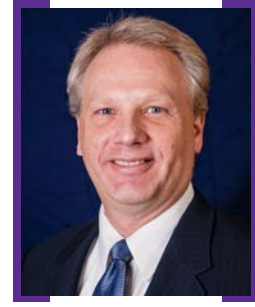

Our theme for 2016 is “Engineering Smart.” Our goal as a publication is to help you engineer better systems, taking advantage of the latest in technology to create mechanical systems that last longer, save energy, cost less and increase performance. The way we do that is by bringing you the best information possible on the design and engineering of gears, gear drives, bearings, motors, couplings and related power transmission components and systems.

In fact, we like the idea so much that we’ve created a new department in the magazine called Engineering sMart (page 31). This is a special advertising section that includes many of the most important new products, technologies and processes in the power transmission world. Engineering sMart is a marketplace as well as a showcase of these important technologies. We hope you’ll check the section often for ideas about new products and services to help you make your own smart engineering choices.

In addition, we’re pleased to announce a collaboration with the Bearing Specialists Association. We’ve partnered with the BSA to help bring you timely, relevant and useful information about the technical aspects of bearings that will help you make smart choices when it comes to designing new equipment or replacing bearings in existing equipment. The first installment of a new column, *Bearing Briefs*, can be found on page 32 of this issue. This issue’s *Bearing Brief* deals with the subject of counterfeit bearings and the potential consequences of using them. We look forward to a long and fruitful partnership with the BSA, and we’re confident that you’ll benefit from the addition of their information to our pages.

We’re also pleased to announce a new column called *Field Notes* (page 34). In this special department, we’ll bring you tales from the field regarding successful implementations of new technology, transitions and upgrades of power transmission equipment and descriptions of other problems solved by experts in our industry. The BSA was kind enough to help out with this column as well, and this issue’s *Field Note* includes a case study on identifying bearing failure from Certified Bearing Specialist Guy Gendron of Timken Canada. If you have a short case study that demonstrates the idea of “engineering smart” and you’d like to contribute a *Field Note* for a future issue, please contact Senior Editor Matt Jaster via e-mail at [mjaster@powertransmission.com](mailto:mjaster@powertransmission.com).

But that’s not all. We have a great lineup of articles covering a wide variety of power transmission topics. This issue’s cover story is on mechatronics, and you can turn to Matt Jaster’s article on page 18 for insights from Bosch Rexroth, Schaeffler Group and SKF on the ways mechatronics is finding practical applications in heavy industrial applications. Plus, we have great pieces on gear drives (page 24), wash-down-duty electrical motors (page 28) and gear design (page 36), along with the third and final installment of our series on motor management best practices (page 46).

We wouldn’t be able to pull off the concept of “engineering smart” without all of our smart contributors, so we’d like to thank everyone who wrote for us this issue, as well as all those who were gracious enough to be interviewed by our editors. We’re always looking for more contributors, so if you have an idea you’d like to share, we’d love to hear from you, too. Send me an e-mail at [wrs@powertransmission.com](mailto:wrs@powertransmission.com) with your ideas.

Thanks for reading.

A handwritten signature in black ink that reads "Randy Stott". The signature is written in a cursive, flowing style.



# Setting Ideas Into Motion

**SDP/SI**  
STOCK DRIVE PRODUCTS  
STERLING INSTRUMENT

REGISTERED  
**ISO 9001**  
**AS 9100**

**From Prototype to Production**  
**In-House Custom Design, Development,**  
**Manufacturing, Assembly and Testing**

Over 55 years experience  
High-quality machined parts  
Molded components  
Precision gears  
Gear assemblies



- Call us about your application
- Request a tour of our facility
- Send drawings & request a quote online

**Phone: (800) 819-8900**

**[www.sdp-si.com](http://www.sdp-si.com)**

# Heavy Duty Welding

ROTARY TABLE IMPLEMENTATION DELIVERS QUALITY AND PRECISION FOR PLUMBING APPLICATION

For over 40 years, LSP Products Group, Inc. has been developing innovative polymer products for the plumbing industry. With a manufacturing plant featuring 11 injection molding machines, LSP molds most of their wholesale plastic plumbing parts in the United States. LSP was looking for solutions to replace their manual assembly line processes and ineffective conveyor options particularly for two new plumbing products to be produced in ultrasonic and spin welding operations.

Since the welders have applied force pressure and small part size, rotary indexing tables present a perfect option for small progressive production. LSP's Marshall Henningsen, director of manufacturing and Jim Ross, manufacturing engineer, soon began to investigate solutions which led them to Weiss North America, Inc.

Originally, LSP was planning on building and implementing their automation internally on their own chassis. However, the Weiss sales and engineering team provided them with a 3D CAD model of a Weiss chassis along with a unique configuration proposal based on their TC (150/220) Series tables. The proposed Weiss chassis allowed LSP to readily implement their own automation for two machine designs.

A key design element that both machines had to address was overcoming the large downward forces (400lbs.) from the servo-driven welders, to melt plastic that was exacted onto the in-

dex table's tool plate in repeated production. To overcome this, an anvil back-up support was designed underneath to absorb the intense loads from the welders—ultimately promoting longer production life for the tables and plates.

The cornerstone to achieving each chassis system's production goal was implementing Weiss' third

generation configuration TC heavy duty rotary indexing tables—TC150 (six station) and TC220 (eight station) Both tables feature a hard coat anodized plating finish on the aluminum jig plate. This coating is essential in providing durability versus the intense downward force pressure subjected on the anvil that supports the plate.

LSP is producing a new, in-line hammer arrester made out of polymers vs. traditional copper. The patented, first of its kind in-line polymer hammer arrester can be integrated into water connectors such as washing machines, ice makers, dishwashers or directly into the plumbing system's piping to smooth out the pressure fluctuations associated with modern appliances.

Utilized for greasing, inserting components and ultrasonic welding operations in six stations, the Weiss chassis system includes the TC150 index table (32" diameter, 3/4" thickness), tool plate, machine frame, and an anvil back-up support for the tool plate.

LSP leveraged the Weiss eight station chassis system for plumbing industry applications such as toilets, faucets, etc. The semi-automated system includes the TC220 index table



LSP was looking for solutions to replace their manual assembly line processes and ineffective conveyor options for two new plumbing products and utilized a rotary table configuration from Weiss N.A.

(42" diameter, 3/4" thickness), tool plate, machine frame and an anvil back-up support for the tool plate.

Production features seven assembly stations and a servo spin welder station that uses radial motion to apply over 300lbs. of force pressure to friction-weld plastic part halves. Weiss designed the anvil support located underneath the center of the tooling head to effectively offset the force applied to the parts and the table during repeated station component spin welding. In addition, the robust rotary table platform provides accurate, level locations for pick and place automated assembly of the polymer quarter turn valve.

Weiss completed and shipped the smaller TC150-6 station unit in April 2015, and the larger TC220-8 station unit in October of 2015. Both units are nearing completion of advanced production of the innovative LSP polymer plumbing parts. Notably, the inclusion of the anvil back-up support will ensure advanced longevity for the system's core index table and tool plate against repeated welding production force pressures.

**For more information:**

LSP Products Group Inc.  
Phone: (800) 854-3215  
[www.lspproducts.com](http://www.lspproducts.com)

Weiss North America, Inc.  
Phone: (440) 269-8031  
[www.weissna.com](http://www.weissna.com)



An anvil back-up support was designed by Weiss underneath the table to absorb the intense loads from the welders—ultimately promoting longer production life for the tables and plates.



## ***PRECISE. ROBUST. AVAILABLE***

These new generation CD® Couplings feature zero backlash precision and high torsional stiffness. They answer today's demanding needs in servo motor applications with high reverse loads and positioning requirements. New clamp style hubs handle increased torque on shafts without using keyways. Manufactured of RoHS compliant materials.

Now size, select and see the right CD® Coupling solution for your coupling application with Zero-Max 3D CAD files.

Check our FAST deliveries.



[www.zero-max.com](http://www.zero-max.com) 800.533.1731

**////// ZERO-MAX®**

## Timken 6000 Ball Bearings

RELEASED IN NORTH AMERICA

Timken recently launched its 6000 series deep groove ball bearing line in North America, which completes the company's global roll-out of the series to its OE customer base and global distributor network. The new line, which is used in a wide variety of applications and conditions, meets ISO standards and dimensionally interchanges easily with competitor products. It reflects another step in the company's ongoing commitment to offer Timken customers and end users an even broader range of bearings and power transmission components. "Timken expanded its ball bearing supply chains to grow its deep groove ball bearing line and deliver product engineered to rigorous Timken quality standards," said Hans Landin, vice president of power transmission products for Timken. "We expect this initiative to improve the com-



petitive position of both the company and our customers."

Landin also indicated that Timken plans to continue expanding its ball bearing offering as part of the company's DeltaX growth strategy. "We want to be the 'one-stop shop' for bearings and power transmission products and services for Timken customers worldwide," he said.

**For more information:**

Timken  
Phone: (234) 262-3000  
[www.timken.com](http://www.timken.com)



### THIN ENOUGH?

**BXR Brakes**

- Up to 480 in-lbs static
- Up to a 1.125" bore
- 19 watts or less
- Produced for over 10 years

Our Innovative design features a very thin profile, reducing weight and saving space.

**For more information:**  
Call: 800.533.1731  
[www.mikipulley-us.com](http://www.mikipulley-us.com)



## Aerotech Gimbals

OFFER HIGH ACCURACY POSITIONING

A series of gear-driven motorized gimbals for high-accuracy elevation-over-azimuth positioning has been introduced by Aerotech. The new AMG-GR two-axis optical mounts are available in numerous standard travel ranges and customized travels are easily accommodated from 90 degrees to continuous rotation. Accuracy of  $\pm 10$  arc sec and a variety of motor types, and cell designs make these gimbal mounts appropriate for applications ranging from sensor calibration to laser beam steering. Standard circular cells range from 100-300 mm diameter. Mounting options include a centered (balanced) cell or a front-surface reflection configuration. The gimbals are available with either brushless servo or stepper motors, with a full range of matching drives and controls. Vacuum-compatible versions



are also available. A direct encoder option allows increased accuracy and repeatability. Special configurations accommodate non-circular optics, cameras, sensors, and round optics larger than 300 mm in diameter. The gimbal's modular-design approach allows each mirror cell to be easily modified or replaced to accommodate sensors or other asymmetrically-shaped payloads.

**For more information:**

Aerotech  
Phone: (412) 963-7470  
[www.aerotech.com](http://www.aerotech.com)

**Extraordinary People Make the Difference**

*Molly Vongphichith  
Setup Technician  
(In Training)*

**We're training her to  
run the company some day**

Molly is just one of the rising young superstars finding challenge and fulfillment at Forest City Gear. While her career in gears is just starting out, she's already received more training than the typical manufacturing worker twice her age – everything from ITAR to ISO 9000, 6S to AS 9001, material handling to quality management, and much more.

Searching for a gear manufacturer with more talent? You've come to the right place.

***Excellence Without Exception***

**FOREST CITY GEAR**



815-623-2168 | [www.forestcitygear.com](http://www.forestcitygear.com)

# AutomationDirect Couplings

ADDED TO SUREMOTION LINE

Rotating shaft-driven mechanical components are commonly used in all forms of machinery that perform the various processes and functions of modern industry. While perfect alignment of shafts and rotating components is desired, shaft ends can often be misaligned. This misalignment places stress on shafts and related parts, which can result in the early failure of both. Drive couplings are often used to compensate for shaft misalignment, whether the misalignment is an intentional or an unintentional part of the design. AutomationDirect's new SureMotion drive couplings are available in four styles: jaw/spider, double loop, Oldham, and beam-style servo; bore reducers are also offered to fit a coupling when the exact bore is not available.

The SureMotion jaw/spider coupling is a clamp-style coupling with 14 to 65mm aluminum hubs and bore diameters ranging from 3/16" to 32mm. Polyurethane center "spiders" are avail-

able in different durometers for different degrees of shock and vibration reduction. Double loop couplings provide high torsional rigidity in a one-piece design. Hubs are made of series 300 stainless steel with corrosion protection against acids, alkalis, solvents, oils, grease and ozone. Available in 10mm to 40mm hub sizes, double loop couplings dampen shock and vibration and operate at speeds of up to 3,000 rpm.

Oldham drive couplings feature aluminum hubs in 19mm to 57mm sizes and have a large radial misalignment capability. Corrosion-resistant and non-magnetic, they provide electrical isolation, absorb shock and isolate vibration while dampening resonance. Available beam-style servo couplings are stainless steel set-screw couplings which feature the flexibility of a bellows coupling plus the torsional stiffness and strength of a disc coupling.



Ideal for high-speed applications up to 10,000 rpm, beam-style servo couplings are corrosion-resistant, have zero backlash and a maximum torque of up to 300 lb-ft.

Bore reducers are available for use in all SureMotion drive coupling hubs to reduce bore size. The hardened stainless steel split-collar design provides 25 percent greater holding power than standard split collars.

**For more information:**

AutomationDirect  
Phone: (800) 633-0405  
[www.automationdirect.com](http://www.automationdirect.com)

# DieQua offers more gearboxes

## Are You Selecting The Right Technology?

Whether your application is for precise motion control or for general power transmission, there are several gear technologies that can do the job. But which one does it best?

Only DieQua offers the widest range of gearmotors, speed reducers and servo gearheads along with the experience and expertise to help you select the optimal solution to satisfy your needs.

If you are using gearboxes,  
you should be talking to DieQua!

**DIEQUA**  
Corporation  
[www.diequa.com](http://www.diequa.com) 630-980-1133

### Power Transmission Solutions

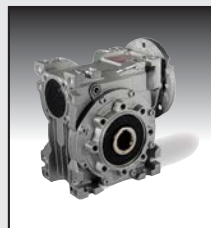

Worm Reducers

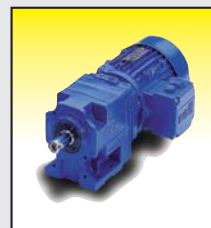

Helical Gearmotors



Spiral Bevel Gearboxes

### Motion Control Solutions



Planetary Gearheads



Servo Worm Gearheads



Precision Cycloidals

# Ringfeder Tschan TNR Couplings

DESIGNED FOR WIDE RANGE OF RIGIDITY

Unlike commonly used, torsionally elastic shaft couplings, the Tschan TNR is adjustable and therefore allows for a smoother start-up. This new, non-shiftable coupling made by Ringfeder Power Transmission is not only ideal for compressors, pumps, generators and crushers, but it is also suited for all fields of power generation using combustion engines, such as emergency power aggregates and mobile generators. Describing the challenge, Norbert Telaar, strategic product manager, said, "When selecting power transmission couplings, we often had to make compromises if a very involved design preceded it." Given this observation, his team came up with the idea of developing a coupling that would allow for the rigidity to be adjusted within a wide range.

When internal combustion engines, such as frequently used diesel engines, are employed, the power train is subject to dynamic stimuli. The actual dynamic behaviour can be plotted mathematically by joining mass moments of inertia, damping and rigidity. When the excitation frequency and the natural frequency coincide, resonance is inevitable. By changing the mass moments of inertia and specifically adjusting the rigidity of the coupling, these resonances can be moved from service speed into the non-critical range.

What makes the Tschan TNR special is that the parameters of the coupling can be adjusted within a wide range, while its outer dimensions remain the same. The coupling becomes "adjustable" because the elastic buffers are separated from one another and, as a result, are ordered in series. This simply requires a smart combination of available elastomers on an inner and an outer buffer plane, respectively. You no longer have to compromise over setting the torsional-vibration behaviour. By employing Tschan TNR, the properties of couplings can be adjusted dynamically with little effort.

## For more information:

Ringfeder Power Transmission  
Phone: +(49) 6078-9385-0  
[www.ringfeder.com](http://www.ringfeder.com)

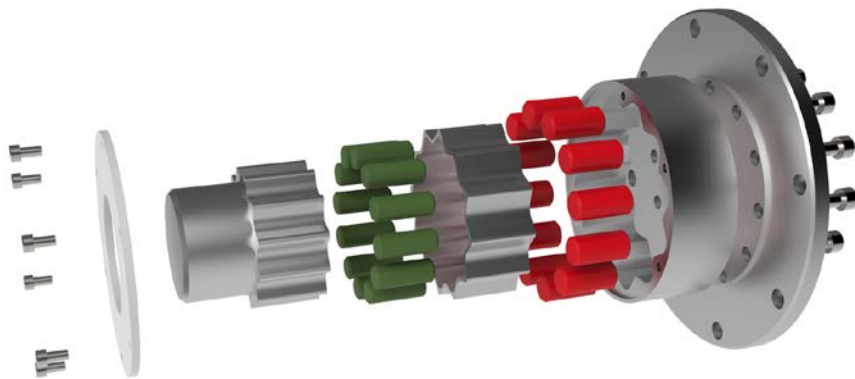

## EXCEL-LENCE AT WORK

# LARGE GEAR GRINDING? WE'RE FASTER!

**Time is money.** With our new high speed, high accuracy continuous generating grinding capability using multi-thread wheels, we're grinding gears as large as 1200 mm in diameter and module 12 much faster and more efficiently than form grinding.

We're more flexible too, with the same new platform offering rough and finish profile grinding and on-board dressing and inspection.

We also excel at grinding gears as small as 2.00" in diameter.



**Ready to Excel?  
Contact:**



815.623.3414 / [www.excelgear.com](http://www.excelgear.com)



“Whatever the mind can conceive and believe the mind can achieve.” *Napoleon Hill*

“The Secret” is really no secret.

- Mechanical Components and Assemblies
- Made to Print Parts
- Design & Engineering

*Nordex, Inc. the best kept secret...*

**Shop Nordex.com**

sales@nordex.com  
 eng@nordex.com  
 (800) 243-0986  
 (203) 775-4877

## Haydon Kerk

EXPANDS LINEAR ACTUATOR SERIES

Haydon Kerk Motion Solutions has expanded its 15000 Series linear actuators with the addition of the smallest linear actuator in Haydon Kerk’s extensive stepper motor line. The new linear actuators occupy a minimal 0.6" (15mm) diameter space and incorporate some of the most-advanced motion control technology available today. Included in that very small package are numerous patented innovations that provide customers high performance and durability.

15000 Series linear actuators are available in two designs—captive and external linear versions—and in a wide variety of resolutions, ranging from 0.02 mm to 0.10 mm per step. The actuators deliver thrust of up to 60 oz (1.7 kg) without compromising long life or cost. Models can also be micro stepped for even finer resolution. A proprietary manufacturing process that incorporates engineering thermoplastics

in the drive nut and a rolled stainless steel lead screw allows the motor to be highly efficient and durable.

Typical applications include medical equipment, semiconductor handling, valve control, X-Y tables, handheld instruments, and many more. In addition to standard configurations, Haydon Kerk Motion Solutions can custom design the actuators to meet specific application requirements.

**For more information:**

Haydon Kerk Motion Solutions, Inc.  
 Phone: (800) 243-2715  
[www.haydonkerk.com](http://www.haydonkerk.com)



## Fenner Drives RotoShield GTL

PROVIDES DEFENSE AGAINST TORQUE OVERLOADS

Fenner Drives recently announced the launch of RotoShield Gearbox Torque Limiters. RotoShield GTL stops damage from costly torque overloads before it occurs by instantly disengaging components and automatically resets with 360 degrees rotation. The unique

compact design mounts directly to the motor and gearbox for easy installation with no additional design or machining required.

“RotoShield GTL Torque Limiters give you a new way to think about protecting your equipment from torque overloads,” said Jeremy Bigler, product manager—metal products, Fenner Drives. “RotoShield is designed to mount between your motor and high efficiency reducer.

RotoShield GTL allows for easy design and installation with a more compact design at a more economical price point than torque limiters installed on the output of the reducer.”

**For more information:**

Fenner Drives  
 Phone: (717) 665-2421  
[www.fennerdrives.com](http://www.fennerdrives.com)





# Nord Drivesystems

OFFERS VL HEAVY DUTY SPREAD BEARING DESIGNS

Nord offers several variations of the VL heavy duty spread bearing designs, all which have specific features and advantages based on the specific mixing and agitating application requirements.

The first variation, VL2, offers reinforced output shaft bearings with increased bearing distance. This spread bearing design accommodates for high overhung thrust loads and allows for longer bearing service life. Included with the VL2 design is a grease-fitting for the lower bearing and a removable plug to allow excess grease to purge from the bearing cavity.

The VL3 dry cavity design adds additional oil leak protective measures to the VL2 spread bearing design. Nord's Quadralip sealing system prevents oil from leaking from the gearbox into the VL2 flange. If oil does happen to leak past the Quadralip seals, it flows down to an oil slinger mounted onto the shaft. As the shaft rotates, the oil will sling off into the dry cavity. A sight tube is provided in order to monitor the dry cavity.

VL2/VL3 with the addition of a drywell. While most drywell designs simply have a small oil dam tube inside the gear unit, Nord's stationary oil dam tube extends vertically above the top of the gear unit housing. This provides a much higher degree of leak safety. Additionally, there is a sealing o-ring at the top of the oil dam for maximum protection.

## For more information:

Nord Drivesystems  
Phone: (608) 849-7300  
[www.nord.com](http://www.nord.com)



The final variation is the VL4 heavy duty drop bearing design with a drywell. This true drywell design provides the high capacity bearing design of the

## HOW DO I KNOW IF I'M TALKING TO AN ENGINEER OR A SALESMAN?



**Ask Smalley.** It's simple to tell when you work with Smalley. That's because you'll always collaborate directly with our world-class team of engineers—experts whose only focus is helping you get the most performance from your precision wave springs or retaining rings.



Smalley Wave Spring

Coil Spring

Smalley wave springs reduce spring operating height by 50%, saving space and weight, fitting tight radial and axial spaces. We offer more than 4,000 stock sizes in carbon and stainless steel.

Visit [smalley.com](http://smalley.com) for your no-charge test samples.



THE ENGINEER'S CHOICE™

McINNES  
ROLLED RINGS

EXPECT MORE



Fast Quoting



Exceptional Product Quality



On-Time Delivery



"I'll get your quote within 4 hours."

Brandy - Inside Sales Associate

Our team is committed to keeping our promises and ensuring your complete satisfaction from inquiry to delivery.

Learn more at [McInnesRolledRings.com/ExpectMore](http://McInnesRolledRings.com/ExpectMore)

1.800.569.1420

## Miki Pulley Couplings

ABSORB VIBRATION WHILE ALLOWING HIGH MISALIGNMENT

Miki Pulley is introducing their new Bellowflex Couplings for direct sale to OEM's in North America. These couplings absorb vibration while allowing for a high degree of angular misalignment.

Bellowflex Couplings have a unique design that combines a polymer resin bellows with aluminum hubs for high performance in machine applications involving vibration and misalignment. Allowing angular misalignment up to 10°, the coupling's bellows element provides robust elasticity and high damping performance with minimal backlash.

Bellowflex Couplings are suitable for stepper motor and encoder applications providing radial flexibility. They reduce reaction forces such as side loads on shaft bearings and seals that can be caused by shaft misalignment. The polymer bellows allows parallel, angular and axial shaft misalignments while maintaining constant transmission of torque and angular velocity.

They provide a low weight/low inertia solution and are designed with high strength, zero backlash aluminum hubs with corrosion resistant socket head cap screws for ease of installation.



These couplings handle shaft speeds from 5,500 to 9,000 rpm depending on model selected.

Especially important, the Bellowflex electrically insulating bellows prevents electrical current from passing between the system shafts through the coupling. These couplings operate well in applications where temperatures range from 20° to 60° C.

Available in three sizes, with a bore range of 3 mm to 18 mm, Bellowflex Couplings can be utilized in printing, packaging, inspection, automation and similar systems.

### For more information:

Miki Pulley US  
Phone: (800) 533-1731  
[www.mikipulley-us.com](http://www.mikipulley-us.com)

## J.W. Winco

RELEASES STAINLESS STEEL FORK HEADS

J.W. Winco, Inc. now offers GN 71752 stainless steel fork heads, plain fork type, in inch sizes. These RoHS-compliant fork heads are mainly used with pneumatic or hydraulic cylinders. They are made of stainless steel, European Standard No. 1.4301 (American Standard Series 304). Standard and left hand thread types are both available. A steel version is also sold by the company.

J.W. Winco offers an extensive selection of inch and metric size adjustable levers, cabinet U-handles, plastic and steel hinges and locking mechanisms, revolving and retractable handles,



hand wheels, hand cranks, tube connection and conveyor components, inch and metric construction tubing, shock absorption mounts, leveling mounts, hand knobs, spring, ball and indexing plungers, jig, fixture and fastening components, retaining magnet assemblies, toggle clamps, metric

# ABB IRBT 2005

ACCOMMODATES RAPID PRODUCT CHANGES

ABB has introduced the IRBT 2005, a flexible, compact and modular medium track motion platform for both robots and transfer applications. It is designed to accommodate rapid product changes in applications that require an extended working range and high degrees of speed and accuracy, including arc welding, material handling, machine tending, and sealing and dispensing.

The IRBT 2005 is available with up to two carriages as a robot track, with additional carriage plates available to carry any necessary process equipment, and up to three carriages as a transfer track. The modular design is comprised of one-meter lengths that can be connected to form a track between two and 21 meters, allowing it to easily be adapted to different applications and evolve with changing production needs.

The ABB IRC5 controller runs the robots and the IRBT 2005 together as one dynamic model, with the proprietary QuickMove and TrueMove functionalities providing fast acceleration and precise path accuracy in any given track configuration. It offers high speed and precision accuracy, providing greater flexibility and up to 50 percent shorter cycle times.

## For more information:

ABB  
Phone: (248) 391-9000  
[www.abb.com/robotics](http://www.abb.com/robotics)



# IDC SELECT®

## Quality Products. Right Price. Right Now.



**IDC Select® products  
are available at hundreds  
of independent distributor  
locations across  
North America**

casters and wheels, universal joints, oil sight glasses, and metric tools for the industrial and commercial equipment industries. J.W. Winco's website catalog, with 3D CAD and online buying, is viewable at the website below.

## For more information:

J.W. Winco, Inc.  
Phone: (800) 877-8351  
[www.jwwinco.com](http://www.jwwinco.com)



[IDCselect.com](http://IDCselect.com)



# Mix and Match Mechatronics

## Smart technology thrives in heavy industrial market

Matthew Jaster, Senior Editor

### Mechatronics simplifies traditional engineering concepts across most industrial segments.

By combining mechanical, electrical and computer technology into a single, integrated solution, products become systems that are more efficient, reduce operator error and cost less to manufacture.

“There is a significant trend in heavy industry to migrate away from hydraulic systems towards electromechanical types. In the right application, electromechanical systems can offer many benefits such as reduced energy consumption and/or energy regeneration, accurate and repeatable positioning, safety and predictive maintenance solutions,” said Richard Hansen, senior automation engineer at Bosch Rexroth.

The mechatronics field is becoming more relevant as engineers blur the lines between mechanical and electrical engineering solutions. “There was very little talk of mechatronics in general manufacturing 20 years ago,” said Craig Hooker, director BU Production Machinery, NA at Schaeffler. “Now the push toward Industry 4.0 and the Industrial Internet of Things (IIoT) has made these integrated concepts more of an engineering necessity moving forward.”

### Bosch Rexroth Adapts, Reacts and Integrates

So how are mechatronic solutions being applied in heavy industry today? “Electromechanical systems offer great control of machine function. Our linear drive components can achieve positioning accuracies in the single digit micron range when coupled to Bosch Rexroth motors and drives,” Hansen said. “These motors and drives use sophisticated acceleration profiles that can incorporate jerk for smooth starts and stops when required.”

This type of functionality yields greater control in heavy industrial applications that move large masses, ac-

ording to Hansen. “Greater control gives the user better quality at every step of production by allowing for data capture of all critical aspects of machine function. This data can be very useful for predicting and preventing product defects before they hit the market and/or predicting when machine maintenance is required (another asset for quality assurance).”

Bosch Rexroth has recently developed a Heavy Duty Electromechanical Cylinder (EMC-HD). This cylinder mimics the size and shape of certain traditional hydraulic types but incorporates highly efficient ball or planetary roller screws to produce thrust



Assembly of the EMC-HD. Notice the size of the belt side drive and motor on the right hand end of the actuator that is on the table behind the one being worked on! The scale of this actuator in relation to the workers in this shot helps emphasize the heavy duty nature of the product and large magnitude of forces it can handle. All parts shown are supplied by Bosch Rexroth.

Precision and rigidity are a must in today's heavy machine industries. Bosch Rexroth roller rail and ball screw components offer best in class capacity and durability; helping builders keep up with customers' ever increasing demands and push the traditional limits of machine capabilities. This is well evidenced by this vertical machining center example; where the demand of a large scale overhung payload must be supported and controlled.

forces up to 290,000 N. When coupled to a Bosch Rexroth servomotor, drive and control, the benefits previously mentioned are all achievable. "Having an electromechanical solution that can achieve forces historically reserved only for hydraulic solutions is proving highly desirable to many customers," Hansen explained.

Operating costs in heavy industrial applications are a significant factor. "These systems only use energy when there is demand for use and can also allow for the recapturing of energy into a reserve bank for future use. We've all heard of regenerative braking used on hybrid cars; this is essentially the same



There was little talk of **MECHATRONICS** in general manufacturing 20 years ago. Now the push toward Industry 4.0 and the Industrial Internet of Things (IIoT) has made these integrated concepts more of an engineering necessity moving forward."

concept applied to industrial equipment. Energy that would typically be lost in a form of heat is recaptured and reused, saving costs for the machine owner," Hansen said.

Another benefit that comes to mind is the flexibility of the system. "Servo controls allow the system to be easily adapted on the fly within a flexible manufacturing cell or it can be repurposed to fit a new application once the original design application's life has ended," he added.

Safety plays another key role in mechatronic design. When a full Bosch Rexroth mechatronics solution is offered, the customer can rely on the Safety On Board features of the servo drive. Bosch Rexroth's Safe Torque and Safe Motion are just two examples and allow the machine programmer to enable different safety protocols depen-

dent on the trigger that can protect the operator, the equipment and the product itself. "Ensuring the safety of the machine operator is always the top priority, but if this can be done while still ensuring the integrity of the machine and material it is of great benefit to the customer by reducing downtime and scrap material costs," Hansen said.

Currently, Bosch Rexroth is seeing a lot of potential in offering customers subassemblies that may range from a simple single axis linear actuator to a multi-axis robot. "Many of our customers run lean organizations and often their expertise is in the complete machine solution, not necessarily the motion systems that lie within. We offer design and build services of linear motion and assembly components that complement our customers' resources."



### Schaeffler Doubles Down on Mechatronic System

Schaeffler has two focused areas in mechatronics including actuation and sensorized bearings. The thrust of this changing technology is blending different engineering disciplines together to create more efficient systems. "Due to the limitations of hydraulic systems, we're expanding our product line to include designs that offer high load carrying capacity and a high power densi-

ty," Hooker said. "Our planetary screw drive PWG is one example of this."

Screw drives include a threaded spindle and a threaded nut. Due to the rotation of the spindle, the nut moves in a linear manner on the spindle and thus converts the rotary motion of the drive into linear motion. It is rigidly connected to the adjacent construction and gives axial displacement or positioning of the component. The main load direction of screw drives

is axial, but radial load is not permissible. The screw drive can be subjected to high dynamic axial load.

Schaeffler's PWG screw drives are characterized by a very high performance density. Force is transmitted via the flanks of the rollers, spindle and nut. Due to the large number of contact points, a very high axial load carrying capacity is achieved. Due to the very small pitch values, high axial operating forces can be achieved with small drive units (without a gearbox).

The PWG generates 2,200 N of axial force from only 40 Ncm with an overall pitch of 0.75 mm. Consequently, very high axial forces can be achieved even with small motors. Schaeffler's PWG makes it possible not only for actuators driven by electric motors with a high power density, long rating life, and low maintenance outlay to be developed, but also for low-cost motors to be used. The electric drive can be easily integrated using a feather key connection on the outside diameter of the spindle nut.

The applications for the PWG include solar power, wind power, sheet metal forming, sheet metal bending machines, locking cylinders for plastic injection molding machines, riveting



[www.circlegear.com](http://www.circlegear.com)

**Circle Gear and Machine**

1501 South 55th Ct. • Cicero, IL 60804  
Ph: 708-652-1000 • Fax: 708-652-1100

**WE'VE EXPANDED!**



**EQUIPMENT PURCHASES**

- Luren LFG-8040 Verticle Gear Profile Grinder
- Gleason 463 spiral/hypoid gear tooth grinder

**FACILITY**

- Purchased 77,000 sq ft building, expanding to 122,000 sq ft

**STRATEGIC PLANS**

- Continued growth in spiral bevel/hypoid marketplace
- Expand gearbox service and overhaul business

**GEARBOX REPAIR SPECIALISTS**

- Prompt, accurate quotations
- Competitive pricing
- Quality repairs/rebuilds

**Quality Reducer Service**

1501 South 55th Ct. ■ Cicero, IL 60804  
708-354-8080 | FAX: 708-652-1133

**QUALITY REDUCER SERVICE**

WE SERVICE ALL TYPES OF INDUSTRIAL GEARBOXES

[www.qualityreducer.com](http://www.qualityreducer.com)



Schaeffler's torque sensor technology is already being utilized in certain agriculture applications.

and cutting devices, and in adhesive metering systems. The PWG is already in volume-production use in clutch actuators for the automotive industry.

On the bearing side, Schaeffler offers an intelligent roller bearing solution that measures lubrication status, wear particles, temperatures, vibration, force, torque and speed. "Different modules can do different things," Hooker said. "We're able to apply sensors right where the torque is being transmitted as a bearing is often the central part of the machine design."

This torque sensor technology is already being used in agricultural machinery. Fertilizer spreaders, for example, include FAG torque measurement units integrated directly into the drive hub. They accurately measure the actual fertilizer flow during the spreading process using contactless technology. Clogging and blockages at the dosing gate can be identified. "A similar application would be the distribution of salt on icy roads," Hooker added. "Here, the torque sensor can give the driver a more accurate measurement of the salt needed to adequately cover the road without creating more waste."

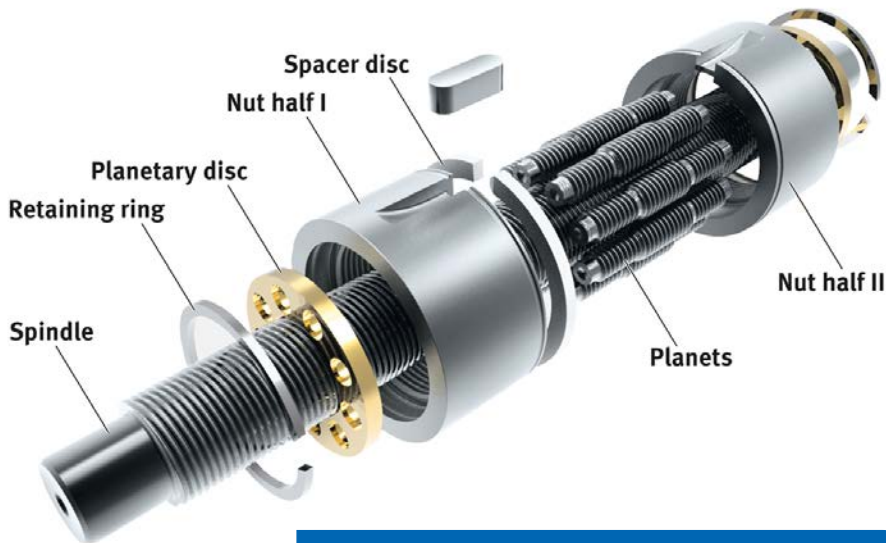

In the Schaeffler planetary screw drive (PWG) design, the spindle and planetary gears are manufactured using forming methods.

For Related Articles Search

mechatronics

at [www.powertransmission.com](http://www.powertransmission.com)

# INNOVATIVE RACK & GEAR



Gear rack specialists with state-of-the-art gear rack production capabilities including our most recent acquisition; Gleason-Saikuni HR-2000 CNC rack milling machine with hard-milling after heat treat capabilities up to 65 Rc hardness (producing impressive tooth finishes and accuracies comparable to rack grinding).

We will happily demonstrate samples produced for the most demanding of needs in aerospace, automation, off-highway equipment, defense, energy, machine tool, medical and others.

- Custom SPUR and HELICAL racks from a variety of materials
- Precision Quality up to AGMA 12
- Unique Tooth Configurations
- FINE and COARSE pitch (254 D.P. – 0.5 D.P.; 0.10 Module – 50 Module)
- Hard-cut up to 65 Rc and soft-cut up to 40 Rc
- 32" Face width and up to 288" lengths through resetting
- Prototype & Production quantities
- Breakdown Service Available
- Reverse Engineering
- Heat Treating & Plating
- Complete CNC Machining



**630.766.2652**

fax: 630.766.3245

**[www.GEARACKS.com](http://www.GEARACKS.com)**

[info@gearacks.com](mailto:info@gearacks.com)

365 Balm Court, Wood Dale, IL 60191

## Mechatronic Applications with SKF

Jean-Pierre Collognat, linear and actuation technology business leader at SKF, also described planetary roller screws as some of the newest mechatronic technology for heavy industrial applications. "These planetary roller screws are built into electro-mechanical linear actuation in conjunction with high torque electric motors," he said. "They offer high load carrying capacity and long service life for heavy duty applications. SKF's latest generation of Ultra Power roller screws provide a load carrying capacity increased by 60 percent versus traditional planetary roller screws. Ultra Power roller screws advantageously replace hydraulic cylinders in industrial grade applications, with the additional benefits of energy savings, precision and flexibility of electric controls."

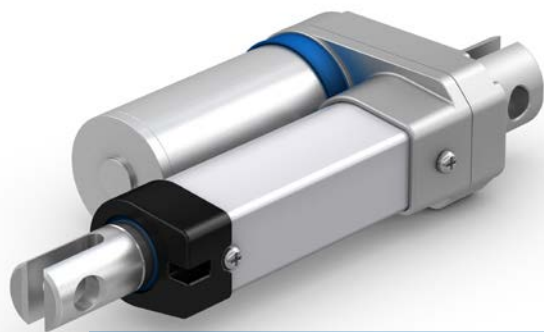

SKF electromechanical actuator CAHB family features robust metal gears and corrosion-resistant housings.

Mechatronic solutions are advantageous for several reasons in heavy industry, according to Collognat. "Some of these include a general trend toward increased energy efficiency and environmental consciousness, lower total cost of ownership and improved functionality." The benefits for considering mechatronic solutions vary by industry.

Collognat discussed particular industrial segments where mechatronic solutions would offer significant upgrades to older equipment or individual components:

**Plastic Injection Molding:** Energy efficiency, cleanliness, productivity.

**Broaching:** Electro-mechanical machines offer greater flexibility for producing various parts (easier change-over.) EM solution offers higher machine stiffness, constant acceleration and speed, resulting in higher accuracy and better part surface finish. Tool life is greatly increased. EM broaching machines have a smaller footprint and present lower environmental risks.

**Stamping presses:** Better stamping force control, for greater part accuracy.

SKF's LEMC is a modular electromechanical cylinder that consists of a linear unit, motor adapter, limit switch and motor and controller.

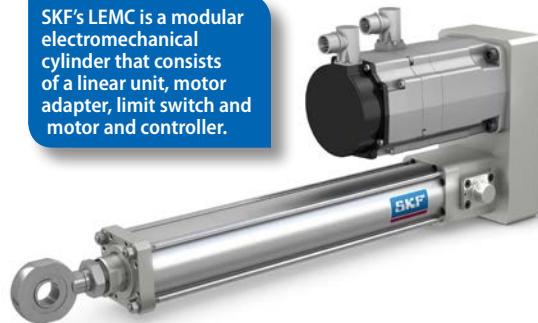

**Assembly presses:** Full control of the assembly process, with force and displacement monitoring as well as the recording of process parameters in real time.

**Factory automation:** Many industries striving for the fluid-free factories. Motivations to look for electro-mechanical solutions: Energy efficiency, Total Cost of Ownership, flexibility, preciseness, functionality, controllability, productivity, speed, noise reduction, safety, reliability, reduced maintenance, space saving.

**Oil & Gas:** Customer motivations: EM solutions ease of use, controllability, environmental impact, response time (example closing a subsea valve is way easier with an EM solution than running a hydraulic line,) safety, compactness (down-hole tools), reliability.

## Taking the Next Step

The role of online mechatronic design and simulation will make huge strides in the next decade, according to Hansen at Bosch Rexroth. It is common to see online model configurators with all automation component suppliers. The trend and demand will continue for these suppliers to offer their potential customers design and simulation services directly on their website.

"This not only allows the customer to build a 3D model, but also develop motion simulation right there to easily allow the engineer to determine if the product meets the application's needs. This may not be only a graphical representation, but could ideally result in real programming that can be utilized

for commissioning once the physical system arrives at the customer's site. Many robotic suppliers already offer this type of solution. This type of offering can also prove invaluable when presenting and communicating the intended solution, before any components are purchased, with the end user to ensure all parties understand and recognize the application needs," Hansen said.

Collognat at SKF believes mechatronics for industrial grade applications will experience an annual growth rate around 10 percent based on various figures in IMS reports. "More industries will embrace the environmental benefits of EM technology and total cost of ownership will go down with

increased competition, reduced costs of servo technology, etc," he said.

Hooker at Schaeffler said the interest in mechatronics continues to evolve. "I don't think we're going to see any earth shattering changes in mechatronic applications, I think we'll see small incremental changes that will make industrial systems smaller, more efficient and easier to use." **PTE**

### For more information:

Bosch Rexroth  
Phone: (800) 739-7684  
[www.boschrexroth.com](http://www.boschrexroth.com)

Schaeffler Group USA, Inc.  
Phone: (803) 548-8500  
[www.schaeffler.us](http://www.schaeffler.us)

SKF USA Inc.  
Phone: (267) 436-6000  
[www.skf.com](http://www.skf.com)



# Brands YOU Count on, People You Trust

Lubriplate® PGO-FGL-460 is a 100% polyalkylene glycol (PAG) synthetic high performance fluid. It is designed for lubrication of worm gears. PGO-FGL-460 is NSF/H-1 registered food grade lubricant and meets ISO-460 and SAE-140 requirements. It meets the specifications of the leading gear reducer OEMs which require synthetic fluids. This product is not compatible with mineral oils and other hydrocarbon fluids.

And, you can find **Lubriplate** gear oils at your local **Motion Industries** location. Our local sales and service specialists are experts in application and technical support, providing the parts and know-how you need to stay up and running.



Scan this code with your smartphone for more information

<http://esp.to/w953BY>



The brands you count on from the people you trust...that's Lubriplate and Motion Industries.



**Call.** 800-526-9328  
**Click.** [www.MotionIndustries.com](http://www.MotionIndustries.com)  
**Visit.** Over 550 Locations



Over 550 locations | More than 5.6 million products | Industrial maintenance training courses

©2016 Motion Industries, Inc.

# Two-stage Helical Bevel Gearing

## Offers Alternative to Three-Stage Helical Bevel Gearboxes and Worm Gearing

Randy Summerville, Siemens Industry, Inc.

**Gearing is an essential component in conveyors.** The material handling industry appears divided between those who favor high-end three-stage helical bevel gearboxes and those who rely on less expensive worm gearing. But there's an often over-looked alternative, the two-stage helical bevel gearbox.

Two-stage helical bevel gearing offers significant benefits to both OEMs and end-users by lowering costs at both initial purchase and over the lifetime of equipment. With one less stage, and thus fewer components, compact two-stage helical bevel gearboxes are smaller, lighter and less expensive than three-stage helical bevel gearboxes with equal or greater output torque and speed.

An even lesser known fact is that two-stage helical gearmotors are often no more expensive than helical worm gearmotors. In addition to having a longer life, they also consume less energy in operation than either worm gears or three-stage helical bevel gearboxes. For any application beyond intermittent duty, this translates into substantial savings over the long term.

### Energy efficient gains

Whether you're using helical, bevel or hypoid gearing, each gearing stage experiences approximately a two percent energy loss due to friction in the gears, bearings and lubricant. With one less stage, two-stage helical bevel gears de-

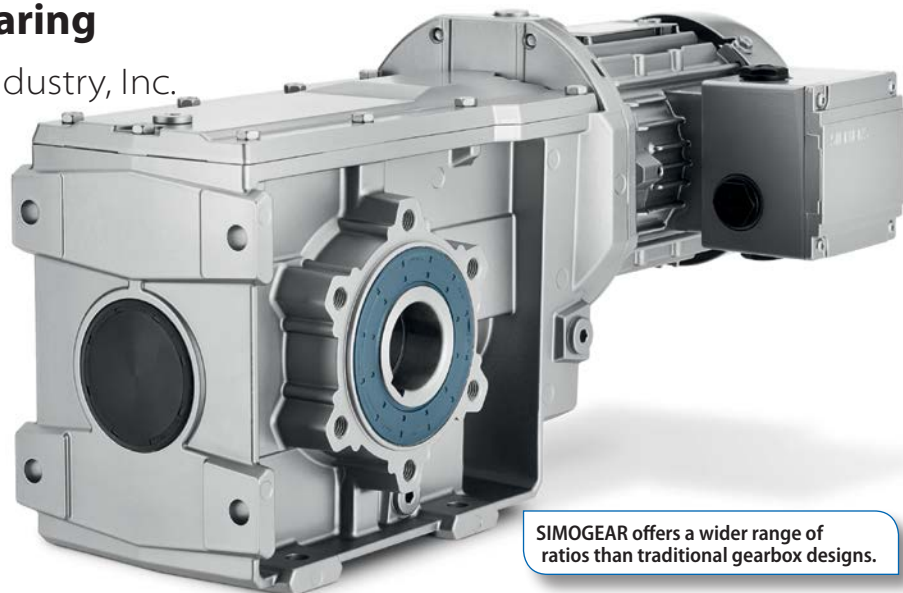

SIMOGEAR offers a wider range of ratios than traditional gearbox designs.

liver an automatic two percent gain in energy efficiency over three-stage units.

A cost analysis of 200 gear units in a typical industrial setting over five years shows that using helical bevel gearing instead of helical worm gearing would save over \$52,000, with a return on investment of less than one year.

Of course, these efficiency levels assume that equipment will be properly maintained over its lifetime. Failure to maintain bearings and oil quality can increase friction and thereby decrease energy efficiency even in the best gearing designs.

### Designed for productivity

Although product ranges can vary by supplier, Siemens SIMOGEAR two-stage helical bevel gearboxes can handle input power of 10 hp. That makes them suitable for the majority of conveyor systems.

Since the motor pinion of a SIMOGEAR motor is in the form of a plug-in

**W**hile the automotive and baggage handling segments have mostly shifted to three-stage helical bevel gearing, much of the parcel handling, distribution warehousing and bottling industries often still use energy-hogging worm gearing.

or shank pinion, a wider range of ratios is possible than with traditional designs. SIMOGEAR units have ratios as low as nearly 3:1, allowing engineers the cost advantage of using standard four-pole motors, even in high-speed applications.

### Benefits for OEMs

Engineered to provide greater torque density in a smaller package, the SIMOGEAR B series two-stage helical bevel unit means fewer parts and smaller, lighter-weight aluminum housings. This makes them easier to hold and work with when assembling machines, translating into faster machine builds and less worker fatigue. The compact footprint not only contributes to their affordability, it makes them easier to incorporate into modern, streamlined machine designs.

2-stage vs. 3 stage helical bevel gear motors.

	Helical bevel gear motors 2-stage (B Series)	Helical bevel gear motors 3-stage (K Series)
Efficiency	Up to 96%	Up to 94%
Output torque (lb-in)	442 to 3,982	1,947 to 14,160
Ratio	3.47 to 59.28	5.17 to 244.25
Motor power (HP)	1/3 to 10	1/3 to 20



**WE ARE**  
UNDER PRESSURE TO  
BE FIRST IN AUTOMOTIVE  
INNOVATION—PRESSURE  
WE WELCOME! IMTS  
FUELS GENERAL MOTORS  
WITH INSPIRATION & IDEAS,  
DRIVING OUR CURIOSITY  
TO NEW DESTINATIONS.

# WE ARE

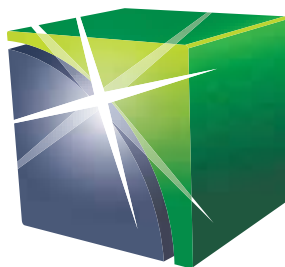

**PREPARED.**

## IMTS2016

International Manufacturing Technology Show  
September 12 - 17, 2016 · McCormick Place · Chicago

register now at [imts.com](http://imts.com)

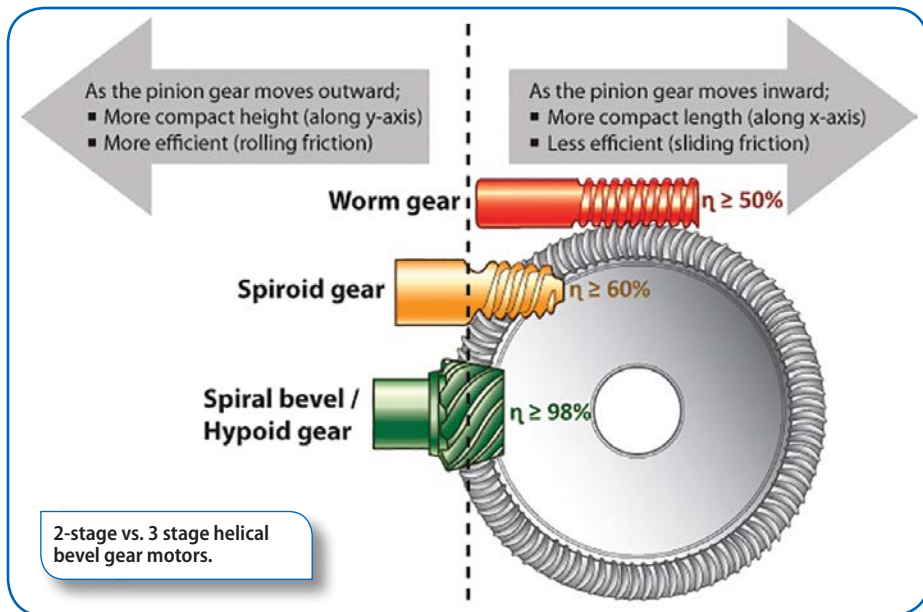

Just as important is their initial affordability, which is often at or near the same price point as the inefficient worm or spiroid gearing long favored by cost-conscious OEMs. The significant energy efficiency gains when moving from worm to helical bevel gearing also mean you may be able to use a smaller motor in the same application. Given the high cost of motors, this provides another benefit to OEMs.

- Efficiency
- Output torque (lb-in)
- Ratio
- Motor power (hp)

**An even lesser known fact is that two-stage helical gearmotors are often no more expensive than helical worm gearmotors. In addition to having a longer life, they also consume less energy in operation than either worm gears or three-stage helical bevel gearboxes.**

The ability to achieve the same performance with lower energy costs is a particularly important advantage for OEMs involved in export markets where electricity costs are higher than in the United States. Even in this country, consuming less energy in a process can help end-user customers avoid high utility demand charges.

**The key to energy efficiency**

The material handling industry relies on shaft-mounted right angle gear motors to deliver the torque and power needed to move conveyors. While the automotive and baggage handling segments have mostly shifted to three-stage helical bevel gearing, much of the parcel handling, distribution warehousing and bottling industries often still use energy-hogging worm gearing.

Since the actual efficiency of any drive train can be no higher than its least energy-efficient part, it is defeating the purpose to use any component that doesn't match the efficiency of its most efficient part. Selecting variable frequency drives, motors, gearing,

couplings, controls and other drive train components with similar energy efficiency ratings assures that the end goal of reducing energy consumption and operating costs can be met.

One of the most common examples of this kind of mismatch is combining worm gears with Premium efficiency motors. In this case, the extra money spent for the efficient motor has been mostly wasted and operating cost reductions will not be as high as they could have been if the entire drive train had been evaluated.

**Why worm gears may not be your best choice**

It's important to understand that the energy efficiency of worm gears decreases as the ratio increases. Worm gear units with efficiencies of less than 70 percent are not uncommon. This means that up to 30 percent of the energy consumed by a process is wasted.

Compare that to two-stage helical bevel units, like the Siemens SIMO-GEAR B-series, which have an infinite gear life and operate at efficiencies of up to 96 percent. That means 96 percent of the energy used to produce speed and torque is actually used for that purpose.

Worm gears also require the use of larger motors to compensate for energy losses due to the friction inherent in their design. It's a case of throwing good money after bad. You're not only wasting money on energy, you're wasting it on an over-sized motor.

Worm gears wear over time due to their sliding friction design (compared to the rolling friction of helical bevel gears). Worm gears combine a steel gear with a bronze gear, a softer metal that wears more quickly than its counterpart.

Comparison of two- and three-stage helical bevel gears vs. worm gears in conveyor application.		
	Helical Worm	Helical Bevel
Initial cost for end user	\$890	\$930
Gearbox efficiency	80%	96%
Required output power	1.4 HP	1.4 HP
Required motor power	2 HP	1.5 HP
Energy cost per year	\$366/year	\$305/year

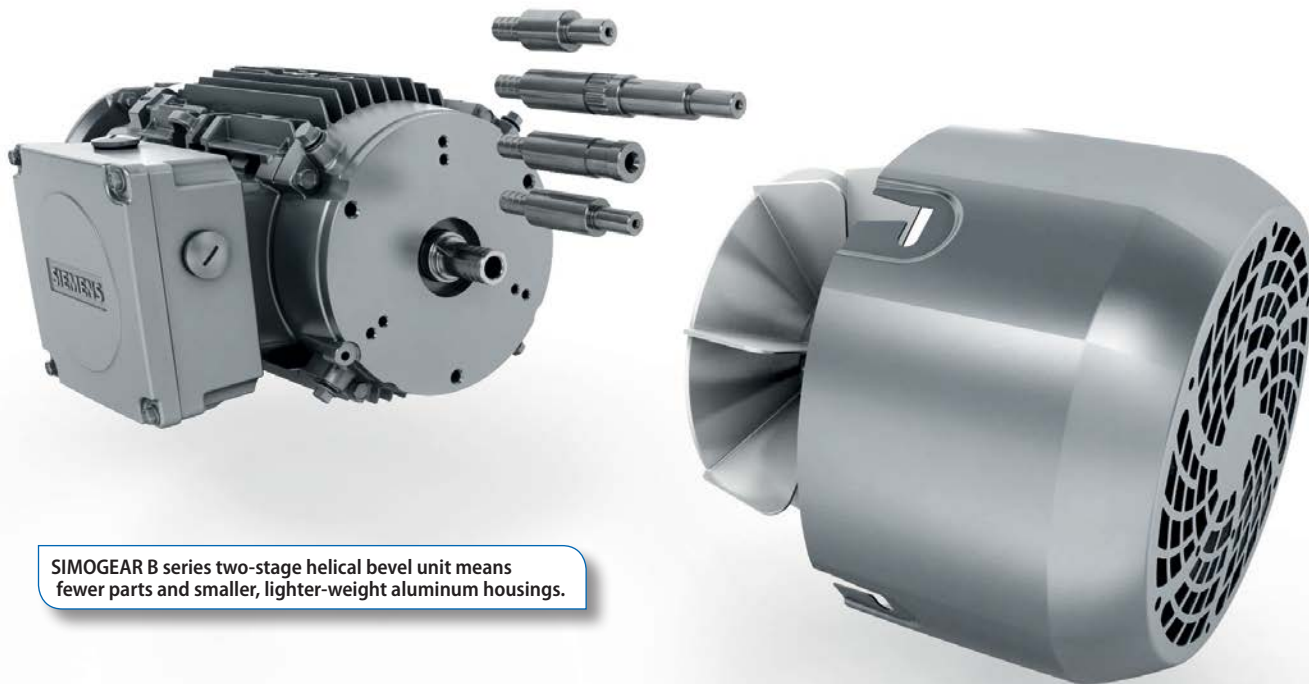

SIMOGEAR B series two-stage helical bevel unit means fewer parts and smaller, lighter-weight aluminum housings.

This sliding friction generates excessive heat, which must be removed from the environment using fans or air-conditioning to protect workers and other equipment. It also means that the bronze gears—or the entire gear unit—must be periodically replaced.

The combination of bronze particulates from worn worm gears and the heat generated by friction also means that lubricants must be changed regularly to prevent bearing damage and to keep gear wear to a minimum. And since critical maintenance is often skipped, these units typically have an even shorter life than expected.

All told, the economic disadvantages of worm gears in non-intermittent duty applications far outweigh any initial savings on the purchase price for both OEMs and their customers.

### Improving margins

The two-stage helical bevel gearbox is a major advance in gearing technology that is poised to deliver significant benefits to the material handling industry by reducing the energy and maintenance costs of conveyor systems. With its proven economic benefits, this innovative design is gaining traction with both OEMs and end-users.

- Initial cost for end user
- Gearbox efficiency
- Required output power
- Required motor power
- Energy cost per year

Material handling equipment that incorporates an energy-efficient drive train utilizing the most efficient mechanical and electric components can ensure a more reliable, cost-effective and productive operation. It's a win-win scenario for both OEMs and end-users. **PTE**

### For more information:

Siemens Corporation  
Phone: (800) 743-6367  
[www.usa.siemens.com/simogear](http://www.usa.siemens.com/simogear)

### Randy Summerville is

products marketing manager, SIMOTICS Motion Control Motors, Siemens Industry, Inc. He has more than 20 years' experience in system sizing, system selection, and operation of adjustable speed drive equipment for various applications in industries of machine assembly, plastic finishing and process automation. He has a bachelor's degree in electrical engineering (Kansas State) and a master's degree in business administration (Brenau University).

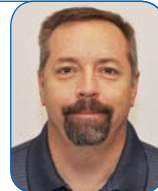

For Related Articles Search

gear drives

at [www.powertransmission.com](http://www.powertransmission.com)

# Reducing Food Processing Plants' Energy Costs

## High efficient washdown motors make a dramatic impact

Cheryl Higgins, Leeson Electric

**U.S. manufacturers, such as food processors, face an unprecedented competitive environment and must look for ways to be profitable without negatively affecting the quality of finished products.** The challenge of maintaining high product quality while simultaneously reducing production costs can often be met through investments in energy efficiency, which may include the purchase of energy-efficient technologies like high-efficiency motor systems.

According to the Department of Energy (DOE), electric motor-driven systems are estimated to consume more than half of all electricity in the U.S. and more than 70 percent of all electricity in food and beverage manufacturing applications. These processing plants are large users of energy for refrigeration, cooking, heating, boilers and steam generation, sterilizing, conveyors, and auxiliary equipment. However, because energy is typically viewed as peripheral to the business of production, efficiency projects have an uphill fight for capital and attention. Even if organizations adopt a more holistic approach to energy, managers and engineers often don't have the time to analyze payback from various projects and prioritize them. But this should be one of the first places to look for reducing costs, and improving productivity and profits.

### Food Processing Industry and Energy Consumption

The typical industrial plant in the U.S. can reduce its electricity use by around five to 15 percent by improving the efficiency of its motor-driven systems. Process manufacturing has the highest absolute consumption of electricity, 419,587 gigawatt hours per year, and motor systems account for fully 71 percent of this total. A significant challenge in promoting high-efficiency motors is that motor buyers often misunderstand where the costs of motor ownership lie, and therefore do not account for these costs accurately. The greatest cost of motor ownership is that of operating the motor, which represents 97-98 percent of lifetime costs. Initial purchase price represents only an estimated two-three percent.

### Energy Efficient Systems

Electric motors used in production facilities with conveyors are almost always on, driving the energy bill higher. But what if there was a way to reduce energy consumption and costs while increasing the efficiency level? There is; through the use of high-efficient motors. Energy efficient motors make economic sense: In an industrial application operating 4,000



hours/year, energy-efficient motors earn back their initial cost in two years.

### Upgrade Incentives

Many state organizations and energy companies have created monetary rebate programs available to qualifying businesses. For example, the Wisconsin Food Processing Plant and Food Warehouse Investment Credit is a refundable tax credit for businesses that have invested to modernize or expand food processing plants or food warehouses in Wisconsin and who have been certified by the Wisconsin Department of Commerce.

Tax credits are earned by incurring eligible expenses for modernization or expansion of a food processing plant or food warehouse. This includes constructing, improving or acquiring buildings or facilities, or acquiring equipment for food processing or food warehousing.

Wisconsin also has the Meat Processing Facility Investment Credit program to support the modernization of the state's meat processing industry. The tax credits build on the success of the state's dairy modernization and investment tax programs. The program provides a tax credit for up to 10 percent of the expenditures meat processors invest in modernization or expansion. Eligible costs include construction, additions, utility upgrades, equipment, technology and other upgrades.

In southern Indiana, Dubois REC and other local rural electric cooperatives, in a partnership with Hoosier Energy, have created a monetary rebate program for energy efficient upgrades. Local electric cooperatives have been offering rebates on energy efficiency upgrades through Hoosier Energy since 2009. For a comprehensive listing for your state's incentives, please visit: <http://businessfacilities.com/2015/04/food-processing-facts/>

## Food Processing Plant Sanitation

According to a 2011 U.S. Centers for Disease Control and Prevention estimate, 48 million Americans get sick, 128,000 are hospitalized, and 3,000 die annually from food borne illnesses. The costs associated with contaminated food are staggering.

Food processing equipment poses some unique challenges for maintenance personnel. Wet operating conditions and wash-down requirements can require specially-designed equipment. This has become critical since the passage of the Food Safety Modernization Act in 2011. However, one way food processing companies can reduce food borne illnesses and costs is to use stainless steel food safety motors.

These motors don't have crevices where bacterial build-up can start. They are steam and/or waterproof for cleaning-in-place and other demanding wash-down regimes. This is particularly important because when plant personnel take a pressure hose and clean the machine, they don't care if it's a motor, a cable or a drive, they just want it clean according to industry standards. There is no way of efficiently washing a machine.

Specially engineered stainless steel motors also don't have a need for paint that could flake into the food, hold in moisture and hide corrosion. They are of "Totally Enclosed, Not Ventilated" (TENV) design, which means that they do not have a fan and fan cover, which are both difficult to clean and could be the breeding space for bacteria. When selecting a motor upgrade in this industry, it's important to check that the motor is USDA and FDA approved, BISSC Certified, or a motor with IP55 enclosure protection.

## Smithfield Foods Reduces Downtime and Expenses

From small town beginnings in Smithfield, Virginia, Smithfield Foods has grown into a \$14 billion global food company with a presence in 12 countries and is the world's largest pork processor and hog producer. The Virginia-based pork company derived its ham from a curing process Native Americans taught settlers five centuries ago. Based in the farming heartland of the United States, Smithfield Foods International delivers consistent quality pork across six continents. The company's global commitment is the same one held in the U.S. since 1959—to bring the goodness of America's farmland and second-to-none quality to every plate, every time.

All facilities are certified by a third party to the ISO 14001 Environmental Management System Standard. Farmland Foods was the first meat processing company to have all meat processing and livestock facilities certified to this particular standard.

Millions of dollars are invested each year in capital improvements to facilities and equipment to increase product safety and protect employees while enhancing production. Since 2011, Smithfield Foods has spent more than \$5.6 million on projects dedicated to food safety and quality issues, including upgrading motors in processing plants.



## Maintaining Sanitation

Food processing plants are a very difficult environment for motors due to the daily cleaning and sanitizing of equipment. Harsh chemicals like sodium hydroxide and other caustics are used to clean equipment and can be extremely corrosive. Not only are caustic chemicals used, high pressure spray is used, sometimes up to 1000 psi with the nozzle held a few inches away from the motor. This ensures all contaminants are removed from the equipment.

Plant downtime emergencies divert limited maintenance personnel and disrupt production at the cost of thousands of dollars per hour. A major consideration in maintenance is food safety. It's very important to get the meat processed quickly and correctly the first time to get it to the consumers. To help reduce downtime because of burned out motors, food processing facilities, such as Smithfield Foods' Denison, Iowa and Sioux Falls, S.D., plants are installing stainless steel washdown motors.

In compliance to the Food and Drug Administration (FDA), these motors are made entirely of stainless steel, including the bases, conduit box covers, fan covers, and bands. The food-grade model consists of materials and lubrication that are food-safe.

This type of motor is suitable for use in the food industry, or in any other applications where motors are commonly exposed to moisture, humidity and specific chemicals that cause corrosion. With the help of washdown motors, flexibility and durability are enhanced, which can yield to minimal operating expenses while increasing uptime.

Previous to installing washdown motors, equipment at these plants used standard motors, which couldn't hold up to the severe chemicals and high-pressure hose washdowns. These motors were being changed out every three to four weeks — amounting to approximately 800 motors at each of these two facilities annually.

"We're always striving to eliminate downtime during production, and cut back on maintenance time and expense," said Diann Loosmore, purchasing information analyst Smithfield Strategic Sourcing & Services Co. Inc. "Replac-

ing all painted, standard motors with stainless encapsulated motors allows for far greater reliability, particularly in these extreme conditions.”

Key factors in the motor selection included application specificity, longevity and maintenance.

“These new motors are easy to install, easy to maintain, and they last,” added Loosmore. “In fact, in certain applications at the Sioux Falls plant some of the motors have been in service for over a year.” The company is so pleased with the motors’ performance and reliability that they are installing them in all of their U.S. facilities.

Sources for this article include the following: [www.iac.rutgers.iau](http://www.iac.rutgers.iau), [www.cggc.duke.edu](http://www.cggc.duke.edu), Ibid and [http://web.applied.com/base.cfm?page\\_id=4176](http://web.applied.com/base.cfm?page_id=4176). **PTE**

#### For more information:

Leeson Electric  
Phone: (262) 377-8810  
[www.leeson.com](http://www.leeson.com)

**Cheryl Higgins** is product marketing manager with Leeson Electric and may be reached at (262)387-5275 or [cheryl.higgins@leeson.com](mailto:cheryl.higgins@leeson.com). Regal Beloit Corporation (NYSE: RBC), based in Beloit, Wisconsin (USA), is a global leader in innovative solutions that convert power into motion for customers in industrial, commercial and consumer markets around the world. The company is comprised of three business segments: Climate Solutions, Commercial and Industrial Systems and Power Transmission Solutions. For more information, visit [RegalBeloit.com](http://RegalBeloit.com).



### Motor Design Offers Proprietary Shaft Seal

The new Extreme Duck ULTRA motor is engineered with distinct features making it a suitable motor for use in the food processing, pharmaceutical, packaging and beverage industries. The new design ensures that liquids don’t penetrate the motors in any mounting position and the motor is easier to install and connect because of unique colored leads.

A proprietary shaft seal that underwent a year of testing — 8,760 hours — is one of the motor’s unique features. Other features include lead wires that are *non-wicking*, and colored and numbered for easy identification during installation. Additionally, the motor is installable in all mounting positions, has standard dual voltage and dual rotation, an all stainless steel exterior and a corrosion resistant coating is applied to the rotor. Further exclusive features of the include a new encapsulation process with better materials that ensure complete filling of the motors and curing of the epoxy encapsulation, the nameplate information is permanently etched into the frame, the conduit box on TEFC motors rotates 360 degrees, and an Inverter Duty IRIS insulation system.

Each motor is 100 percent pressure tested before leaving the plant to ensure it is completely sealed to prevent the ingress of liquids. The motor meets the Energy Independence Security Act mandate going into effect June 1, 2016.

The benefits of the Next Generation Extreme Duck Motor include numbered lead wires that enable easier readability and identification, reducing installation time and costs. The extensive pressure testing guarantees liquids don’t penetrate the motor, which increases motor life and virtually eliminates plant down time. The elimination of corrosion ensures a longer motor life and lessens operating costs. Additionally, washdown motors enhance flexibility and durability, yielding to minimal operating expenses while increasing plant uptime.

This motor is designed for use in food processing and other applications where motors are exposed to frequent washdown, common cleaning and sanitizing chemicals, and high humidity. Washdown motors provide durability and flexibility to help maximize uptime and reduce overall operating costs in these and many other demanding applications where general purpose motors will not survive. “By listening to customers’ feedback we designed this next generation motor with distinct features making it an ideal motor for use in the food processing, pharmaceutical, packaging and beverage industries,” said Steve Bernhardt, Leeson Electric lead application engineer. **PTE**



For Related Articles Search

motor efficiency

at [www.powertransmission.com](http://www.powertransmission.com)



## Engineering sMart

is your resource for the latest in great ideas from our advertisers. Check this section every issue for sMart Engineering ideas and technology.

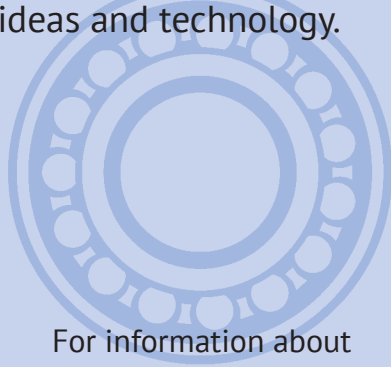

For information about advertising, contact Dave Friedman

at

**(847) 437-6604**

or

[dave@powertransmission.com](mailto:dave@powertransmission.com).

## Power Transmission & Linkage Components



Scan to see these products

J.W. Winco offers power transmission components as part of its immense offering of standard machine components for industry. Explore our full line on our website [www.jwwinco.com](http://www.jwwinco.com) or contact us with your application requirements.

2815 S. Calhoun Road  
New Berlin, WI 53151  
Phone: 800-877-8351  
Fax: 800-472-0670  
Sales@jwwinco.com



**J.W. WINCO, INC.**

## Economical Helical Speed Reducers

The Varvel RD series provide heavy duty performance in a light-weight package.



- Diecast aluminum housing
- 5 sizes 0.25 - 25 HP
- NEMA or IEC dimensions
- Unique coupling input
- Interchangeable with competitors

**DIEQUA**  
Corporation

[www.diequa.com](http://www.diequa.com)

630-980-1133

## High Performance Bevel Gearboxes

The Tandler spiral bevel is ideal for precise motion control, high speed, high torque, or heavy shock.



- 9 sizes
- 15 ratios
- Low backlash
- Customizable

**DIEQUA**  
Corporation

[www.diequa.com](http://www.diequa.com)

630-980-1133

**Nordex**  
INCORPORATED

Over 32,000 standard components.

Buy online 24/7.

[Nordex.com](http://Nordex.com)

# Counterfeit Consequences

## Do You Know the Difference Between Fake and Genuine Bearings?

*Power Transmission Engineering* is collaborating with the Bearing Specialists Association (BSA) on a special section within the magazine. *Bearing Briefs* will present updated reports on bearing topics for each issue in 2016. Complimentary access to all BSA Bearing and Industry Briefs is available on the BSA website at [www.bsahome.org/tools](http://www.bsahome.org/tools). Additionally, our new Field Notes section on page 34 will feature field reports from BSA's Certified Bearing Specialists.



*We build relationships*

Think counterfeit bearings don't matter? Think again. The old adage "If it looks like a duck, swims like a duck, and quacks like a duck..." does not apply to bearings. Just because a bearing may look like the real thing, that doesn't mean it is genuine OE quality. Fakes can appear indistinguishable from the original, but they don't always perform like the genuine article. A seller of fake bearings: can be held liable for all damage resulting from the sale of counterfeit bearings; can face lawsuits by the injured party; cannot seek legal redress from the OEM; could face heavy fines and/or even go to prison. So, what can you do to avoid selling counterfeit bearings? Make sure you buy only genuine, trademarked products from the brand owner/original manufacturer.

The consequences of using a fake bearing can range from minor annoyance to expensive downtime or warranty costs to... disaster. Buying a cheap "Rulex" watch from a street vendor can be a fun conversation-starter at a party. Installing a fake bearing that fails prematurely in a critical position inside a machine, however, can cost lives. Fake bearings can jeopardize your business, threaten your bottom line and even put you, your employee's or customer's life at risk. When you use

fake bearings, you risk damage to your machinery, higher maintenance costs, unplanned downtime and work stoppages. You also risk your company's image and reputation if your product fails and risk injury to yourself, your employees and/or your customers. Always check with the manufacturer if you have doubts about whether your bearing is the genuine item. BSA builds relationships. The Bearing Specialists Association (BSA) is the forum to enhance networking and knowledge sharing to promote the sale of bearings through authorized distributors (visit [www.stopfakebearings.com](http://www.stopfakebearings.com) to learn more). BSA Membership encompasses authorized distributors as well as participating manufacturers. Many of the educational tools and resources developed by BSA are available on the public BSA website, accessible to both members as well as end users. **PTE**

### For more information:

Bearing Specialist Association (BSA)  
[info@bsahome.org](mailto:info@bsahome.org)  
[www.bsahome.org](http://www.bsahome.org)

For Related Articles Search

bsa

at [www.powertransmission.com](http://www.powertransmission.com)



# The Only Coupling To Earn Its Wings



**BALDOR • DODGE**

The NEW patented Baldor • Dodge® Raptor takes coupling innovation to greater heights. Utilizing a patented winged element design for higher bond strength and improved fatigue resistance, the Raptor delivers:

- Longer driven equipment life and increased reliability
- Easier installation and reduced maintenance
- Drop-in interchangeability

The Raptor is backed by over 50 years of natural rubber expertise and an industry leading 5-year warranty. Expect a higher level of reliability with the new Baldor • Dodge Raptor coupling.

**baldor.com 479-646-4711**



*Raptor's slotted clamp rings offer more clearance at the bolt holes for an easier installation than competitive designs.*

**BALDOR**  
A MEMBER OF THE ABB GROUP



Download a QR reader app  
and scan this code for  
more information.  
[www.baldor.com/dodgeraptor](http://www.baldor.com/dodgeraptor)

# Identifying Bearing Failure

## Certified Bearing Specialist (CBS) Takes on Lime Quarry's Harsh Environment

Guy Gendron, certified bearing specialist and technical sales representative at Timken Canada L.P. explains how he used his bearing expertise to increase a customer's productivity.

"Working for a bearings manufacturer, we are often asked by our distributors to visit end users who experience bearing problems, to examine them and find potential solutions.

I visited a lime quarry, which had several unplanned bearing replacements, causing production interruptions. My goal was first to identify the cause of the bearings failures and identify the customer expectations, such as improving time in operation, better maintenance practice, guidance on bearing installation, etc.

A lime quarry is a very harsh environment for bearings; limestone is very abrasive. I found out that the type of bearings causing production interruption were mostly spherical self-aligning double row bearings installed in split cap housing (plummer block). Several conditions were found, contamination of the lubricant due to seals wearing out from the abrasive stone, mounting procedure of the taper adapter on the spherical bearings had to be reviewed and several bearings were mounted with a RIC too tight. Several pillow blocks were installed in hard-to-reach areas, which made the bearing adjustments hard to do on site.

The end user was looking for an easy-to-install pillow block, having the load capacity for the application, with a better protection against the harsh conditions. Not requiring any structural modification on his part, in other words, being dimensionally similar to the existing plummer block.

I was able to offer them a Spherical Roller Bearing Solid Block pillow block with the same principal dimensions as the plummer block, using the same sized spherical double-row self-aligning bearing, having features such as an extended inner race on which the seals are sitting, having the seal in contact with the inner race of the bearing versus having the seal in contact with the equipment shaft as the plummer block design improved seal life and does not damage the shaft, the Timken unit uses a triple lip self-purging urethane seal which has a ten times better resistance to abrasion versus the standard nitrile seal material, for ease of installation we use the double V-lock locking system, thus avoiding using a filler gauge to adjust the RIC and you cannot over tighten the bearing. For extra protection, we installed auxiliary covers fill with grease to create a barrier against contaminants. The installation of this type of pillow block also reduces the downtime.

In conclusion, by finding out the customer priorities, inspecting the damaged bearing to find out the reason of the failure, we were able to replace the SNL22520 × 3<sup>7</sup>/<sub>16</sub> TG with a Timken QV-VPN20V307SO with cover CV20T307S. We more than tripled the life of the bearing." **PTE**

### For more information:

Bearing Specialist Association (BSA)  
[info@bsahome.org](mailto:info@bsahome.org)  
[www.bsahome.org](http://www.bsahome.org)



**BSA's Certified Bearing Specialist (CBS)** program is the only bearing industry-specific program that identifies and quantifies the specific skill sets to certify an industry professional as a bearing specialist. The CBS program is all about developing the expertise to help customers and end users make the best bearing decisions. Take advantage of this complimentary access to a Certified Bearing Specialist. Please email your question to [info@bsahome.org](mailto:info@bsahome.org). An expert CBS will respond to your inquiry and it may appear in this article.

**Guy Gendron**, CBS and technical sales representative at Timken Canada LP, is a seasoned specialist in bearings and power transmission, having worked in this industry for more than three decades. Over the length of his career, he has worked for distributors and manufacturers at various levels of sales and management.



For Related Articles Search

bearing failure

at [www.powertransmission.com](http://www.powertransmission.com)

# RELIABLEPLANT 2016

CONFERENCE & EXHIBITION

APRIL 5-7  
2016  
LOUISVILLE, KENTUCKY

## ATTEND. LEARN. APPLY.



More than 80 Exhibitors



75+ learning sessions and still growing



Discover solutions that you can implement right away

Don't miss insightful case studies from these industry leaders...



### New Methods and Better Reliability in Three Days

The 17th annual *Reliable Plant Conference & Exhibition* is more than just 75+ sessions featuring new ideas and real-world case studies. *Reliable Plant 2016* gives you new maintenance strategies and methods your staff will understand and support.

**76% of surveyed attendees said they were able to make changes in their workplace within three months of attending**, and half of them were already seeing results. So whether you're interested in pre- and post-conference workshops, networking opportunities, certifications or browsing dozens of exhibitors, join us in Louisville, Kentucky, to see what's waiting for you.

#### What You'll Get With Registration:

- Admission to all conference sessions
- Conference proceedings
- Opening general session and keynote address
- Exhibition hall access
- Daily breakfasts, refreshments and lunches
- Networking receptions
- **FREE** Noria training coupon, valued at \$1,295

[Conference.ReliablePlant.com](http://Conference.ReliablePlant.com)

CALL (855) 209-9924 TO REGISTER & SAVE \$200!

DISCOUNT UNTIL MARCH 3, 2016



# Homogeneous Geometry Calculation of Arbitrary Tooth Shapes: Mathematical Approach and Practical Applications

Maximilian Zimmer, Michael Otto and Karsten Stahl

This paper provides a mathematical framework and its implementation for calculating the tooth geometry of arbitrary gear types, based on the basic law of gear kinematics. The rack or gear geometry can be generated in two different ways: by calculating the conjugate geometry and the line of contact of a gear to the given geometric shape of a known geometry (e.g., a cutting hob), or by prescribing the surface of action of two gears in contact and calculating the correspondent flank shapes. Besides so-called standard gears like involute spur and helical gears, bevel or worm gears, it is possible to analyze the tooth geometry of non-standard gears (e.g., non-involute spur, conical, or spiroid gears). Depending on the type of gear, a distinction is made between tool-dependent and tool-independent geometry calculation.

As an extensive machine element to transfer and convert rotational movement, gears meet high requirements for construction and assembly. Due to existing modern production techniques, more sophisticated gear types can be produced with high precision and maintainable financial effort. The benefits of traditional gear profiles, such as an involute, are thus no longer of major importance. In particular, for gear types such as bevel, worm, and hypoid gears, but also for non-standard gear types (e.g., beveloid gears, crown gears, or spiroid gearings), modern gear production systems ensure high quality and reliability to the operator. Depending on the context of application, different gear types have advantages and disadvantages concerning load carrying capacity, effectiveness, or noise excitation. Supported by various calculation software tools for the particular gear type, it is possible to create the optimal gear design, depending on the respective application. A homogeneous calculation software for ubiquitous gear geometries—irrespective of the gear type, and especially for analyzing non-standard gears—would be preferable. This paper provides a mathematical framework and its implementation for calculating the tooth geometry of arbitrary gear types, based on the basic law of gear kinematics. The rack or gear geometry can be generated in two different ways: by calculating the conjugate geometry and the line of contact of a gear to the given geometric shape of a known geometry (e.g., a cutting hob), or by prescribing the surface of action of two gears in contact and calculating the correspondent flank shapes. Besides so-called standard gears like involute spur and helical gears, bevel or worm gears, it is possible to analyze the tooth geometry of non-standard gears (e.g., non-involute spur, conical, or

NOMENCLATURE		
Symbol	Description	Unit
$a$	center distance	mm
$b$	face width	mm
$C_\beta$	lead crowning	$\mu\text{m}$
$d$	reference diameter	mm
$d_b$	base diameter	mm
$d_{(F)a}$	(utilized) tip diameter	mm
$d_{(F)f}$	(utilized) root diameter	mm
$m_n$	normal module	mm
$m_t$	transverse module	mm
$m_x$	axial module	mm
$u$	gear ratio	-
$x$	addendum modification coefficient (profile shift)	-
$z$	number of teeth	-
$\alpha_n$	normal pressure angle	$^\circ$
$\beta$	helix angle	$^\circ$
$\gamma$	worm pitch angel	$^\circ$
$\Delta$	gear rotation angle for uniform motion transfer	$^\circ$
$\Delta_x$	local gear rotation angle for non-uniform motion transfer	$^\circ$
$\dot{\Delta}$	gear angular velocity	$^\circ/\text{s}$
$\eta$	worm swivel angle	$^\circ$
$\theta$	addendum modification angle (cone angle)	$^\circ$
$\Theta$	auxiliary angle for calculating parallel sections worm profile	$^\circ$
$v$	translational rack velocity	mm/s
$\varphi$	arbitrary rotation angle	$^\circ$
$\psi$	tool displacement angle (beveloid manufacturing process)	$^\circ$
$\Sigma$	axis crossing angle	$^\circ$
$a_i$	axis point vector	
$b_i$	axis directional vector	
$c_i$	arbitrary vector	
$n_i$	outer unit normal vector	
$x_i$	vector of point of contact	
$x$	vector of circumferential velocity	
$y_i$	vector / surface / point cloud of a tooth shape	
$A, B, C$	scalars to simplify formulas of conjugate gearing	
$D_b(\varphi)c$	rotation function of vector c around axis b by angle of j	
$\tau$	face width parameter of beveloid/cylindrical gears	
$\sigma$	profile parameter of cylindrical gears	
1	index of gear 1 respectively index of rack	
2	index of gear 2 respectively index of work piece	
0	index of tool (e.g. grinding worm or hob)	

Printed with permission of the copyright holder, the American Gear Manufacturers Association, 1001 N. Fairfax Street, Fifth Floor, Alexandria, VA 22314-1587. Statements presented in this paper are those of the author(s) and may not represent the position or opinion of the American Gear Manufacturers Association.

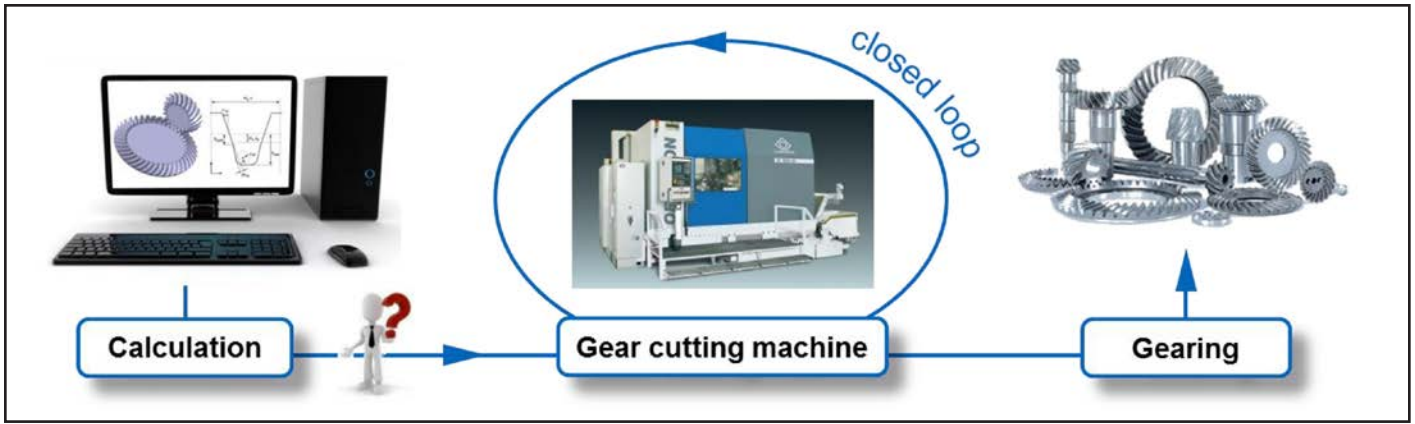

Figure 1 Process chain for an optimized integrated calculation and manufacture of arbitrary gears (Graphic courtesy Klingelnberg GmbH).

spiroid gears). Depending on the type of gear, a distinction is made between tool-dependent and tool-independent geometry calculation. The described mathematical algorithms are summarized in implemented software modules for the particular gear types. Two practice-oriented examples are presented to illustrate the calculation model: beveloid gears for use in vehicle or marine gear boxes as well as rack-and-pinion meshing with variable ratio, as it is used for steering systems on automobiles. Since the geometry is exported as a point cloud, a further analysis of the generated gear types is possible, e.g., by computer-aided design or finite-element software tools as well as manufacturing on 5-axis CNC or forging machines. Thus, a detailed analysis—especially of non-standard gears—is feasible that currently cannot be calculated and evaluated with common industrial gear calculating software. The project is funded by the Forschungsvereinigung Antriebstechnik e.V. (FVA).

### Motivation

Gears are complex machine elements designed to transfer and convert rotational or translational movement. Engineers face high requirements in construction and assembly to design gears that reach proper function, in particular with regard to cost effectiveness and sufficient load capacity.

Due to existing modern production techniques, more sophisticated gear types can be produced with high precision and maintainable financial effort. Thus, the benefits of traditional gear profiles—such as an involute—are no longer of major importance. Especially for non-standard gear types—beveloid gears, face gears or spiroid gearings, for example—modern gear production systems ensure high quality and reliability to the operator. The tooth shape geometry of these gears has a significant impact on the competing goals of efficiency, load capacity, and noise excitation. To achieve an optimized gear profile, depending on the respective application, it is inevitable that production needs to be supported by high-performance calculation software.

Therefore, it is necessary in the first design step to develop a uniform mathematical framework for an integrated calculation of arbitrary gear types in any axis position. The algorithms should be able to provide any kind of three-dimensional tooth geometry fast and analytically. The main focus is the computation of practice-oriented gears with regard

to the concrete manufacturing kinematics of a gear cutting machine. Besides, the potentials of new gear shapes can be tapped without the restriction of a common manufacturing machine. By numerical generation of the gear shape via point cloud, further analyses are possible, e.g., by computer-aided design or finite-element software tools, in addition to manufacturing on 5-axis CNC or forging machines.

To sum up: a fast and analytical uniform calculation method and its implementation would help to support the integrated gear design and generation process of any kind of gearings (Fig. 1).

### Mathematical Fundamentals of Tooth Geometry Calculation

Starting from the fundamental demand for a continuous uniform motion transfer with constant gear ratio  $u$ , all mathematical principles can be described by the basic law of gear kinematics for conjugate shapes. In particular, this means that the angular velocity  $\Delta_{1,2}$  of both gears is directly proportional to the number of teeth  $z_2/z_1$ :

$$\frac{z_2}{z_1} = \frac{\Delta_1}{\Delta_2} = u \quad (1)$$

To keep the flanks staying in contact, the vector of relative motion of both flanks has to be perpendicular to the outer unit normal vector. Otherwise, the touching flanks would pass through each other or lose contact. That means, in particular, that the normal velocity of both flanks has to be commensurate in any point of contact. Gear 1 is mounted on axis  $a_1 + \lambda \cdot b_1$  and gear 2 on axis  $a_2 + \mu \cdot b_2$ . The basic law of gear kinematics becomes (Ref. 1):

$$0 = \langle n_i, x_1 - x_2 \rangle = \left\langle n_i, \left( b_1 \times (x_1 - a_1) - \frac{z_1}{z_2} \cdot b_2 \times (x_1 - a_2) \right) \right\rangle \quad (2)$$

with the point vector  $a_i$  and directional vector  $b_i$ . In Equation 2,  $x_i$  is the contact point of both flanks. Therefore, Figure 2 shows schematically the relations of the basic law of gear kinematics for gear-gear meshing.

As the basic law of gearing is defined, we are now able to calculate the conjugate flank to a given shape. Starting from a given surface parametrization  $y_1$  (or computed point cloud, such as a 3-D measurement of a gear) with the corresponding outer unit normal vectors  $ny_1$ , we first rotate the given shape

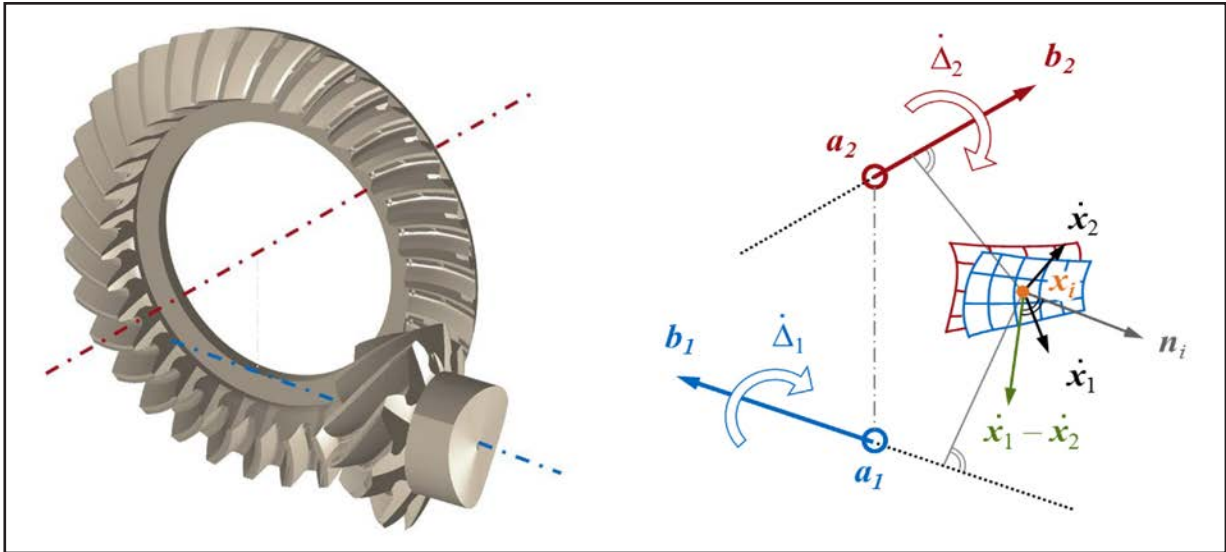

Figure 2 On the basic law of gear kinematics for gear-gear meshing.

by the (so far unknown) angle  $\Delta$  to solve Equation 2. The rotated point thus becomes the current point of contact

$$x_1 = x_2 = a_1 + D_{b_1}(\Delta)(y_1 - a_1) \tag{3}$$

$D_{b_i}(\varphi_i)c_i$  denotes a rotation of vector  $c_i$  by the angle  $\varphi_i$  around axis  $b_i$  (Ref. 1). The desired shape  $y_2$  can be computed by rotating the point of contact  $x$  around the axis of gear 2 by the angle of  $-\Delta z_1/z_2$ :

$$y_1 = a_2 + D_{b_2}\left(-\Delta \cdot \frac{z_1}{z_2}\right)(x_1 - a_2) \tag{4}$$

The angle  $\Delta$  to solve Equation 2 is presented by (Ref. 1):

$$0 = A + B \cos \Delta + C \sin \Delta \tag{5}$$

with the scalars (Ref. 1):

$$A = \langle n_{y_1}, b_1 \times (y_1 - a_1) \rangle - \frac{z_1}{z_2} \langle n_{y_1}, b_1 \rangle \cdot \langle b_1, b_2 \times (a_1 - a_2) \rangle + \frac{z_1}{z_2} \langle b_2, b_1 \rangle \cdot \langle b_1, n_{y_1} \times (y_1 - a_1) \rangle$$

$$B = \frac{z_1}{z_2} \cdot \left( n_{y_1} - \langle n_{y_1}, b_1 \rangle \cdot b_1, b_2 \times (a_1 - a_2) \right) + \langle b_2 - \langle b_2, b_1 \rangle \cdot b_1, n_{y_1} \times (y_1 - a_1) \rangle$$

$$C = \frac{z_1}{z_2} \cdot \left( \langle n_{y_1} \times b_1, b_2 \times (a_1 - a_2) \rangle + \langle b_2 \times b_1, n_{y_1} \times (y_1 - a_1) \rangle \right) \tag{6}$$

We solve Equation 5 by usage of the *arctan2*-function:

$$\Delta = \arctan2(y, x) \text{ with co-domain } \pi < \arctan2(y, x) \leq \pi$$

and the arguments  $(y, x)$  (Ref. 1)

$$(y, x) = \left( -A \cdot C \mp B \cdot \sqrt{B^2 + C^2 - A^2}, -A \cdot B \pm C \cdot \sqrt{B^2 + C^2 - A^2} \right) \tag{8}$$

As the algorithms have to be implemented in a selected computer language, the purpose of using two arguments in the *arctan2*-function instead of one is to return the appropriate quadrant of the computed angle, which is not possible for the single-argument *arctan*-function (Ref. 2). It can be easily seen that Equation 5 has two solutions in which the solution with  $\min \|\dot{x}_1 - \dot{x}_2\|$  is the one preferred for practice-oriented gear shapes (Ref. 1).

As mentioned in the opening, another generation method calculates a conjugate pair of flanks from a given surface of action with definition of an initial line of contact (Ref. 1).

Since this algorithm is difficult to apply to the simulation of a gear manufacturing process (the surface of action between tool and workpiece is generally not known before the generation process, but results as an outcome of it), it is not used in the applications presented in this paper. For further information, see (Refs. 1 and 3).

Besides the meshing of two (axially symmetric) gears, gear rack engagement is relevant — especially for the generation process of cylindrical or conical gears — as well as worm gears or rack-and-pinion meshing in general. Therefore, adhering to enhancement of the basic law of gear kinematics is necessary.

The rack is given by a shape with translational velocity  $v_1$  moving in the direction of  $b_1$  (Fig. 3). The gear is rotating with angle  $\Delta_2$  around its axis  $b_2$ . With the point of contact  $x_i$  and unit normal vector  $n_i$ , the basic law for gear rack meshing becomes (Ref. 3):

$$\langle n_i, v_1 \cdot b_1 - b_2 \times (x_i - a_2) \rangle = 0 \tag{9}$$

(7) For applications such as generation of a gear by a tool shape (e.g., with a basic rack profile [Ref. 4]) we can calculate the gear shape  $y_2$  by a given rack

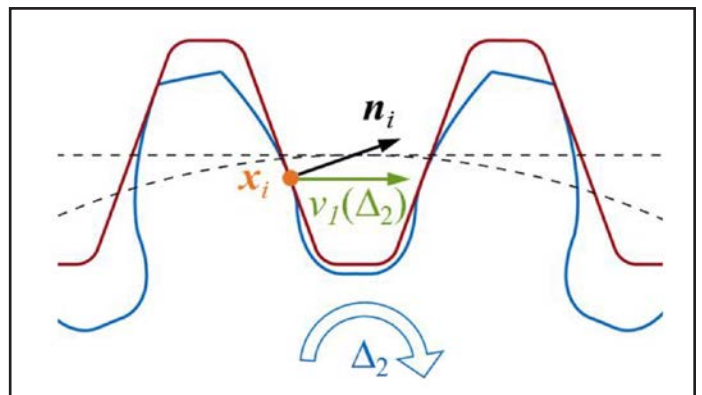

Figure 3 On the basic law of gear kinematics for gear-rack-meshing.



contour  $y_1$  (Ref. 3):

$$y_2 = a_2 + D_{b2}(\Delta)(y_1 + \Delta \cdot v_1 \cdot b_1 - a_2) \quad (10)$$

The angle  $\Delta_2$  to solve the basic law of gearing (Eq. 9) results analytically by (Ref. 3):

$$\Delta_2 = \frac{\langle n_i, b_2 \times b_1 \cdot v_1 \rangle}{\langle n_i, v_1 \cdot b_1 - b_2 \times (y_i - a_2) \rangle} \quad (11)$$

Furthermore, we can go the other way around and compute the tool geometry  $y_1$  to manufacture a given gear shape  $y_2$  (e.g., with modified, non-involute flank or root fillet contour) for optimized bending stress. To determine the conjugate rack geometry, the solution of the adapted basic law results in (Ref. 3):

$$y_1 = a_2 + D_{b2}(\Delta_2)(y_2 - a_2) - v_1 \cdot \Delta_2 \cdot b_1 \quad (12)$$

Moreover, it is possible to extend Equation 12 for non-uniform motion transfer. With  $v_1 = f(\Delta_2)$  the thus far constant ratio between rack and gear becomes a function of the gear rotation angle  $\Delta_2$  — and therefore variable. The variable, three-dimensional tooth shape of the rack can now be calculated as

$$y_1 = a_2 + D_{b2}(\Delta_x)(y_2 - a_2) - b_1 \cdot \int_{\Delta_0}^{\Delta_x} v(\Delta) d\Delta \quad (13)$$

in which  $\Delta_x$  is the angle searched for in solving the basic law (Eq. 9) subject to the rack gain  $v_1(\Delta_2)$ . The angle  $\Delta_x$  can be calculated for each point of contact by solving:

$$0 = A(\Delta_x) + B \cdot \cos \Delta_x + C \cdot \sin \Delta_x \quad (14)$$

with the scalars:

$$A(\Delta_x) = \langle n_2, b_2 \rangle \cdot \langle b_1, b_2 \rangle - \frac{\langle n_2, b_2 \times (y_2 - a_2) \rangle}{v_1(\Delta_2)} \quad (15)$$

$$B = \langle n_2, b_1 \rangle - \langle n_2, b_2 \rangle \cdot \langle b_1, b_2 \rangle \text{ and } C = \langle b_2 \times n_2, b_1 \rangle$$

Due to the fact that Equation 14 has no analytical solution,  $\Delta_x$  must be calculated by appropriate numerical methods for each “local” gear ratio  $v_1(\Delta_2)$ .

## Practical Application: Generation Process of Beveloid Gears

Beveloid gears are spur or helical gears with involute profile and variable addendum modification, realized by a cone angle  $\theta$ , thus getting tapered root and outside diameters. Beveloid gears can be used for example in automobile and marine applications with parallel, intersected or crossed axes — and in a variety of relative positions. As they can be manufactured on common involute, cylindrical gear cutting machines, beveloid gears assure a cost-effective alternative to bevel or hypoid gearsets — especially for small amounts of axis-crossing angle, say less than  $15^\circ$  (Ref. 5).

As conical gears continue gaining more and more importance in the drivetrain industry, extensive investigations have been carried out — especially on geometry, contact analysis and bending stress. Mitome et al. (Refs. 6–7) conducted theoretical and experimental research concerning design and manufacturing methods of conical involute gears. Brauer (Ref. 8), Innocenti (Ref. 9) and Ohmachi et al. (Ref. 10) derive mathematical models based on conjugate flank meshing and contact characteristics, as well as on contact analysis using geometric shapes without modifications and practice-based deviations. Zhu et al. (Ref. 11) proposed a pitch cone design theory with regard to misalignments on tooth contact behavior of crossed beveloid gears. Fuentes et al. (Ref. 12) optimized the tooth profile of beveloid gears with regard to improved bearing contact and reduced noise excitation.

The exemplarily described investigations and methods all have in common the fact that the calculated geometry is based on an idealized basic rack profile or cutting / grinding tool simulation without modifications or deviations. The three-dimensional geometry of the beveloid flanks can be computed by means of differential geometry methods, as they are documented by Litvin et al. (Refs. 13–14). A practice-oriented geometry by a cutting or grinding process will lead to deviations on the tooth flanks that in fact influence the meshing characteristics (Refs. 15–16).

An elementary, fast and analytical method to determine the three-dimensional (non-modified) tooth geometry of a conical gear is to tilt a basic rack profile (Ref. 4) via cone angle  $\theta$  (=

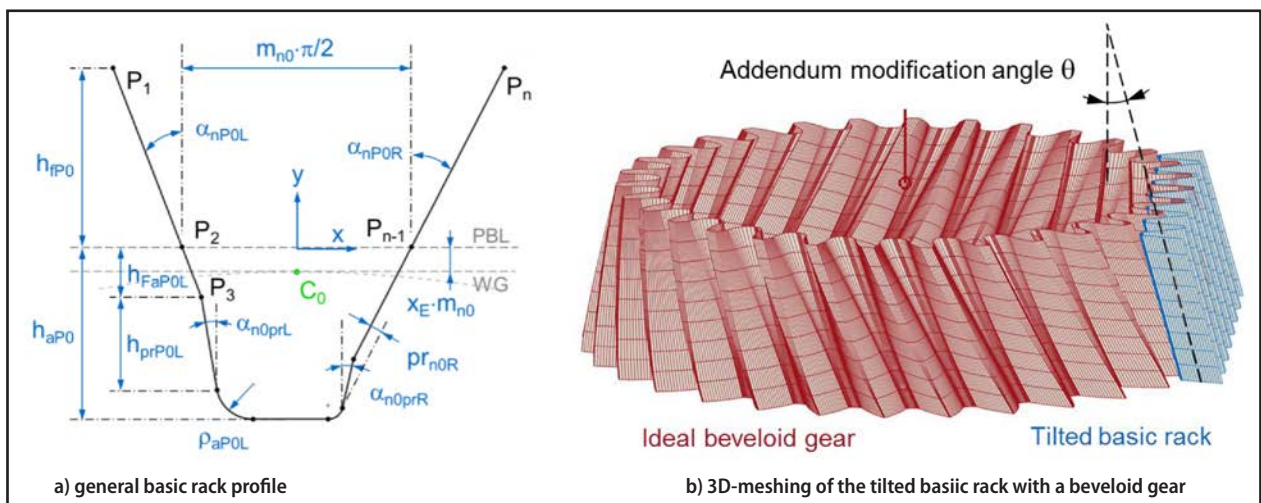

Figure 4 On the geometry calculation of non-modified beveloid gears with a tilted rack.

addendum modification angle) and appliance of Equations 9–11. Therefore the geometry of the basic rack can be parametrized in sections  $y_{p1}$  and  $y_{p2}$  with straight, polynomial and elliptic curves and the corresponding, outer unit normal vectors. To obtain the main geometric data of the conical gear, documented formula in Roth (Ref. 17) or Tsai (Ref. 18) can be used. Figure 4(b) clearly shows the calculated three-dimensional tooth geometry of a non-modified beveloid gear by a tilted basic rack profile (Fig. 4(a)). The calculated geometry does not take into account specific manufacturing deviations or modifications, as they occur in industrial practice.

Now, as we can feasibly calculate a reference geometry of a beveloid gear by a basic rack, we engage with the real manufacturing process of conical gearing.

The tool used for grinding (or cutting) is a worm with involute transverse (ZI) or straight normal section profile (ZN). All formulas to describe the main geometry of the tool are listed in DIN 3960 (Ref. 19) and DIN 8000 (Ref. 20). The geometry of the tool can be defined as an axial profile  $y_0$  in its  $y$ - $z$ -plane, exemplary for an involute worm flank as:

$$\tilde{y}_0(\lambda) = \begin{bmatrix} 0 \\ y_0 \\ z_0 \end{bmatrix} = \begin{bmatrix} 0 \\ \pm \frac{m_{x0} \cdot z_0}{2} \cdot (\tan \lambda - \lambda) \\ \frac{d_{b0}}{2 \cdot \cos \lambda} \end{bmatrix}, \lambda = \sqrt{\left(\frac{d}{d_{b0}}\right)^2 - 1} \text{ with } \frac{d_{Fj0}}{2} \leq d \leq \frac{d_{Fa0}}{2} \quad (16)$$

with axial module  $m_{x0}$ , number of threads  $z_0$ , base circle diameter  $d_{b0}$  and utilized root and tip diameters  $d_{Fj0}$  and  $d_{Fa0}$ . Further axial profiles for ZA, ZN, ZK or ZC worms can be calculated with the adapted methods of Predki (Ref. 21) and Octrue (Ref. 22), see (Ref. 3). To realize a root fillet contour, the tool tip edge is defined as a circle or elliptic arc (Ref. 3).

By definition of the axial profile, the three-dimensional geometry of the worm could be computed by screwing the axial profile along its axis to get a full parametrization. However,

the usage of the basic law of gear kinematics with Equations 2–8 would lead to line contact between worm and beveloid gear. In fact, the meshing conditions between worm and workpiece are characterized by point of contact, comparable to crossed helical gears. To realize a fast and analytical simulation anyhow, a representation of the tool in its axial and parallel sections has proven to be most effective. Thus we are able to use Equations 9–12 to generate the beveloid tooth geometry by the axial ( $y_0$ ) and parallel ( $\tilde{y}_0$ ) sections of the worm tool — which is moving translational while tool and workpiece are rotating around their axes with a linked, angular velocity relation (Fig. 6c). The general parametrization of the parallel sections  $\tilde{y}_0$  can be written as:

$$\tilde{y}_0(x_0) = \begin{bmatrix} \tilde{x}_0 \\ \tilde{y}_0 \\ \tilde{z}_0 \end{bmatrix} = \begin{bmatrix} x_0 \\ y_0 + \frac{m_{x0} \cdot z_0}{2} \cdot \Theta \\ z_0 \cdot \cos \Theta \end{bmatrix} \text{ with } \Theta = \arcsin\left(\frac{x_0}{z_0}\right) \quad (17)$$

To realize the modification angle  $\theta$  on industrial gear grinding or cutting machines, the tool is moved addendum by super-positioning the axial and radial feed, in addition to angular velocities of tool and workpiece. In the simulation model the relative position of tool and workpiece is arranged identically to an actual cutting/grinding machine. Taking into account the translational center distances  $a_0$  and the rotation around swivel angle  $\eta$ , addendum modification angle  $\theta$  and displacement angle  $\psi$  (which is needed due to kinematic restrictions of a cylindrical gear cutting/grinding machine [Refs. 15–16]), the tool-workpiece-position for the process kinematic is represented by:

$$Y_0 = a_0 + D_z(\psi)(D_y(\theta)(D_x(-\eta)(\tilde{y}_0))) \quad (18)$$

in which  $\tilde{y}_0$  is the tooth shaping tool section (axial or parallel profile) in tool-based  $\theta$ -coordinate system, respectively, the

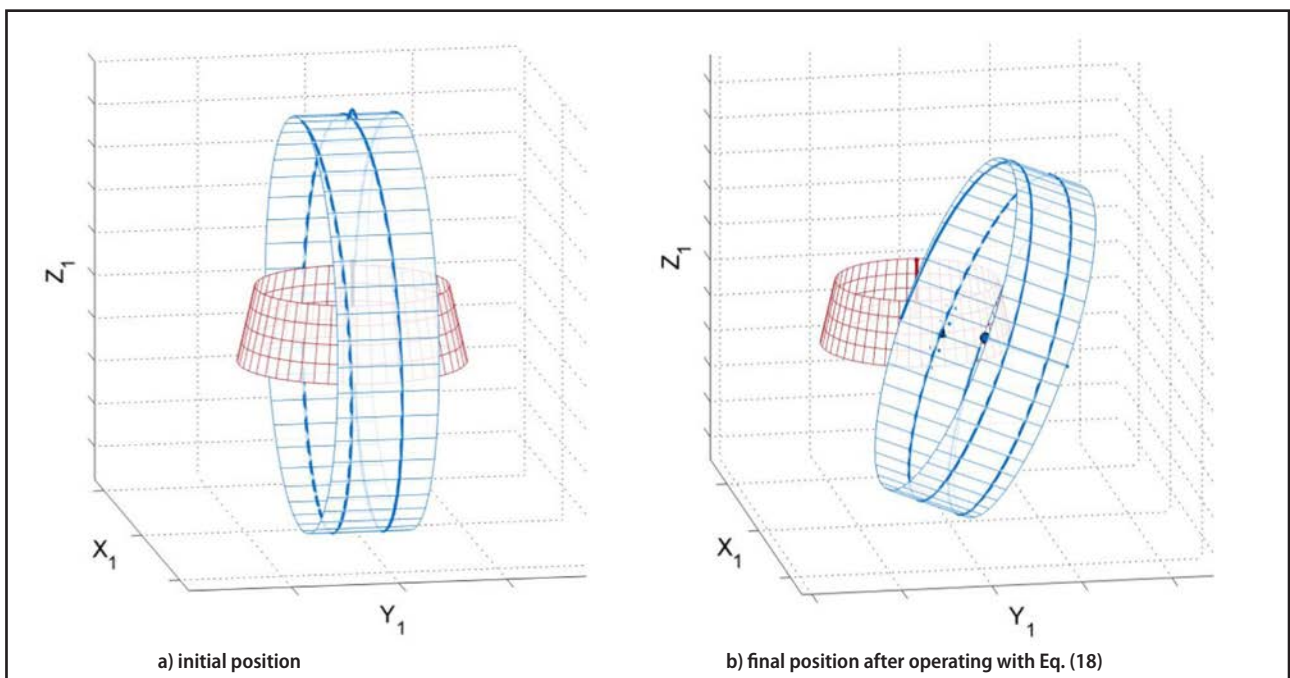

Figure 5 Calculating the relative position of cutting/grinding tool and workpiece.

tooth shaping tool-section  $Y_0$  in workpiece-based global 1-coordinate system (Fig. 5).

With regard to the kinematic configuration of the beveloid grinding process, the operating point between tool and workpiece is shifted due to displacement angle  $\psi$ . Thus we get the adapted manufacturing parameters tool pitch angle  $\dot{\gamma}$ , addendum modification angle  $\theta$  and helix angle  $\beta'$  on the grinding machine (Ref. 16):

$$\sin \gamma' = \sin \gamma_{m0} \cdot \sin \theta \quad \tan \theta' = \frac{\tan \theta}{\cos \psi} \quad \tan \beta' = \frac{(\cos \gamma_{m0} + \sin \gamma_{m0} \cdot \tan \beta_0) \cdot \cos \psi - \cos \gamma'}{\sin \gamma_{m0} \cdot \cos \theta} \quad (19)$$

As a result, we cannot assure that the tooth shaping section is always determined by the tool axial profile  $y_0$ , but also have to take into account directly adjacent parallel sections  $\tilde{y}_0$ .

The synchronized motions of axial and radial tool feed of a real cutting/grinding machine can be converted into a spatial moving path  $f(y_0, \tau)$  of the shaping tool section:

$$f(y_0, \tau) = a_1 + D_{b_1} \left( \frac{2 \cdot \tan \beta_0}{d} \cdot \tau \right) (Y_0) + \tau \cdot b_1 \text{ with } 0 \leq \tau \leq b \quad (20)$$

with tool basic rack helix angle  $\beta_0$ , reference diameter  $d$  and face width  $b$ . Thus, for each face width segment, it is possible to calculate the two-dimensional tooth geometry of the beveloid gear, and eventually the complete three-dimensional tooth.

Furthermore, it is possible to design flank modification not only by modification of the axial tool section profile (Fig. 6a), but also by modification of the spatial tool travel path (Fig. 6b). For example, lead crowning of beveloid gears with the amount  $C_\beta$  can be generated with due consideration of so-called flank twist, which results owing to spatially extended path of contact (Ref. 15). Figure 6d illustrates the described context by an example of

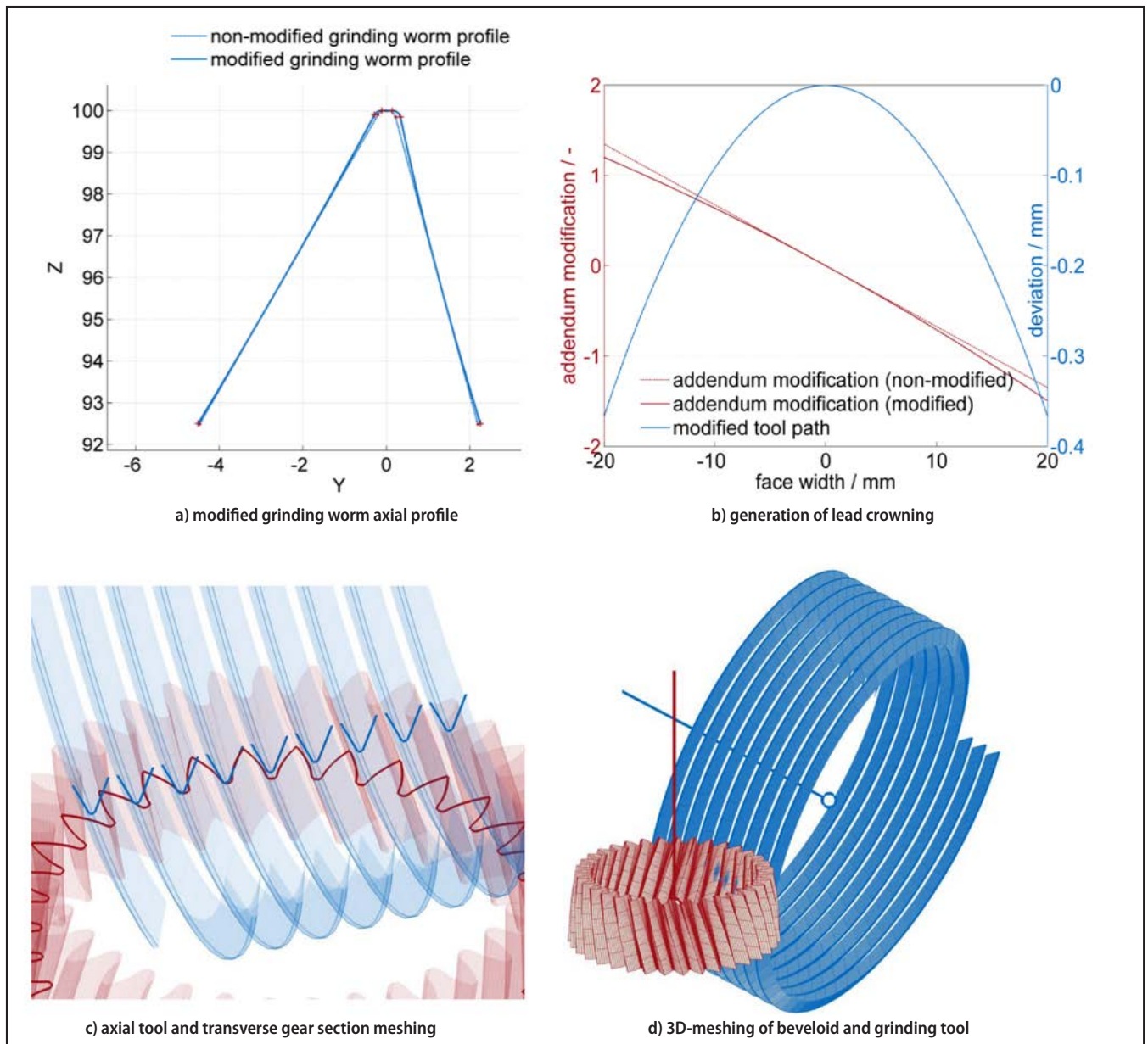

Figure 6 On the generation of modified beveloid tooth geometry by grinding.

a beveloid gear with geometry referred to in Table 1. The grinding tool used for generation has an asymmetric ZN profile.

By setting the addendum modification angle  $\theta = 0^\circ$ , the presented calculation model is readily applicable to the common cylindrical gears. To illustrate the described effects on flank twist, (Fig. 7) clearly shows the calculated difference between a non-modified, theoretical flank (generated by a virtual rack) and a diverging flank (with lead crowning, generated by an involute grinding worm) of a cylindrical helical gear, based on the main geometry in Table 1 with  $\theta = 0^\circ$ . Due to the local variation of the center distance between grinding worm and workpiece to generate lead crowning and, thus, a spatial contact line, the generating worm section removes varying amounts of material along the face width and profile direction of the workpiece, respectively. As a result, we get different amounts of profile angle variation on  $z_1 = 0$  and  $z_1 = b_2$  ( $z_1 =$ workpiece axis), which can be measured as flank twist.

**Practical Application: Rack-and-Pinion Meshing with Variable Ratio**

Steering applications in modern automobiles often require a variable, non-uniform motion transfer between rotational steering wheel and translational steering rack. Changing the lane with high velocity requires a stable maneuvering behavior. On the other hand, with larger steering angles, steering characteristics should become more direct, for example, during a parking situation. To meet these requirements, a variable steering ratio in rack-and-pinion steering systems can be realized by varying the three-dimensional tooth geometry of the rack.

Therefore the theoretical tooth surface of the rack has to be calculated setting the basis for possible manufacturing. Ohmachi et al. (Ref. 23) presented a method to obtain the theoretical profile of the rack with involute pinion based on a numerical solution of Litvin’s (Ref. 13) differential geometry

Table 1 Exemplary geometry of beveloid gear and grinding tool			
	Symbol	Value	Unit
number of threads (grinding worm)	$z_0$	3	-
number of teeth (work piece)	$z_2$	35	-
normal pressure angle	$\alpha_{n0L/R}$	30/15	$^\circ$
normal module	$m_{n0}$	2.5	mm
helix angle (tool basic rack)	$\beta_0$	-18.70	$^\circ$
addendum modification angle	$\theta$	4.8	$^\circ$
profile shift (at working plane)	$x_{2c}$	0.2387	-
face width	$b_2$	35	mm
working plane position	$b_c$	17.5	mm
lead crowning (ref. to working plane)	$C_\beta$	15	$\mu\text{m}$
tip $\varnothing$ , grinding worm	$d_{a0}$	200	mm
reference $\varnothing$ , grinding worm	$d_{m0}$	191.452	mm
root $\varnothing$ , grinding worm	$d_{f0}$	184.972	mm
lead angle, grinding worm	$\gamma_0$	-2.2451	$^\circ$

formula of the basic law of gearing. Wou et al. (Ref. 24) researched the non-uniform gear rack meshing with regard to friction and efficiency. Vaujany et al. (Ref. 25), as well as Alexandru (Ref. 26), derived tooth profiles by kinematics simulation and varying transverse pressure angles.

The described investigations need a set of information concerning pressure angles and working pitch radii or planes, etc. Without any previous knowledge about meshing characteristics, we start with a parametrization of the steering pinion, which is generally given by a helical involute surface  $y(\sigma, \tau)$ :

$$y(\sigma, \tau) = a + D_b \left( \frac{2 \cdot \tan \beta}{d} \cdot \tau \right) \left( \frac{d_b}{2} \cdot \begin{bmatrix} \pm \sin \sigma \mp \sigma \cdot \cos \sigma \\ \cos \sigma + \sigma \cdot \sin \sigma \\ 0 \end{bmatrix} \right) - \tau \cdot b \tag{21}$$

with the surface parameters:

$$\sigma = \sqrt{\left( \frac{d_y}{d_{rf}} \right)^2 - 1} \text{ and } 0 \leq \tau \leq b \tag{22}$$

Alternatively, the pinion tooth shape can be calculated with the mentioned methods for generating cylindrical or conical involute gears.

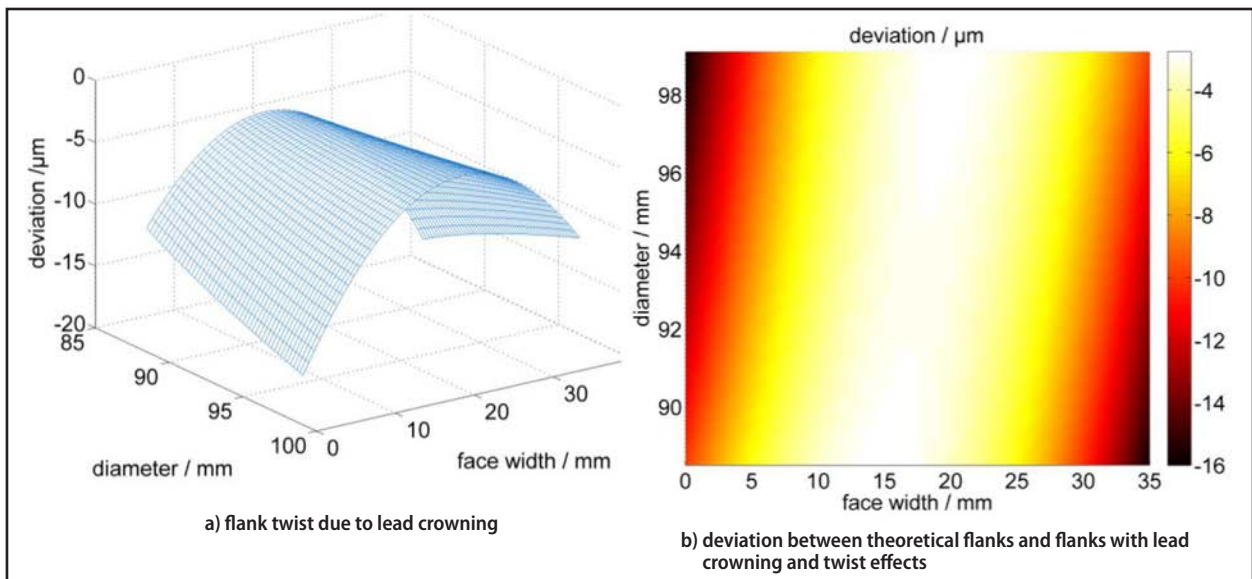

Figure 7 Generation of lead crowning and flank twist of a cylindrical gear.

Furthermore, the variable rack geometry depends on the transmission ratio, which can be given as rack gain to pinion rotation  $v_1(\Delta_2)$ , exemplarily expressed analytically by:

$$v_1(\Delta_2) = 60 - 10 \cdot e^{-0.00005 \cdot \Delta_2^2} \quad (23)$$

see Figure 8 for  $-360^\circ \leq \Delta_2 \leq 360^\circ$ . The transmission ratio can also be defined by any other continuous function or derived practical specifications of the steering gearbox.

With knowledge of the pinion tooth shape and transmission function  $v_1(\Delta_2)$ , the desired three-dimensional rack geometry can be easily computed by applying Equations 13–15 for each local point of contact.

Figure 9a shows the geometry of rack-and-pinion meshing, illustrated in the pinion transverse plane. The axis-crossing angle in this example is  $\Sigma = 82.3^\circ$ . The variation of the rack geometry profile in gain direction corresponds to the given steering ratio in Figure 8. What's more, due to the helical pinion shape the single transverse sections of the pinion are meshing time-delayed with the relevant rack shapes. Thus the geometry of the rack also changes in direction of the pinion face width (Fig. 9b). All relevant, main geometric parameters of pinion and rack are summarized in Table 2.

The identification of limits of the basic law of gearing for ex-

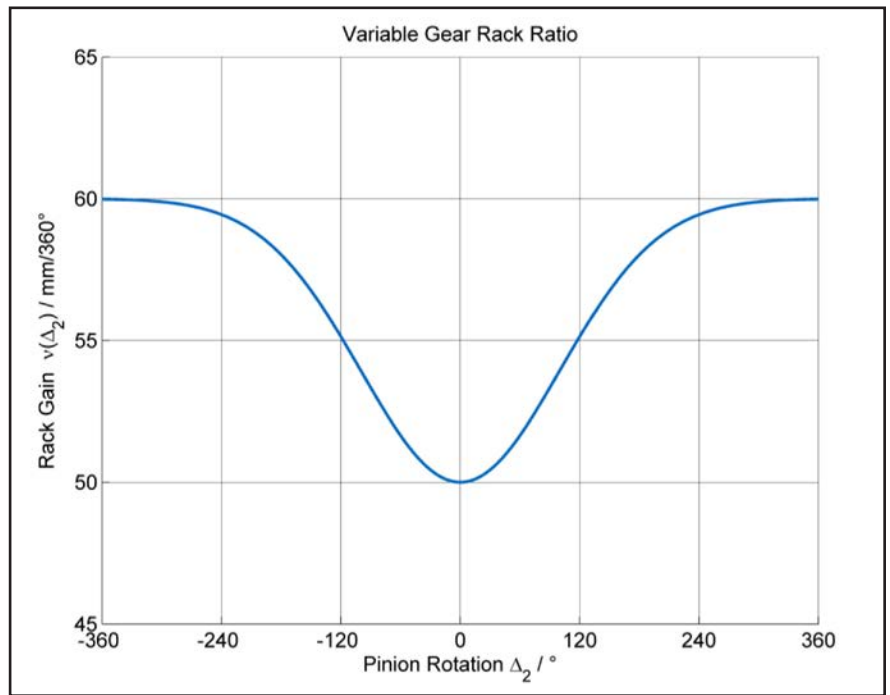

Figure 8 Variable gear rack ratio — as input by Equation 23.

Table 2 Exemplary geometry of pinion and rack with variable ratio			
	Symbol	Value	Unit
number of teeth (rack)	$z_0$	16	-
number of teeth (pinion)	$z_2$	8	-
normal pressure angle	$\alpha_n$	24	-
normal module	$m_n$	1.9	mm
helix angle	$\beta_2$	-25.0	°
profile shift	$x_2$	0.7509	-
pinion face width	$b_2$	36.5	mm
tip $\emptyset$ , pinion	$d_{a2}$	11.0	mm
root $\emptyset$ , pinion	$d_{f2}$	7.62	mm
axis crossing angle	$\Sigma$	82.3	°

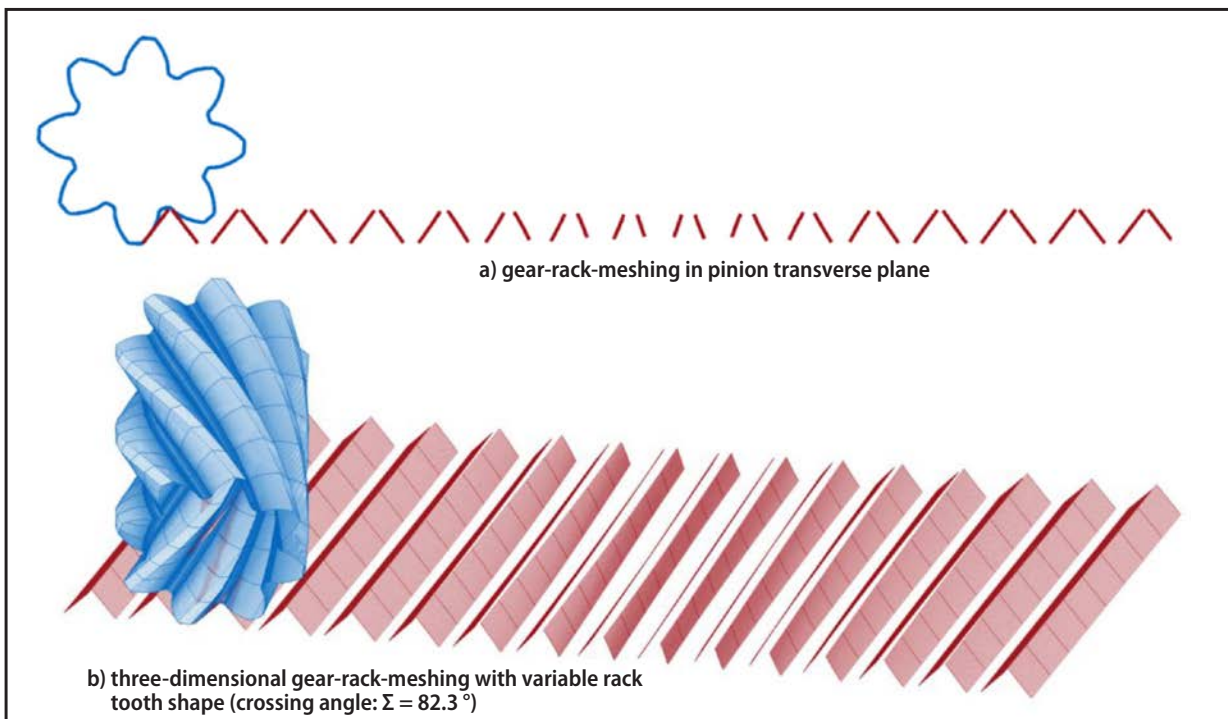

Figure 9 On the generation of the tooth geometry of a rack with variable gear ratio.

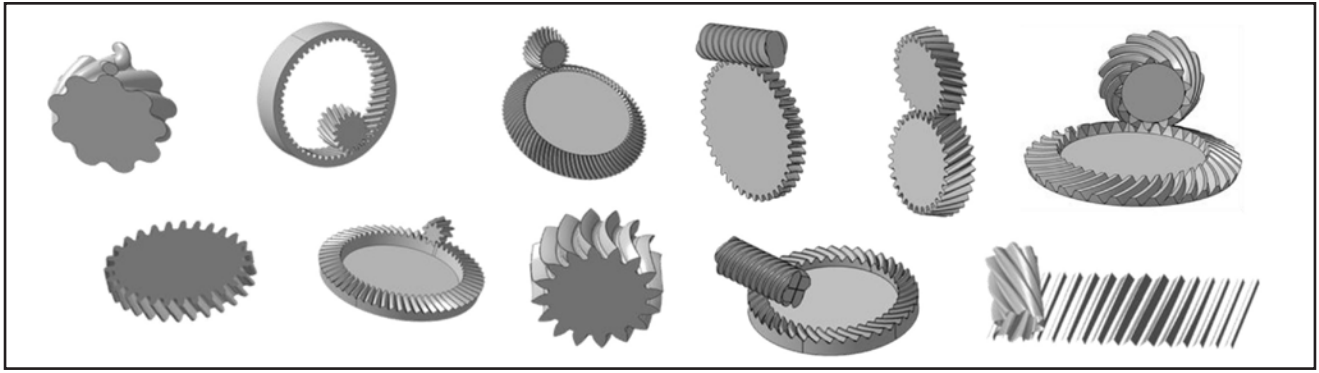

Figure 10 Exemplarily generated gear types — computed via integrated STEP-modeling.

treme transmission ratio, as well as limitation of the computed rack geometry (e.g., tip pointing, intersection with pinion root area, etc.), is subject to further geometric examinations.

### Geometry Calculation Software “Flank Generator”

The described mathematical algorithms are implemented in software modules for the respective gear type then are summarized in the calculation software ‘flank generator’ for industrial usage to support design and optimization process of arbitrary gear types, and especially for non-standard gears and profiles. The following gear types can be computed (selective); (Fig. 10):

- (A)symmetric external and internal cylindrical involute gears
- Bevel and hypoid gears of selected manufacturing methods
- Worm gear drives
- Conical gears (face/crown gears and beveloid gears)
- Spiroid (worm face) gearings
- A multitude of spatial non-involute cylindrical gears (cycloid, W/N-, hybrid gears, EC-gearing, etc.)
- Non-circular gears and rack-and-pinion meshing with variable ratio

For any further processing, an automated export of all computable three-dimensional geometries on the basis of a system-independent STEP-interface according to ISO 10303 (Ref.27) by B-spline computation (Ref.28) was developed (Fig. 10).

### Conclusion

This paper exemplified a mathematical framework to calculate the tooth geometry of arbitrary gear and rack types. Thus, a fast and analytical tool is provided to compute and analyze the geometry of various gear applications, especially non-standard profiles that often cannot be examined by commercial industrial software; this is shown exemplarily in two practice-oriented examples by beveloid gears and variable ratio gear rack meshing.

With regard to state-of-the-art methods of general and particular description of gear shapes, Litvin et al. (Refs. 13–14), Mitome et al. (Refs. 6–7), and Ohmachi et al. (Refs. 23 and 10) derive mathematical models based on differential geometry methods, partially using geometric shapes without modifica-

tions and practice-based manufacturing deviations. These mathematical methods all have in common that the solution of the spatial basic law of gearing is complex to some extent, as the envelope to a family of contact lines has to be calculated by numerical solvers. In contrast, the presented conjugate algorithms for uniform motion transfer in this paper are characterized by full analytical, robust, and thus fast computable solutions.

Furthermore, the presented algorithms form the basis for further investigations concerning development and determination of the manufacturability of novel optimized tooth profiles, depending on the given applications. The described algorithms are summarized in implemented software modules for the particular gear types to support gear design process.

**Acknowledgement.** The project is funded by the Forschungsvereinigung Antriebstechnik e.V. (FVA — [www.fva-net.de](http://www.fva-net.de)).  
**PTE**

### References

1. Scheurle, J. and A. Johann. “On the Generation of Conjugate Flanks for Arbitrary Gear Geometries,” *GAMM-Mitteilung* 23, No. 1, pp.61–79, 2009.
2. Burger, W. and M.J. Burge. “Principles of Digital Image Processing,” 2009.
3. Zimmer, M. and P. Huber. “Erzeugung Allgemeiner Flankengeometrien,” FVA Report 604, FVA Heft 1017, 2012.
4. DIN 867. “Bezugsprofile für Evolventenverzahnungen an Stirnrädern (Zylinderrädern) für den allgemeinen Maschinenbau und den Schwermaschinenbau,” Beuth Verlag, Februar 1986.
5. Stadtfeld, H.J. *Gleason Bevel Gear Technology: Basics of Gear Engineering and Modern Manufacturing Methods for Angular Transmissions*, Gleason Works, 2014.
6. Mitome, K.I. “Design of Nonintersecting-Nonparallel-Axis Conical Involute Gear,” *JSME International Journal Series 3: Vibration, Control Engineering, Engineering for Industry* 34 (2), pp.265–270, 1991.
7. Mitome, K.I., T. Gotou and T. Ueda. “Tooth Surface Measurement of Conical Involute Gears by CNC Gear-Measuring Machine,” *Journal of Mechanical Design, Transactions of the ASME* 120 (2), pp.358–363, 1998.
8. Brauer, J. “Analytical Geometry of Straight Conical Involute Gears,” *Mechanism and Machine Theory* 37 (1), pp.127–141, 2002.
9. Innocenti, C. “Analysis of Meshing Beveloid Gears,” *Mechanism and Machine Theory* 32 (3), pp.363–373, 1997.
10. Ohmachi, T., A. Uchino and H. Komatsubura et al. “Profile Shifted Conical Involute Gear with Deep Tooth Depth,” *Proceedings of the ASME International Design Engineering Technical Conferences & Computers and Information in Engineering Conference, IDETC/CIE*, Las Vegas, USA, ASME 2007.
11. Zhu, C., C. Song and C. Lim et al. “Pitch Cone Design and Influence of

Misalignments on Tooth Contact Behaviors of Crossed Beveloid Gears," *Mechanism and Machine Theory* 59 (1), pp.48–64, 2013.

12. Fuentes, A., I. Gonzalez-Perez and K. Hayasaka. "Computerized Design of Conical Involute Gears with Improved Bearing Contact and Reduced Noise and Vibration," *Proceedings of the International Conference on Gears*, Garching, Germany, ICG 2010.
13. Litvin, F.L. and A. Fuentes. *Gear Geometry and Applied Theory*, Second Edition, Cambridge, 2004.
14. Litvin, F.L. *Theory of Gearing*, NASA reference publication, 1212 AVSCOM Technical Report 88-C-035, 1989.
15. Roethlingshoefer, T. "Auslegungsmethodik zur Optimierung des Einsatzverhaltens von Beveloidverzahnungen," Dissertation, RWTH Aachen, 2012.
16. Zierau, S. "Die geometrische Auslegung konischer Zahnräder und Paarungen mit parallelen Achsen," Dissertation, TU Braunschweig, 1989.
17. Roth, K. *Evolventen-Sonderverzahnungen zur Getriebeverbesserung*, Springer Verlag Berlin Heidelberg, 1998.
18. Tsai, S.J. and S.H. Wu. "Geometrical Design of Conical Gear Drives with Profile-Shifted Transmission," *Proceedings of the 12th IFToMM World Congress*, Besancon, France, June 2007.
19. DIN 3960. "Begriffe und Bestimmungsgrößen für Stirnräder (Zylinderräder) und Stirnradpaare (Zylinderradpaare) mit Evolventenverzahnung," Beuth Verlag, März 1987.
20. DIN 8000. "Bestimmungsgrößen und Fehler an Wälzfräsern für Stirnräder mit Evolventenverzahnungen," Beuth Verlag, Oktober 1962.
21. Predki, W. "Berechnung von Schneckenflankengeometrien verschiedener Schneckentypen," *Antriebstechnik* 24 (2), pp.54–85, 1985.
22. Oetue, M. and M. Denis. "Note Technique CETIM n°22, Cylindrical Worm Gear Geometry," Ed. CETIM, Senlis, France, 1982.
23. Ohmachi, T., H. Komatsubura and K.I. Mitome. "The Tooth Profile and the Line of Contact of the Variable Gear Ratio Rack and Pinion," *Proceedings of the International Conference on Gears*, Garching, Germany, ICG 2010.
24. Wou, S., R. Oste and J. Baxter. "Modeling of Mesh Friction and Mechanical Efficiency of Rack-and-Pinion Steering Design," *SAE 2001 World Congress*, 2001-01-0485, 2001.
25. Vaujany, J.P. and M. Guingand. "Geometry, Kinematics and Load Sharing of Pinion Rack Gear with Variable Ratio," *Proceedings of the JSME International Conference MPT2001-Sendai*, pp.92–97, 2009.
26. Alexandru, P. "The Rack-Pinion Gears for Steering Gearbox with Variable Transmission Ratio," *Proceedings of the 12th IFToMM World Congress*, Besancon, France, June 2007.
27. ISO 10303-500. Industrial Automation Systems and Integration — Product Data Representation and Exchange Part 5001: Guidance on the Usage of ISO 10303-214 for Unit Gears, ISO 2010.
28. Joy, K.I. "Definition of a B-Spline Curve," Visualization and Graphics Research Group, Department of Computer Science, University of California, 1996.

**Maximilian Zimmer** is currently research associate and PhD student at the Gear Research Centre (FZG) at the Technische Universität München (TUM), specializing in gearing calculation and simulation with regard to geometry aspects and manufacturing process. He studied mechanical engineering at the Technische Universität München from 10/2005 to 03/2010. During his studies he worked as a student research assistant at the FZG and wrote his degree treatise on the topic "Calculation and Optimization of Flank Geometry for a Gear Mesh Between Axes of Arbitrary Orientation." After his studies he started his research work at the FZG, focusing in particular on calculation and simulation methods of gears and gearboxes. Zimmer is currently working on his PhD thesis on the topic, "Geometry and Meshing Characteristics of Gearings with Arbitrary Orientation."



**Dr.-Ing. Michael Otto** studied mechanical engineering at the Technische Universität München, while also serving as a research associate at the university's Gear Research Centre (FZG). In 2006 he continued his research at FZG as senior scientist, receiving in 2009 his PhD degree in mechanical engineering. Otto has led the department, "Calculation and Verification Geared Powertrain Systems" at FZG since 2011.



**Prof. Dr.-Ing. K. Stahl** studied mechanical engineering at the Technische Universität München and also served as a research associate at the University's Gear Research Centre (FZG). In 2001 he received his PhD degree (Dr.-Ing.) in mechanical engineering, and that same year started as gear development engineer at the BMW group in Dingolfing, subsequently becoming head of the Prototyping, Gear Technology & Methods group in 2003. In 2006 he moved to the BMW/MINI plant in Oxford, UK, and the next year (2007) became department leader — Validation Driving Dynamics and Powertrain. In 2009 Stahl returned to Munich as manager for Pre-Development and Innovation Management within BMW Driving Dynamics and Powertrain in Munich. In 2011, he became both a full professor at the Institute for Machine Elements and head of the Gear Research Centre. The FZG employs about 80 associates — 50 of them PhD candidates and more than 200 students. Organized in 5 departments, Prof. Stahl's research focuses on experimental and analytical investigations of endurance, tribology, NVH, materials and fatigue life analysis. Components in the focus are cylindrical, bevel, hypoid and worm gears; clutches; synchronizers; rolling-element bearings; and drive systems. Professor Stahl is editor of 6 scientific journals, a member of scientific committees of 7 national and international conferences, holds the VDI ring of honor and is a board member of the board of 2 scientific associations and a member of 4 ISO working groups. He has published more than 100 scientific papers and presentations.



For Related Articles Search

gear design

at [www.powertransmission.com](http://www.powertransmission.com)

# Motor Management — Best Practices

## Part III: Repair Specifications and Preventive / Predictive Maintenance

Reprinted with kind permission of Copper Development Association Inc.

### Introduction

This three-part series on motor management best practices focuses on the importance of instituting a motor management plan as a necessity in effectively administering the electric motors in a facility. The goal of a motor management plan is to take advantage of opportunities for energy savings and increased productivity using energy efficient, reliable motors such as NEMA Premium efficiency motors, herein referred to as “premium efficiency” motors.

Part I of this series addressed conducting a motor assessment for a specific facility, which is a key step in instituting a motor management plan; the steps for conducting a motor inventory; and the motor repair/replace guidelines. Part I also covered how to gain management buy-in through demonstration of the financial gains available through good motor management.

Part II demonstrated the importance of developing a motor failure policy enabling definitive actions that minimize the impact of costly downtime and business interruptions when a motor failure occurs; and the need for a motor purchasing specification as the blueprint for facilitating the process of purchasing new motors. It covered new technologies such as the ultra-efficient copper rotor motor; tools to help identify commonly used motors in your facility and how many to stock; and tools to use to assess which motors are most efficient at yielding the highest energy savings and shortest time to payback. Here are addressed proper motor repair specifications and preventive and predictive maintenance plans.



The goal of a motor management plan is to take advantage of opportunities for energy savings and increased productivity using energy-efficient, reliable motors such as NEMA Premium efficiency motors. With that, predictive maintenance programs (PMPs) are gaining acceptance as a method for maintaining motor reliability. A well-rounded program includes as many technologies as practical — with each technology contributing a significant factor to the diagnostic analysis.



## Motor Repair Specifications

- Four major standards cover the design and manufacture of electric motors; these same sources and standards serve as the sources and references for motor repair specifications and guidelines.
- Electrical Apparatus Service Association: EASA Standard AR 100- 2010 Recommended Practices for the Repair of Rotating Electrical Apparatus
- The European Standard, International Electrotechnical Commission: IEC 60034 Rotating Electrical Machines
- National Electrical Manufacturers Association (USA): NEMA MG 1 Motors and Generators
- Underwriters Laboratories (USA): UL 1004-Standards for Electric Motors

Another useful reference is the *Model Repair Specifications for Low-Voltage Induction Motors*, which is published by United States Department of Energy's Advanced Manufacturing Office (AMO) and was authored by Johnny Douglass, retired Senior Industrial Engineer with the Washington State University Energy Program. It covers the routine repair and the rewind of low-voltage, random wound, three-phase AC, squirrel-cage induction motors. The "Model Repair Specifications" for low-voltage motors contains a detailed set of motor repair procedures. Here is a sampling of its content:

**Documentation:** The repair form is the guide for the repair. The person requesting the repair first fills out the form with information about the problem and the form is subsequently maintained by the repair facilities. This form serves as the paper trail for that motor throughout the repair process.

**Incoming inspection:** This describes the initial tests or root cause analyses necessary to determine the cause of the motor failure. The tests include visual inspection, testing of the winding insulation, evaluating the bearings, and a no-load run test if possible.

**Dismantling:** Part of the failure analysis involved dismantling the motor. Related topics include how to properly mark the motor's end-bells before removal; how to store the parts and identify them with the motor; noting the bearing insulation requirements and associated resistance tests; care required for working with explosion proof motors; and care necessary for rotor removal.

**Vertical motors:** Motor service centers are cautioned to refer to the manufacturer's instructions when repairing vertical motors. Measurements such as rotor lift end-play are critical and they need to be recorded.

**Winding removal:** This section is about collecting data on the winding configuration. It describes the core loss tests that are conducted before and after insulation stripping and iron repair; sets limits on hot spot temperatures and core-loss tolerances; and covers winding burn out procedures as well as temperature and time limits.

That's just a sampling of a few of the specifications that could be examined. Additional line items for model repair specifications are as follows:

- Core preparation
- Rewinds
- Routine overhauls
- Rotor test and repair

- Shaft repair
- Anti-friction bearings
- End brackets
- Balancing
- Reassembly
- Final tests
- Quality control

The *Model Repair Specifications* publication from the Department of Energy (DOE) is available — free of charge — online at [www1.eere.energy.gov/manufacturing/techdeployment/pdfs/repair\\_specs\\_motors.pdf](http://www1.eere.energy.gov/manufacturing/techdeployment/pdfs/repair_specs_motors.pdf).

## Motor Service Centers

**Membership in EASA.** Being an EASA member has its benefits. As an international trade organization with close to 1,900 members in 59 countries, EASA strongly encourages its members to represent the electrical apparatus sales and service industry with the highest quality of business integrity, ability and service by meeting a code of business practice guidelines ([www.easa.com/BusinessPractice](http://www.easa.com/BusinessPractice)).

EASA also provides its membership with access to engineering and educational programs, providing up-to-date information on materials equipment and technology. Members have access to courses or seminars such as *Mechanical Repair Fundamentals of Electric Motors* and the CD series, *How to Wind Three-Phase Stators*. More information on the latter is available at: [www.easa.com/sites/default/files/HowToWindDemos/HowTo\\_sftwr.pdf](http://www.easa.com/sites/default/files/HowToWindDemos/HowTo_sftwr.pdf).

Kitt Butler, director of motors and drives at Advanced Energy, said, "There are many factors to consider when choosing a motor service center. Being a member of EASA is certainly a plus. Its staff in St. Louis helps with all types of technical questions; they support their members through workshops, online webinars, and technical resources. EASA is a great organization. Look for an EASA member when choosing a shop for your motor repairs."

**Service center quality.** The value of a good motor repair specification depends on the quality of the motor service center. Finding good motor service centers requires diligence. Develop a set of criteria before you begin to audit a motor repair facility. Advanced Energy offers some guidelines in its *Horsepower Bulletin*:

- Is the facility's equipment in good condition?
- Is the facility in compliance with safety requirements, neatness and housekeeping?
- Are records and files well organized?
- Are employees knowledgeable and satisfied at work?
- Does the facility keep a variety of wire sizes and shapes in stock? (Look for half and full sizes if you have foreign motors.)
- What is the purpose and frequency of use of the test equipment?
- Does the facility comply with industry standards for motor repair quality and other specifications?
- Check the facility's compliance with standards and procedures published by EASA.
- Does the facility have an active quality assurance program?

(For more information on this topic, visit the Knowledge Center at [www.advancedenergy.org/md/knowledge\\_library](http://www.advancedenergy.org/md/knowledge_library)).

On selecting a motor service center, Butler says, “There are many things to look for in a motor service center’s guidelines. Look for the types of materials and equipment that the shop uses, the calibration procedures for its measuring equipment, the quality of its personnel and the experience and training its personnel. All play a critical role in delivering a good quality repair that maintains efficiency.”

**Evaluate over time.** When choosing a motor service center, it is also important to do your evaluation over time. Don’t base the evaluation just on a single visit and one set of measurements. Provide your repair vendor with the specification and measure them against that specification over time. Some motors service centers create their own guidelines, using a standard such as the EASA Standard AR 100-2010. You can audit a service center against its own guidelines if you haven’t developed your own.

**Original efficiency.** How important is it to restore an electric motor to its original efficiency? Since the cost to repair a motor may be a small percentage of the cost to operate that motor over several years, the motor efficiency when returned to service should be as close as possible to the efficiency it had when new. Many motors operate 40–80 hours per week — or more; so even small increases in efficiency can yield huge energy savings.

The following standards and best practices cover motor repair, motor efficiency and quality assurance programs; they are available as free downloads at [www.EASA.com/energy](http://www.EASA.com/energy).

- “ANSI/EASA AR 100-2010: Recommended Practice for the Repair of Rotating Electrical Apparatus”
- “The Effect of Repair/Rewinding on Motor Efficiency”
- “Guidelines for Maintaining Motor Efficiency during Rebuilding”
- “EASA-Q: 2000 Quality Manual” (purchase item)

**Service center capability.** A motor service center can verify its capability to return a repaired motor to its original efficiency. The decision to repair a motor is often based on the motor’s pre-failure efficiency; a significant decrease in efficiency would increase energy costs and perhaps rule out repair. Proven efficiency verification (PEV) is a quality assurance program offered by Advanced Energy that mutually benefits both motor repair purchasers and providers. The PEV program includes an on-site audit on the use of best practices to bring the service center into conformance. Following the audit, a control set of motors is pre-tested, dam-

“Motor efficiency is important and can be done. We have proven many times that you can maintain efficiency when a motor is repaired. We promote motor repair companies that have demonstrated quality assurance programs that maintain efficiency when a motor is rewound.”

Kitt Butler, director, motors and drives at Advanced Energy Corporation



aged and submitted to the service center for repairs. Service centers meeting the program requirements receive certification.

Butler adds, “Returning a repaired motor to its original efficiency is important and can be done. We have proven many times that you can maintain efficiency when a motor is repaired. We promote motor repair companies that have demonstrated quality assurance programs that maintain efficiency when a motor is rewound.” Details of the PEV program and a list of the currently accredited motor service companies are online at [www.advancedenergy.org/md/consulting/repair\\_shop\\_selection.php](http://www.advancedenergy.org/md/consulting/repair_shop_selection.php).

**Pre-EPAct motors.** No matter the quality of repair, a pre-EPAct motor will never be as efficient as a new, premium efficiency motor. The design of the original motor is the contributing factor. Bruce Benkhart, director, Advanced Proactive Technologies, Springfield, Massachusetts, commented, “When rewinding or repairing a motor, there are a number of things to consider. An older motor that is inefficient might look repairable. However, (even) the best new technologies and the best practices in rewinding can only restore a motor to its original specifications. If it started life as a pre-EPAct, lower efficiency motor, then that’s the best you’re going to get back — no matter the quality of the repair work.”

**Build a relationship.** Build a strong relationship with your motor repair vendors; pressuring your motor service center to rush a repair is never a good practice. A good motor service center adheres to a specific set of guidelines in the motor repair process. Look for a motor service center that adheres to the EASA guidelines. The risks of motor damage and losses of efficiency are too great. A good motor service center will strongly advise against rushing a motor repair. As Douglas explains, “It’s important to understand the viewpoint of your repair facility. There are only a few ways to do it right, but many ways to do it wrong. Demanding they do the job fast is the wrong approach because there are so many ways to cut corners. These shortcuts could get a motor repaired or rewound faster, but most of these methods to accelerate the



process also degrade efficiency and reliability. Good planning and a sufficient quantity of spare premium efficiency motors will allow you to avoid such situations. You can put a new spare in place and have ample time to rebuild the failed motor and return it to spares with minimal downtime.”

## Preventive and Predictive Maintenance

**Differences between PM and PdM.** Preventive and predictive maintenance are distinct activities with the same goal: Maintain the production equipment and plant utility systems equipment in the best possible operating condition for their intended purpose. In general, preventive maintenance occurs during equipment shutdown, and predictive maintenance occurs when the equipment is running in normal operating mode. The former keeps equipment working, and the latter identifies and corrects potential problems during a non-disruptive time. Says Douglass, “Preventive maintenance is more familiar to most people; it’s been done since as long as there have been motors. Predictive maintenance is analogous to what happens in a modern doctor’s office. The doctor does not just reactively treat serious conditions but rather tests for hidden indicators such as blood pressure and cholesterol and corrects them before something serious happens such as a heart attack or stroke. Modern electrical instrumentation allows you to see a lot more about what is happening and developing inside a motor than you could in the past. Using these instruments you can anticipate a failure condition before it happens and intervene with corrective actions.”

**Skills and responsibilities.** Who does the work? Someone with a high level of maintenance, plant or facilities engineering experience writes the documentation that describes each task. Such a person would understand many aspects of electric motor systems: i.e., aging characteristics; impact of contaminants; temperature extremes; moisture; corrosives contact; vibration; lubrication; and use of instrumentation.

The tasks require skilled mechanics and electricians; the majority of work requests are for inspection and only a small percentage are for lubrication — despite the importance of the latter. Those performing the tasks must have a detailed understanding of the equipment so that they can effectively inspect and correctly evaluate problems.

Those directly responsible for managing the mechanics and electricians must also understand preventive and predictive maintenance. The manager should have sufficient skills to participate in the system’s failure analysis and direct the actions to prevent future failures. Upper management must support the preventive and predictive maintenance programs as necessary and important functions in the production process. They will be called on to authorize planned downtime of equipment and to implement the maintenance programs.

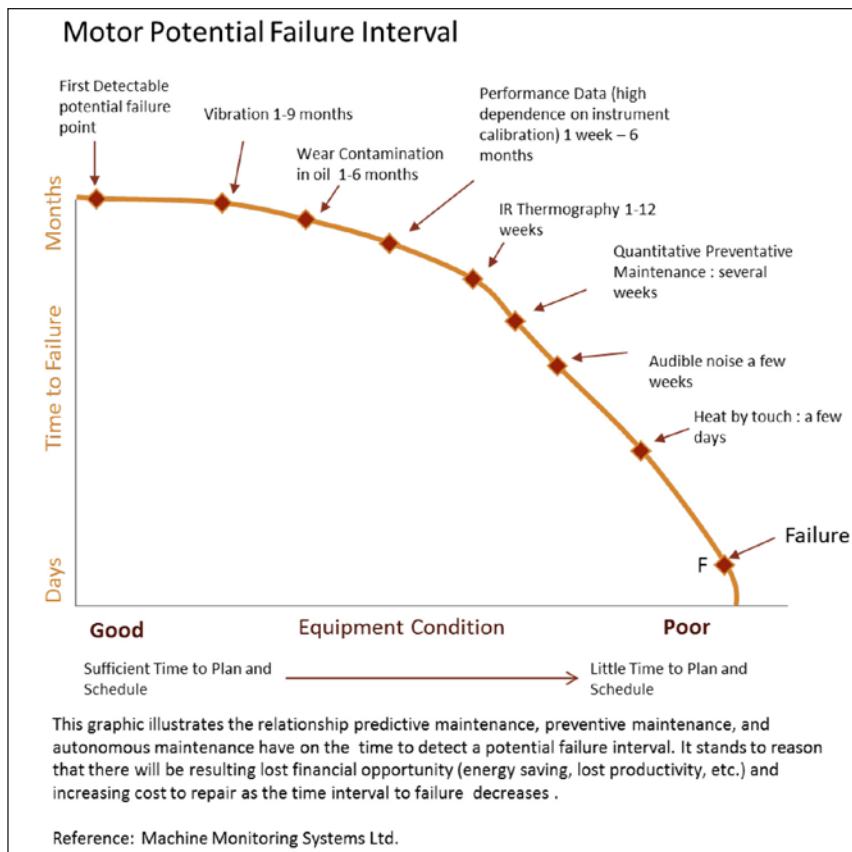

In addition to the technically skilled maintenance personnel, production employees can participate in a preventive maintenance program. Those closest to the working systems are the most likely to notice changes in equipment operation; they could be trained to perform inspection and lubrication tasks.

Equipment suppliers can contribute to any preventive and predictive maintenance program. They tend to be more knowledgeable about their equipment and often have advanced skills, especially true in the use of predictive maintenance instrumentation. As a major motor distributor with five locations across New York State, KJ Electric provides its customers with many services, including laser alignment, full-spectrum vibration analysis, thermography analysis, dynamic balancing and shaft voltage testing. For more information, see [www.kjelectric.com](http://www.kjelectric.com).

Kenneth E. Jacobs, CEO, KJ Electric points out, “We offer our customers thermography imaging for their motors and motor systems. This service can identify hotspots in the motors and power systems as a predictor of early failures. The results of the thermography analysis point to preventive maintenance actions that could circumvent a failure.”

## Preventive Maintenance

Preventive maintenance (PM) is maintenance performed on electrical motor systems at scheduled intervals. PM is necessary to optimize motor life. The timing of the intervals depends on the known reliability or failure rates of the motor components in the operating environment. Dirty or corrosive environments mandate frequent PM actions. Most in-

dustrial facilities have some form of preventive maintenance program.

Rick Scott is assistant director of facilities operation at St. Lawrence University in Canton, New York. This private university comprises 70 buildings and enrolls about 2,300 students. The school owns hundreds of motors with horsepower between 1 and 50. Many of them drive pumps and air handlers, and many have variable speed drives. “At our facility we’ve done quite a bit to save energy. We have a preventive maintenance program with one person dedicated to that task. The program entails regular servicing of our air handlers, pumps and drives, as well as replacing belts and filters. Normally we will replace a motor larger than one horsepower with a premium efficiency motor whenever it fails, so long as it is not a candidate for repair. Sometimes we replace older motors that are still running with premium efficiency motors. For example, whenever a pump fails we just replace the whole system. Premium efficiency motors tend to have higher reliability. We try to increase efficiency and save on electrical costs.”

### Bearing Considerations

**Lubrication.** Proper bearing lubrication is one of the tenets of a preventive maintenance program. Bearing failures account for a significant portion of the mechanically related problems. (See sidebar, “Most Frequent Motor Failure Areas.”)

If you only detect bad bearings by noise or vibration, then you will always be too late. At that point mechanical damage to the bearing raceways and perhaps even the motor shaft have already happened. And, you have already incurred extra energy costs by operating the motor with increased frictional load to the motor. Butler fully acknowledges the importance of lubrication in a preventive maintenance program. “Preventive maintenance is important for electric motors,” he says, “and lubrication is probably the most important aspect of PM. Make sure you have the proper type of grease and apply the proper amount in a motor on its regularly scheduled intervals.”

Bearings do not necessarily wear out—but they do fail—and lubrication issues are a major factor in bearing failure. According to a white paper on bearing failure published by Applied Industrial Technologies, improper lubrication accounts for 40 to 50 percent of bearing failures; improper bearing installation for 25 to 30 percent; and other causes account for 20 percent of bearing failures. Achieving the natural fatigue limits of the bearing accounts for less than one percent of bearing failures! With proper preventive maintenance, bearings should outlast the useful life of the motor. (Read the white paper at [http://web.applied.com/base.cfm?page\\_id=3702](http://web.applied.com/base.cfm?page_id=3702).)

Lubrication in anti-friction bearings prevents metal-to-metal contact between the rolling elements, raceways and retainers. The lubricant also provides protection against corrosion and wear, dissipates heat, and acts as a barrier to keep out solids and liquid contaminants. The anti-frictional properties of the lubricants allow the motor to run much more quietly. Yet, bearing lubricants break down over time and therefore need periodic replenishment. Use the lubricants

approved by the manufacturers and follow the manufacturer’s specifications for the correct application of the lubricant.

**Motor shaft grounding.** Variable frequency drives (VFDs) can cause bearing failures by inducing currents in motor shafts. This problem is specific to VFDs and affects both AC and DC motors. Considering how they can save energy and lower operating costs, VFDs are increasingly used for process control, pumps, air handling, conveyers, spindles and many more applications. As the drive switches on and off speed variations cause voltage buildups that seek a ground potential. Oftentimes the most direct path is through the bearings. The bearing lubricant can act as an insulator but the lubricant’s resistive properties will eventually break down, and the resulting electrical current flow pits the metal surfaces and the bearings eventually fail.

Fortunately, solutions to this problem do exist. According to Gilbert A. McCoy, P.E., Energy Systems Engineer, Washington State University Energy Program, “Currents induced in a motor shaft and grounded across the bearings cause fluting, which is a type of bearing damage. To eliminate fluting consider installing a shaft grounding brush and/or insulated bearings so that the currents do not form and flow across the bearings raceway.” Other solution options include hybrid ceramic bearings and line reactors or filters. However, fluting may occur regardless of the efficiency class of the motor — premium efficiency, energy efficient, or standard.

### Predictive Maintenance

Predictive maintenance programs (PMPs) are gaining acceptance as a method for maintaining motor reliability. A well-rounded program includes as many technologies as practical — each technology contributing a significant factor to the diagnostic analysis. The scheduled static test and the more aggressive dynamic test are both useful in the prediction of potential motor systems failure.

**Advantages, disadvantages.** PMPs can be expensive — but they provide real benefits. The main advantage is expressed as follows on the website of the Department of Energy. According to the DOE, “A well-executed program can almost eliminate catastrophic equipment failure because issues are identified and eliminated prior to any significant system deterioration.”

**Such programs save time and energy in other ways, too. The following average savings are typical within industrial settings:**

- Return on investment of up to 10X
- Maintenance costs reduced by 25–30 percent
- Elimination of breakdowns by 70–75 percent
- Downtime reduction of 35–45 percent
- Production up by 20–25 percent
- Advantages include the following:
  - Allows preemptive corrections
  - Increased system reliability and lifespan
  - Decreased equipment or process downtime
  - Decreased costs for parts and labor
  - Better product quality
  - Improved safety
  - Energy savings

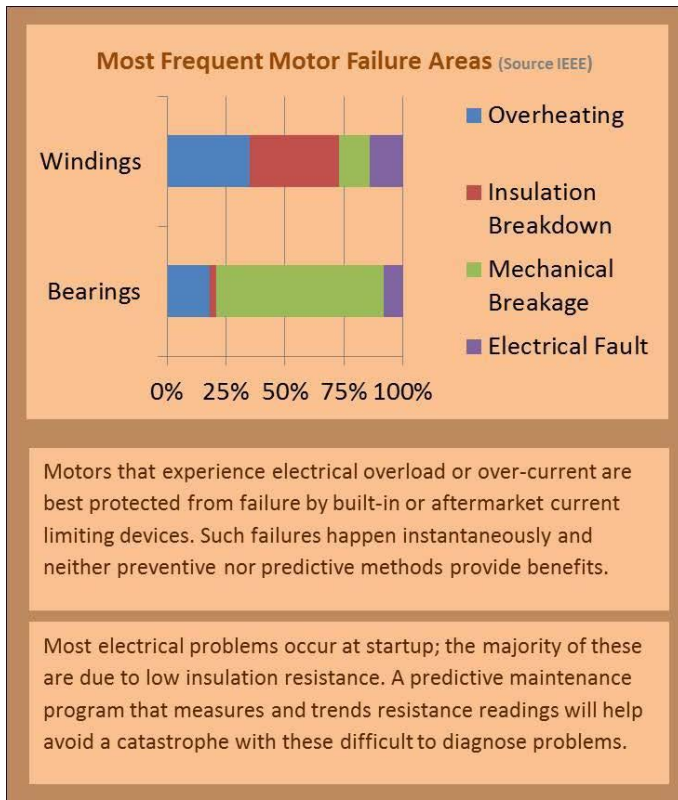

- Estimated 8–12 percent cost savings over preventive maintenance

Disadvantages include the following:

- Increased investment in diagnostic equipment
- Increased investment in staff training
- Savings potential not readily seen by management

For details, see: [www1.eere.energy.gov/femp/program/om\\_predictive.html](http://www1.eere.energy.gov/femp/program/om_predictive.html).

### Performance Trending

When conducted periodically, predictive maintenance lends itself to performance trending. Equipment issues needing maintenance show up as abnormal performance trends. Once you establish your motor management plan and complete your motor inventory, then the findings of predictive maintenance can be added to the motor inventory database. Benkhart says, “Many facility managers want to inventory every motor, not only for an energy assessment but also for the backbone of a maintenance program. Predictive maintenance measurement results are entered into *MotorMaster* + and become part of the record. Anyone knowledgeable of the metrics can follow the trends of the equipment.”

You cannot predict when equipment will fail; you can only assess the potential for failure. McCoy says, “Predictive maintenance involves taking periodic measurements, trending those measurements, and knowing when a motor is starting to show signs of deterioration. This data and knowledge enables the maintenance staff to intervene before the motor fails. Some plants prefer the term ‘condition assessment’ rather than the term ‘predictive’ because management may assume they can predict when something is going to fail.”

Douglass was asked, “If you cannot predict when a failure will occur, what should you do?” He responded, “When a motor analyzer is used in a predictive maintenance program, typically the results are used to assign a condition status to a motor like red-green-yellow: green means the motor is okay, yellow means there are signs of deterioration, and red perhaps means replacing that motor at the nearest possible opportunity. As a motor shows signs of deterioration, you might put it on a watch list, take measurements more frequently and be prepared to intervene before the motor actually fails. These watch lists are useful because they inform management about the health of the motor population in the plant. Remember, the goal of predictive maintenance is to increase uptime, decrease failures, improve reliability, and ultimately increase plant productivity.”

**Predictive maintenance technologies.** There are several predictive maintenance technologies:

- Thermography or infrared imaging can generate a visual image, which shows variations in the infrared radiance on the equipment surfaces. It is useful in identifying hotspots because of poor electrical connections or poor air circulation.
- Lubricant and wear-particle analysis is also known as oil analysis. The lubricant condition is useful in determining if maintenance is required.
- Ultrasound analysis is similar to thermography, but uses sound waves to image internal systems, enabling the detection of system wear, leaks or failures.
- Vibration analysis seeks to identify system degeneration exceeding permissible levels. Abnormal levels indicate excessive system wear or equipment misalignment.
- Motor analysis includes several test measures that are used to identify such issues as winding short-circuits, open coils, incorrect torque limits and mechanical problems inside a motor.

One such motor analysis tool is the power quality analyzer (PGA). It provides extensive capabilities for recording and trending power quality events. Several power quality analyzers are available and they vary in price and features.

Regarding PQAs, Anthony J. Simon, energy engineer at Washington State University, says, “The power quality analyzer (PQA) provides the highest level of sophistication in data collection for determining motor load inefficiencies. The inputs are voltage and current. The voltages for all phases are live measurements from the operating motor. The current is a nonintrusive measurement using a current transducer, or CT, with clips that wrap around the conductors. From these measurements the PQA records the motor load at different times during the operating process. The power quality analyzer not only measures true kilowatt power — it measures harmonics; and it can give useful information on voltage unbalance and other aspects of motor operation.”

### Spending Decisions

The potential for a system failure tends to be inversely proportional to predictive maintenance put into a system; however, predictive maintenance can be expensive, so a well-planned application is recommended. A good understanding of your motor inventory and a proper identification of the systems

SKF Dynamic Motor Analyzers-EXP4000



ALL-TEST PRO® On-Line II



CR Magnetics  
Split Core Current Transducer CR41



most critical to your plant or facility allows you to decide where to best spend your predictive maintenance dollars.

As Butler explains, “Old timers just walked through the facility using their eyes and ears as the only predictive maintenance program available. They had strong intuitions about what was going to happen to a motor long before it failed. For example, they could often ‘sense,’ without explaining how, whether it was a bearing or a misalignment issue. Thankfully there is lot more science out there today in terms of current signature analysis, and there are a lot more tools available to really analyze motors. PdMA, Baker and All-Test Pro make or distribute signature current analysis tools that dramatically assist with predictive maintenance today.”

**Summary: Motor Repair and Maintenance**

A motor repair specification, along with preventative and predictive maintenance, aims at ensuring quality repairs, long motor life, minimal downtime and energy savings.

The best assurance of repairing a motor to its maximum energy efficiency is a well thought out and documented repair specification built on use of technical resources and membership in trade organizations, as well as a well-developed relationship with an accredited electric motor service center.

Establishing and adhering to an electric motor preventative maintenance program, augmented by periodic predictive maintenance, is the best insurance for the longevity and efficiency of a facility’s motor systems. (NOTE: If your facility does not have the staff, or requires either training or direct services for preventative and predictive maintenance, contact your local electric motor service center for assistance. Also, the U.S. Department Energy has implemented a new website—Energy Information Administration (eia)—at <http://energy.gov>; and the Advanced Manufacturing Office at <http://www1.eere.energy.gov/manufacturing>. (NOTE: At this writing the current links to DOE articles in this publication continued to be applicable.) **PTE**

**For more information:**

- [www.pdma.com/index.php](http://www.pdma.com/index.php)
- [www.skf.com/portal/skf\\_bak/home/products?contentId=774348&lang=en](http://www.skf.com/portal/skf_bak/home/products?contentId=774348&lang=en)
- [www.alltestpro.com](http://www.alltestpro.com)
- [www.crmagnetics.com](http://www.crmagnetics.com)

For Related Articles Search

maintenance

at [www.powertransmission.com](http://www.powertransmission.com)

**Acknowledgements.** CDA acknowledges the assistance of government and industry-based motor experts in the creation of the Motor Management Best Practices series. The following individuals were cited in at least one of the three published installments:

**Emmanuel Agamloh**, Ph.D., P.E. motor systems engineer, Advanced Energy Corporation, Raleigh, North Carolina (919) 857-9023, [eagamloh@advancedenergy.org](mailto:eagamloh@advancedenergy.org).

**Bruce Benkhart**, director, Advanced Proactive Technologies, Springfield, Massachusetts. Benkhart is available at (413) 731-6546 [bruce@appliedproactive.com](mailto:bruce@appliedproactive.com).

**Tom Bishop**, P.E., senior technical support specialist, Electrical Apparatus Service Association (EASA), St. Louis Missouri. [www.easa.com](http://www.easa.com).

**Kitt Butler**, director, motors and drives at Advanced Energy Corporation (AEC), Raleigh, North Carolina (919) 857-9017. [kbutler@advancedenergy.org](mailto:kbutler@advancedenergy.org).

**Johnny Douglass**, retired senior industrial engineer, Washington State University (WSU) Extension Energy Program (360) 956-2086 [douglass.johnny@gmail.com](mailto:douglass.johnny@gmail.com).

**Gilbert A. (Gil) McCoy**, P.E. energy systems engineer with the Washington State University (WSU) Energy Office, Olympia, WA. (360) 956-2086, [mccoyp@energy.wsu.edu](mailto:mccoyp@energy.wsu.edu).

**Rob Penney**, P.E., certified energy manager, senior energy engineer at Washington State University (WSU). Penney is available at (360) 628-2053, [penneyr@energy.wsu.edu](mailto:penneyr@energy.wsu.edu).

**Anthony J. Simon**, energy engineer, Washington State University (WSU). (360) 956-2141, [SimonT@energy.wsu.edu](mailto:SimonT@energy.wsu.edu).



Emmanuel Agamloh



Bruce Benkhart



Tom Bishop



Kitt Butler



Johnny Douglass



Gilbert A. (Gil) McCoy



Rob Penney

## Power Transmission Engineering online!

It's like your own professional superpower.

Stronger, faster and smarter than your average website, [www.powertransmission.com](http://www.powertransmission.com) offers everything you need to supercharge your engineering-oriented organization.

- Complete archive of articles on engineered components
- Directory of suppliers of gears, bearings, motors and other mechanical power transmission components
- Product and Industry News updated daily
- Exclusive online content in our e-mail newsletters
- The Bearings Blog
- Calendar of upcoming events
- Comprehensive search feature helps you find what you're looking for — *faster than a speeding bullet!*

[www.powertransmission.com](http://www.powertransmission.com)



# Global Industrial Outlook: Batten Down the Hatches

Brian Langenberg

**Third-quarter earnings confirmed the worst-case scenario**—plunging oil prices are whacking almost the entire industrial sector. The theme is hardly new, as the pattern of our headlines has revealed over the past fifteen or so months:

Nov. 2014	Houston, We Have A Problem
Feb. 2015	Oil Slick, Currency Headwinds Challenge Growth
Mar. 2015	Oil Slick, Currency Headwinds Worsen
May. 2015	Slow Growth Ahead, Farm Belt Can't Help
Jul. 2015	Sluggish
Sep. 2015	Game Changer
Oct. 2015	Weathering The Storm
Nov. 2015	Oil Slick Cascading
Jan. 2016	Batten Down The Hatches

So what is in store for us over the next year or so? With oil prices continuing to plunge the pain will only worsen, and some see half of North American shale producers going bankrupt.

**The Macro Economy.** It sucks; Conoco and Marathon are calling out up to (60%) capital spending cuts for 2016, while other companies are talking (10–15%) cuts in their annual plans. Guess how that is going to go. Biggest electrical equipment company exposures are Emerson, Dover Corporation and

General Electric, but the effect continues to be the worst for construction machinery companies.

**Regional View.** To the extent your company is exporting, here is how things stack up now—and at least through 2016:

**North America.** U.S. continues to slog forward despite headwinds (Oil, FX, the Obama Administration, Congress). Housing and construction should benefit from lower commodity prices on a net basis, excepting the Gulf Coast and the Dakotas.

**Europe.** Western Europe faces a major headwind (China weakness), partially offset by a weak Euro that benefits exports to the U.S. Russia is acting tough militarily, but is living on borrowed time given low commodity prices as most of their economy is oil, gas, and minerals.

**Asia.** China remains weak. Australia is indeed down under. India continues to strengthen, but this is material only for Cummins; and even then, much of their India-centric production is located in or closer to India; i.e.—does not help you.

**Middle East.** War is good for defense spending—bad for everything else.

**Latin America.** Brazil is in deep trouble. On the other hand, a lot of arrogant leftists aren't looking so smart,

now that their petro and commodity dollars are going away. Mexico is the (bright) exception—not only are they recapitalizing their oil sector (Pemex) with outside capital and technology, but the country continues to encourage, and see, investment in manufacturing including automotive, aerospace and consumer goods. We see this continuing given the close economic and cultural relationship between the U.S. and Mexico, common interests (keeping “El Chapo” in jail, Sean Penn notwithstanding), and not having all our mutual eggs in the China basket.

## Risks, Variables, and Black Swans

The question is, What can go right from here, and what can go wrong. The “what can go right part” includes the positive benefit of low commodity prices. The possible downsides:

1. Oil price-driven recession? We don't see it.
2. Fed policy error—raising rates too much, too soon? It's Janet Yellen; let's be serious.
3. Black Swan—Russia and the U.S. are shooting live rounds in the same freakin' geographic area. Mistakes happen.





## Market Outlook

Given the rough January market start we are going to write from an investment perspective instead of our usual focus company. Why? Because it affects your 401K!

Despite the fact that about nobody can really time the market, consistently, over time, we have a market view anyway.

**This is an election year.** That means big decisions are postponed until 1H 2017. We do pencil in a not so scientifically derived 0.002% chance that President Obama and Congress do something productive this year. We call this optimism.

**Muddling through is likely.** The bad news is that China is weak and energy prices have plummeted. The good news is that much of the impact has already been felt or is at least explicitly or implicitly factored into the production schedules of your customers and, to a significant extent, the market.

**U.S. recession is unlikely—but possible.** In 2013 three of the top four U.S. corporations in terms of revenue were ExxonMobil, Chevron, and ConocoPhillips with about \$950 billion in revenue, which equates to about 5% of U.S. GDP. Oil was at \$100 or so. Now it is below \$40. While consumers and logistics companies benefit, the Gulf of Mexico (important) and the Dakotas (not so much unless you live in the Dakotas) will see their regional economies hit.

However, markets climb a wall of worry and we see 2150 on the S&P 500 as reasonable at year-end.

What should you do about this? Nothing different—unless you are a committed investor, make sure you

P/E	S&P 500 Earnings			Implied Price Return		
	<10%	<5%	Street	\$113	\$119	\$126
16x	1,812	1,908	2,008	(11%)	(7%)	(2%)
17x	1,926	2,027	2,134	(6%)	(1%)	4%
18x	2,039	2,146	2,259	(0%)	5%	11%
19x	2,152	2,265	2,385	5%	11%	17%
20x	2,265	2,385	2,510	11%	17%	23%

Market Return	% Prob.	
↑ ↑	0.001%	Election year repeal of Obamacare, Dodd-Frank, tax reform.
↑ ↑	0.001%	ANYTHING from above.
→ →	95%	\$40 oil, US low growth, Middle East slows, China stinks.
↓ ↓	4.999%	US recession (low oil, policy error)
↓ ↓	0.999%	Black Swan: Shooting war w/Russia.

have your savings plan in place, appropriate asset allocation in your investment and retirement accounts and, as well, make sure you have thoroughly reviewed the performance, costs, and tax efficiency of any investment vehicles in your retirement plan.

**Further Your Career.** The Dunham Graduate School of Business MBA with a Leadership concentration is ideally suited for technical or engineering professionals seeking to gain the business skills, tools, and mentorship to further their careers. AU also offers adult degree completion programs.

Highly accomplished professional business people teach our courses, whether on ground or online (same professors).

- Front-end career goal discussion and mentorship. We want you to succeed.
- Rolling admission with six 8-week terms per year allows you to flex up/down depending upon your needs.
- Focused curriculum: 12 classes – 7 core, 5 electives. Each core class is a basic building block you need; the electives are geared for your objectives.
- Locations: Aurora, Illinois, Woodstock, IL and Online.

Contact [blangenberg@aurora.edu](mailto:blangenberg@aurora.edu) to arrange for a phone or in person discussion.

**Strategic consulting:** Langenberg & Company provides a range of consulting services—strategy, financial benchmarking, M&A pipeline development—for private or public companies and executives. Contact [Brian@Langenberg-llc.com](mailto:Brian@Langenberg-llc.com) to discuss.

**Wealth management:** Langenberg & Company has established an alliance with Chicago Partners Wealth Advisors. Contact us for a complimentary portfolio X-ray (minimum recommended account size \$500,000). **PTE**

**Corporate Services:** Langenberg & Company provides a range of consulting services—strategy, financial benchmarking, M&A pipeline development—for private or public companies and executives. Contact [Brian@Langenberg-llc.com](mailto:Brian@Langenberg-llc.com) to discuss.

### Brian K. Langenberg, CFA

has earned recognition as a member of the Institutional Investor All-America Research Team, a Wall Street Journal All-Star, and Starline Best on the Street. As Principal of Langenberg & Company, he advises CEOs and senior executives on strategy and capital markets, and makes numerous public speaking appearances. In July 2015 he was named Chair (and Lecturer) of Graduate Business Programs at Aurora University.



## Bosch Rexroth

ANNOUNCES EXECUTIVE BOARD CHANGES

**Rolf Najork**, 53, took the position of chairman of the executive board and the responsibility for development at Bosch Rexroth effective February 1st. Najork was managing director of Heraeus Holding GmbH responsible for production, purchasing, and development. He held various technical management positions at Ford and Getrag after completing his mechanical engineering studies at RWTH Aachen. As an executive management member in automotive he was responsible for the E-mobility, Mechatronics, and R&D transmission divisions within the Schaeffler group.



**Dr. Karl Tragl**, 53, left Bosch Rexroth after the expiration of his contract on January 31, 2016. He has been an executive board member since 2008. Tragl joined the company in 2000 and was responsible for the global service in the market segment Factory Automation. In 2003, Tragl joined executive management and became the chairman of the business unit Electric Drives and Controls of Bosch Rexroth AG in 2004.



“We thank Mr. Tragl for his high level of commitment in various positions at Bosch Rexroth. He greatly contributed to the establishment of Industry 4.0 in the business, to the preparation of emerging markets like Africa, and to the successful implementation of major projects. Over the past years, Tragl furthermore aligned the company toward its core business and introduced the necessary measures. We wish him all the best for his future endeavors,” says chairman of the supervisory board Dr. Werner Struth. “With Mr. Najork, we are simultaneously gaining a highly qualified executive with proven expertise for our industrial division.”

## Rexnord

HIRES SCHNEIDER AS VICE PRESIDENT,  
POWER TRANSMISSION

Rexnord is pleased to announce the hiring of **Bradd Schneider** as vice president of the Americas Region for Power Transmission (PT). Schneider brings more than 20 years of experience in industrial sales leadership. Prior to joining Rexnord, he held the position of vice president,



global sales at Honeywell International, Air Transport and Regional Aerospace Division. “Bradd’s extensive experience in driving a performance culture through leveraging a disciplined sales process provides a strong foundation for his continued success at Rexnord,” says Kevin Zaba, president, Rexnord PT. In his new role, Schneider is responsible for driving sales growth, continuously improving sales excellence, and maximizing customer satisfaction for the PT business in the Americas region. He received his bachelor of arts degree from Indiana University.

## SKF

OFFERS KNOWLEDGE-SHARING SYMPOSIUM

SKF sparks conversation and spreads ideas with a new series of a knowledge-sharing symposium called “Let’s Talk”. Industry experts are discussing topical trends such as Digitalization, Industry 4.0 and Sustainability in front of a live audience. The events are being held at Chalmers University of Technology, Gothenburg, Sweden and will be published on YouTube.

The first event’s topic is all about Big Data and Industrial Digitalization. Speakers are Johan Stahre, head of division production systems, Chalmers University of Technology; Kent Eriksson, business consultant Internet of Things, PTC and Victoria Van Camp, director technology and solutions, SKF Group.



“SKF has been dealing with Smart Data for the last 30 years. In the beginning we worked with hand-held devices to take in data from our customers to prolong their machines’ service intervals. Data as part of an entire puzzle is more valuable than data in small pieces. Today, Big Data can be analyzed and I see a great opportunity in that. The combination of analytics and diagnostics with knowledgeable people is going to be very powerful in the future,” says Victoria Van Camp, director technology and solutions, SKF Group.

The recorded symposium will be published on SKF’s YouTube channel. Further information can also be found on the website below or by following the hashtag #LetsTalkBigData across Twitter, Facebook, LinkedIn and Instagram. More “Let’s Talk” videos will be published in the upcoming months.

# NKE & Fersa Bearings

FORM STRATEGIC ALLIANCE

Fersa Bearings based in Zaragoza, Spain has acquired a 49 percent stake in Austrian bearings manufacturer NKE Austria GmbH. Both manufacturers combine their strengths and competences to become even stronger strategic suppliers of bearings for global OEMs and distributors in their market segments, with

NKE as a premium alternative for the industrial market sector, and Fersa in the automotive market sector. Both bearing companies complement each other and combine know-how in



manufacturing and distribution of bearings for many years. Through this new partnership, the Spanish multinational company together with the Austrian bearing manufacturer will now have three state-of-the-art production facilities, five distribution centers as well as three R&D centers.

Both brands operate independently. The goal of this European cooperation is to offer customers more possibilities and solutions, and the generation of synergies to ensure common business development and growth.

# Comau & B&R Industrial Automation

COLLABORATE ON ROBOTIC SOLUTION

The partnership between Comau Robotics and B&R Industrial Automation is opening up a new opportunities for robotic integration for machinery and production lines. The companies have created openROBOTICS, a solution based on a full lineup of Comau robots that handle payloads ranging from 3 to 650 kg. “With completely uniform programming for every component in the line — including the robotics — our customers around the world gain the full benefit of holistic approaches to operation, diagnostics and maintenance,” says Tobias Daniel, head of sales and marketing at Comau Robotics. Traditionally, robotics and machinery have always relied on separate controllers or gateways.



**BEYTA GEAR SERVICE**

## PUTTING A LIFETIME OF GEAR DESIGN EXPERIENCE TO WORK FOR YOU

- Reverse engineering
- Gearbox upgrades
- Custom gearbox design
- Specification development
- Project management
- Vendor qualification

- Design reviews
- Bid evaluations
- Tooling design
- Customized gear training
- Equipment evaluation
- Custom machine design

**Charles D. Schultz**  
**chuck@beytagear.com**  
**[630] 209-1652**

**www.beytagear.com**

**Power Transmission Engineering**

## Power Transmission Engineering

- Technical content free for everyone
- Comprehensive Buyers Guide
- The latest news

**www.powertransmission.com**

# Interface Performance Materials

WELCOMES NEW PRESIDENT AND CEO

Interface Performance Materials, Inc., a global manufacturer of advanced materials, sealing solutions, thermal and acoustic management systems and specialty products, has named **Victor Swint** president and chief executive officer. Swint comes to Interface Performance Materials from Global Automotive Group, a division of Illinois Tool Works (ITW), where he served as group president. His prior professional experience spans more than 25 years and includes positions with Price Waterhouse Coopers, Monsanto, Emerson Electric, Danaher Corporation, Cooper Industries and Rockwell Automation. "I'm excited and honored to join the Interface team," said Swint. "I look forward to applying my past experiences and taking on new challenges as we tap into the talent here at Interface to expand our offering and capabilities." Swint earned a master's of business administration in general management from Harvard Business School and a bachelor of science in accounting from the University of Maryland. He also holds certifications in Value Stream Mapping, 5S, Single Minute Exchange of Dies (SMED) and Six Sigma.



## ABB

ANNOUNCES NEW MISSISSIPPI MANUFACTURING PLANT

Leading power and automation technology group ABB announced the company is locating its new manufacturing operations in Senatobia, Mississippi. ABB will establish operations in the 85,000-square-foot facility formerly occupied by Twin Creeks Technologies. The project will create 200 new jobs by its third year of operation, with another 100 expected to be added by the fifth year.

"I thank the ABB team for its commitment to creating 300 new job opportunities for Senatobia's workforce," Gov. Phil Bryant said. "ABB's decision to locate in Mississippi demonstrates to the world that we have the competitive advantages needed for success in today's fast-paced economy. I wish the company many successful years in North Mississippi."

"We are pleased to locate this manufacturing operation here in Senatobia," said Chuck Treadway, low voltage products, Americas' region division head. "We made our decision after an extensive search. We found that Tate County offered an excellent combination of skilled workers, quality of life and



a positive business environment." The Mississippi Development Authority (MDA) provided assistance in support of the project for infrastructure needs and workforce training.

"We salute our partners at the Tate County Economic Development Foundation, whose teamwork with MDA helped bring ABB to our state, creating hundreds of exciting career opportunities for the people of Tate County and North Mississippi," said MDA Executive Director Glenn McCullough Jr. "We look forward to ABB's successful growth in Senatobia."

## QA1

WINS COMPOSITES AWARD

QA1 won the Materials and Process Innovation Award from the American Composites Manufacturers Association (ACMA) during the 2015 Composites and Advanced Materials Expo (CAMX) in Dallas, Texas. CAMX, produced by ACMA and the Society for the Advancement of Material and Process Engineering (SAMPE).



Dave Knauff, engineering manager, QA1, Scott Neubauer, engineer, QA1 and Dr. James Nelson, senior product development specialist, 3M.

During CAMX, ACMA presents its Awards for Composites Excellence (ACE) to companies who implement innovation in three categories: composites design, manufacturing or market growth. QA1 won in the manufacturing category for its nanosilica infused resin for use in performance automotive carbon fiber driveshafts. They partnered with 3M to develop this exclusive Matrix Resin that has improved compressive strength, fracture toughness and reduced water absorption. These enhancements allow for redesign of composite structures, eliminating weight while improving strength and stiffness.

"3M and QA1 have worked hard to revolutionize the racing industry," said Jeff Lonergan, 3M advanced composites global business manager. "By working closely with QA1 engineers, 3M was able to provide new materials, processes, and recommendations to ensure success. The result of two years of testing and scale up have led to this industry recognized award."

QA1 manufactures carbon fiber driveshafts for drag racing, street performance and dirt late model racing. They are designed and manufactured in-house at QA1's Lakeville, Minnesota facility using the latest filament-winding equipment. QA1's carbon fiber driveshafts are lighter, stiffer and stronger

than aluminum, steel and other carbon fiber driveshafts, all while providing dramatic safety benefits.

“We build the best performing and most advanced driveshafts in the industry,” said Travis Gorsuch, director of advanced materials at QA1. “They have proven themselves on the track time and time again winning several championships across the country and it’s great to have them recognized by the composites industry as well.”

## Hydraulic Institute

ANNOUNCES THE RELEASE OF PUMP INDUSTRY STANDARDS

The Hydraulic Institute, North America’s largest pump trade association, announces the release of two final rules (1) The Energy Conservation Standard and (2) The Test Procedure for Commercial and Industrial Pumps by the United States Department of Energy (DOE). The rulings are now available through [www.pumps.org](http://www.pumps.org). The compliance date for the Energy Conservation Standard will be 2020 and DOE estimates it will save 0.29 quadrillion BTUs (2020–2050).



The final rules release is a culmination of more than five years of effort and negotiations between DOE and interested parties. The Hydraulic Institute and its membership advocated for the industry throughout the rule making process and played a significant role in their development.

**The Energy Conservation Standards Ruling:** In this final rule, the DOE adopts new energy conservation standards for pumps. DOE has determined that the new energy conservation standards for pumps would result in significant conservation of energy, and are technologically feasible and economically justified.

**The Pump Test Procedure Ruling:** The DOE is now authorized to prescribe energy conservation standards and corresponding test procedures for statutorily covered equipment such as pumps. Under 42 U.S.C. 6314, EPCA sets forth the criteria and procedures DOE must follow when prescribing or amending test procedures for covered equipment. EPCA provides that any test procedures prescribed or amended under this section shall be reasonably designed to produce test results that measure energy efficiency, energy use or estimated annual operating cost of a covered product during a representative average use cycle or period of use, and shall not be unduly burdensome to conduct.

## GET THE BIG PICTURE

Subscribe today!

## GLOBAL INDUSTRIAL OUTLOOK

Concise, visual, information rich analysis of global manufacturing demand and trends organized by geographic regions and key industry verticals. Built on proprietary, granular collection and organization of core growth trends in orders and sales from 55 key global companies.

Published Quarterly: February, May, August, November

Regular price: \$400 (only \$350 for PTE subscribers)

*Money back guarantee*

Langenberg &  
Company

Subscription requests to:

[Ewa@Langenberg-llc.com](mailto:Ewa@Langenberg-llc.com)

[www.Langenberg-LLC.com](http://www.Langenberg-LLC.com)

### USA

#### RESOURCES

Oil & Gas →  
Mining →

#### POWER & ENERGY

Generation →  
Transmission ↑  
Distribution ↑

#### TRANSPORTATION

Road →  
Rail →  
Marine →

#### MACHINERY

Construction ↑  
Mining →  
Truck →  
Agriculture →

#### AUTOMATION

Process ↑  
Industrial ↑

#### FLOW CONTROL

↑

#### IND. MACHINERY, GEN IND.

#### CONSTRUCTION

HVAC →  
C&I →  
Residential ↑

#### CONSUMER

Automotive ↑  
Appliances ↑  
Electronics ↑

#### AVIATION

Commercial ↑  
Military ↓

**March 2–5—The MFG Meeting 2016** Palm Desert, California. The MFG Meeting 2016 brings together a broad spectrum of manufacturing business owners and top industry executives for a four-day forum on how manufacturers can work together to restore manufacturing to its rightful place as an engine that drives the U.S. economy. Jointly produced by the Association for Manufacturing Technology (AMT) and the National Tooling and Manufacturing Association (NTMA), this event tackles the issues that affect the entire realm of manufacturing. In 2016, topics will include leadership, economics, cyber security, strategic succession and more. The focus will be on the next generation of manufacturing workers and the teamwork needed for future success. For more information, visit [www.themfgmeeting.com](http://www.themfgmeeting.com).

**March 15–17—Fundamentals of Gear Design** University of Wisconsin-Milwaukee, School of Continuing Education. Develop your understanding of the history, basic gear tooth nomenclature, types of gears, gear arrangements, theory of gear tooth action, and failure modes and prevention. This course was recently updated and expanded to comprehensively cover important topics relating to gear system design consideration. Attendees will build knowledge of modern gear system design and analysis, distinguish between types of gears and gear arrangements and discuss theory of gear tooth action and derive parameters as they're presented. Fee is \$1,095 by Friday January 15th and \$1,195 after January 15th. The class is taught by Raymond Drago, chief engineer for Drive Systems Technology, Inc. For more information, visit <http://uwm.edu/sce/courses/fundamentals-of-gear-design>.

**March 16–18—Introduction to Electric Machines and Drives** Madison, Wisconsin. In the last 30 years, the introduction of power electronic drives with motors has led to new design opportunities. The increased integration of these drives and machines has triggered a leap in productivity, efficiency and system performance. This hands-on course will give attendees a solid introduction in areas like AC systems and three-phase circuits, electromagnetics, basics of AC machines, induction motors, synchronous machines, converter power electronics and more. By participating in this course, attendees can earn 20 professional development hours (PDH) or 2.0 continuing education units (CEU). This event includes instructors from the University of Wisconsin-Madison, Ryan Consulting and UTC Aerospace Systems. It is a valuable course for those involved in appliance drives, cranes and elevators, precision motion control, electric/hybrid-electric vehicles, autonomous vehicle control and aerospace, marine and military vehicles. For more information, visit [epd.wisc.edu/RA01369](http://epd.wisc.edu/RA01369).

**March 22–23—AWEA Wind Project Siting and Environmental Compliance Conference 2016** Charleston, South Carolina. The AWEA Wind Project Siting and Environmental Compliance Conference bring wind industry leaders together for discussions about the current state of siting and environmental compliance and network. Key insights within energy development, operations, evolving trends and strategies for improving the project permitting process and maximizing the output of operating assets will be discussed. The program will be a good mix of state-of-the-art methods

for addressing ongoing challenges within the wind industry. For more information, visit [www.awea.org](http://www.awea.org).

**March 22–24—2016 Gearbox CSI: Forensic Analysis of Gear & Bearing Failures** Concordville, Pennsylvania. Instructors Raymond Drago and Joseph W. Lenski, Jr. help gear designers gain a better understanding of various types of gears and bearings. Attendees will learn about the limitation and capabilities of rolling element bearings and the gears that they support so they can properly apply the best gear-bearing combination to any gearbox, whether simple or complex. Gear design engineers; management involved with the design, maintenance, customer service and sales should attend this event. For more information, visit [www.agma.org](http://www.agma.org).

**March 22–24—Aggregates Academy & Expo 2016** Nashville, Tennessee. AGG1 is the leading aggregate exposition and educational resource brings together decision-makers and buyers from companies that produce crushed stone, sand and gravel in the marketplace. Sponsored by the National Stone, Sand & Gravel Association, AGG1 education tracks include sessions on operations, automation, safety and business management. Workshops include strategic sales training and basic supervisory training. The show is co-located with the World of Asphalt Show & Conference focusing in-depth, industry-focused programming in the asphalt industry. For more information, visit [www.nssga.org](http://www.nssga.org).

**April 4–8—2016 Basic Training for Gear Manufacturing: April** Chicago, Illinois. Instructors Dwight Smith, Pete Grossi and Allen Bird teach students the fundamentals of gear manufacturing in this classroom and hands-on course. This course offers training in gearing and nomenclature, principles of inspection, gear manufacturing methods, and hobbing and shaping. In the hands-on gear lab, using manual machines, students can see the interaction between the cutting tool and the workpiece. They understand the process and the physics of making a gear and can apply this knowledge in working with CNC equipment commonly in use. The Basic Course is designed primarily for newer employees with at least six months experience in setup or machine operation, it has also proved beneficial to quality control managers, sales representatives, management, and executives. For more information, visit [www.agma.org](http://www.agma.org).

**April 5–7—2016 Reliable Plant 2016** Louisville, Kentucky. This three-day event offers attendees learning sessions and case studies on the latest industrial lubrication and oil analysis technologies. The comprehensive conference schedule covers every facet of the machinery lubrication industry and includes workshops on topics such as employee performance, lubrication fundamentals, condition-based maintenance and maintenance planning. The 150,000 square foot exhibit hall, receptions and educational sessions facilitate networking opportunities as well as the implementation of new ideas attendees can bring back to their manufacturing facilities. Reliable Plant is focused on both entry level and management positions within the lubrication industry including engineers, plant managers, maintenance professionals, safety personnel, planners, quality managers and more. For more information, visit <http://conference.reliableplant.com>.

# 10

# Top Ten Reasons

to Buy Bearing Products and Services from

## An Authorized BSA Member Distributor

### 1 TRUSTED

(Name of Company) is a business you can trust. Selected by the best bearing manufacturers to represent them in your local market.

### 2 RELIABLE

You can rely on your Authorized BSA Member Distributor to support you with the right brands and the right inventories.

### 3 QUALITY

An Authorized BSA Member Distributor partners with the top quality manufacturers. They have been trained to properly store and handle the products, and they work to continuously improve their service to you.

### 4 SERVICE

Authorized BSA Member Distributors provide local sales support for bearing products made around the world and are available when you need them.

### 5 EXPERTISE

Your needs are supported by the Authorized BSA Member Distributor's factory-trained staff who know the products and how best to apply them to help you solve problems and lower your total cost of operations.

### 6 INVENTORY

Your Authorized BSA Member Distributor moves bearing products directly from the manufacturer to speed deliveries of needed product for your applications – your best choice for timely supply of product.

### 7 SELECTION

Authorized BSA Member Distributors access the breadth and depth of factory-fresh inventory to best suit your needs.

### 8 TECHNICAL SUPPORT

Only an Authorized BSA Member Distributor has direct access to the bearing manufacturer's vast technical resources for complete, accurate and timely solutions.

### 9 GENUINE

Your Authorized BSA Member Distributor gives you piece-of-mind that you're buying our genuine branded products.

### 10 WARRANTY

Buying products from an unauthorized source often voids the manufacturer's warranty. Buy only from Authorized BSA Member Distributors.



We build  
relationships

© 2016 Bearing Specialists Association

Visit [www.bsahome.org/who](http://www.bsahome.org/who)  
for a List of Authorized  
BSA Member Distributors

**The Specialist**  
*For Solutions you can trust*

Protect your company. Buy from  
Authorized BSA Member Distributors.

[www.bsahome.org](http://www.bsahome.org)

## CALL FOR PAPERS!

Are you sitting on an idea for a technical paper but wondering where to present it? Do you have one already written, sitting on your desk, gathering machine dust?

How about *Power Transmission Engineering*? We are always looking for gearing- and power transmission component-relevant technical papers for publication in the magazine and in its digital version. Having your work appear in *Power Transmission Engineering* guarantees you an audience of the most experienced and discriminating industry players. You say your work has not been peer-reviewed? Not a problem, as we are lucky—and thankful—to have on-hand some of the most experienced and brilliant minds in the industry—our technical editors. So if your work “passes muster” and is published, you’ll know you were reviewed by the best—and most demanding.

Chances are you’ll be creating the paper under the auspices of the company for whom you work or own, or for one of the various industry-relevant associations. That means they as well will bask in the reflected glory that accrues with publication in *Power Transmission Engineering*.

For publication guidelines and more information, please contact Jack McGuinn at [jmcguinn@powertransmission.com](mailto:jmcguinn@powertransmission.com).

### Arrow Gear

Inside Front Cover  
[www.arrowgear.com](http://www.arrowgear.com)

### B&R Machine and Gear

Page 3  
[www.brgear.com](http://www.brgear.com)

### Baldor

Page 33  
[www.baldor.com](http://www.baldor.com)

### Bearing Specialists Association

Page 61  
[www.bsahome.org](http://www.bsahome.org)

### Beyta Gear Service

Page 57  
[www.beytagear.com](http://www.beytagear.com)

### Circle Gear

Page 20  
[www.circlegear.com](http://www.circlegear.com)

### Designatronics Inc.

Page 7  
[www.sdp-si.com](http://www.sdp-si.com)

### Diequa Corp.

Pages 12, 31  
[www.diequa.com](http://www.diequa.com)

### Excel Gear

Page 13  
[www.excelgear.com](http://www.excelgear.com)

### Forest City Gear

Page 11  
[www.forestcitygear.com](http://www.forestcitygear.com)

### IDC-USA

Page 17  
[www.IDCSelect.com](http://www.IDCSelect.com)

### IMTS 2016

Page 25  
[imts.com](http://imts.com)

### Innovative Rack & Gear

Page 21  
[www.gearacks.com](http://www.gearacks.com)

### J.W. Winco

Page 31  
[www.jwwinco.com](http://www.jwwinco.com)

### Langenberg & Co.

Page 59  
[www.langenberg-llc.com](http://www.langenberg-llc.com)

### McInnes Rolled Rings

Page 16  
[www.mcinnesrolledrings.com](http://www.mcinnesrolledrings.com)

### Miki Pulley

Page 10  
[www.mikipulley-us.com](http://www.mikipulley-us.com)

### Motion Industries

Page 23  
[www.motionindustries.com](http://www.motionindustries.com)

### Nordex Inc.

Pages 14, 31  
[www.nordex.com](http://www.nordex.com)

### Noria Corp.

Page 35  
[conference.reliableplant.com](http://conference.reliableplant.com)

### Reliable Plant

Page 35  
[conference.reliableplant.com](http://conference.reliableplant.com)

### Schaeffler Group

Back Outside Cover  
[www.schaeffler.us](http://www.schaeffler.us)

### Schafer Industries

Page 5  
[Schaferindustries.com](http://Schaferindustries.com)

### SEW-Eurodrive

Inside Back Cover  
[www.seweurodrive.com](http://www.seweurodrive.com)

### Smalley Steel Ring Co.

Page 15  
[www.smalley.com](http://www.smalley.com)

### SDP/SI

Page 7  
[www.sdp-si.com](http://www.sdp-si.com)

### Zero-Max

Page 9  
[www.zero-max.com](http://www.zero-max.com)



# Power Transmission Engineering



**Power Transmission Engineering** is Your KEY to understanding Gears, Gear Drives, Bearings, Motors, Clutches, Couplings, Brakes, and other Power Transmission Components.

Unlock your FREE subscription by filling out this form.

## FREE SUBSCRIPTION

**1**  **YES** I want to receive/continue to receive **Power Transmission Engineering** FREE!  
 No thank you.

Name: \_\_\_\_\_ JobTitle/Position: \_\_\_\_\_  
(print)

Signature \_\_\_\_\_ Date: \_\_\_\_\_  
(required)

**2** → E-mail \_\_\_\_\_  
(So we can notify you when the online edition is available)

 **SAVE a TREE!**  
 I ONLY want the digital edition (e-mail required)

**3** → Please update your contact information or attach you business card here. (No Staples)

Company Name: \_\_\_\_\_  
Address: \_\_\_\_\_  
\_\_\_\_\_  
\_\_\_\_\_  
City: \_\_\_\_\_  
State/Province: \_\_\_\_\_ ZIP+4/Postal Code: \_\_\_\_\_  
Country: \_\_\_\_\_  
Telephone: \_\_\_\_\_ Fax: \_\_\_\_\_  
E-mail: \_\_\_\_\_  
Website: \_\_\_\_\_

**5** → My company's principal product or service is: \_\_\_\_\_

**6** → What is your primary job function responsibility? (Check one)

<input type="checkbox"/> Corporate Management (1)	<input type="checkbox"/> Quality Control (7)
<input type="checkbox"/> Plant Engineering (2)	<input type="checkbox"/> Factory Automation (8)
<input type="checkbox"/> Design Engineering (3)	<input type="checkbox"/> Maintenance (9)
<input type="checkbox"/> Marketing & Sales (4)	<input type="checkbox"/> Other (10)
<input type="checkbox"/> Manufacturing Engineering (5)	
<input type="checkbox"/> Purchasing (6)	

Is there a colleague within your company that might benefit from having their own copy of **Power Transmission Engineering** magazine?

Name: \_\_\_\_\_  
Title: \_\_\_\_\_

**4** → How is THIS LOCATION involved with power transmission products? (Check all that apply)

WE MAKE power transmission products (10)  
 WE BUY power transmission products (12)  
 WE SELL power transmission products (Distributors, sales reps. etc.) (14)  
 WE DESIGN products with power transmission components in them. (16)  
 Other (please describe) (15) \_\_\_\_\_

**DIGITAL SUBSCRIPTIONS**

**YES, I want to be notified each issue when *Power Transmission Engineering* is available online**

**YES, I would like to receive *Power Transmission Engineering's* monthly e-mail newsletter**

**YES, I would like to receive *Power Transmission Engineering's* twice monthly e-mail Product Alerts**

**YES, I would like to receive 3rd-party e-mails from *Power Transmission Engineering's* advertisers and partners**

**YES, I would like to receive subscription renewal notices by e-mail**

**No, I do not wish to be contacted by e-mail.**

**FAX TO 1-847-437-6618** or  
VISIT US ONLINE AT  
[www.powertransmission.com/subscribe.htm](http://www.powertransmission.com/subscribe.htm)

# Gyroscopes in Spaaaaace!

## Draper Laboratories Works Toward Safer Space Exploration

Alex Cannella, News Editor

Moving around in open space is a cautious endeavor. Without the luxury of gravity, the slightest push can send you twirling in circles or, worse, tumbling off into the unknown. Every motion must be thought out and deliberate, all the more so because our bodies take that luxury into account.

Because we've lived with gravity all our lives, every motion we make automatically adjusts for that extra bit of weight exerted on us. Space (and that weight's sudden absence), however, requires some adjustment. While tinkering on a satellite, you might find that your fine motor skills aren't quite as fine as they were on Earth as you reach to grab something and overshoot by a solid three inches.

So far, this hasn't been much of an issue. Most of humanity's work in space has been on the Moon, where gravity is at least still present, or around the International Space Station (ISS), where we can control the conditions astronauts operate under on the occasions they need to work outside the station and provide them with all manner of assistance, from handholds and tethers to robotic arms.

But NASA's upcoming efforts are increasingly taking place in the space between celestial bodies as opposed to on them. Their Asteroid Redirect Mission plans to move an asteroid into orbit around the Moon where astronauts will study it up close, while the long trip to Mars, whenever we take that leap, will see astronauts living in zero gravity for so long that their bodies will adjust to the lower gravity and begin to atrophy.

Now, astronauts aren't entirely helpless out in space. They have thrusters to get around in case of emergencies, but turning yourself into a human rocket is a brute force method of travel through space. Today's astronauts don't have a way of keeping themselves stationary while working short of bolting themselves down to something. Until we

have something that lets astronauts remain stationary and oriented properly, operating in open space is a dicey proposition.

Luckily, Draper Laboratories is working to give space exploration a higher degree of precision with two new technologies: the Variable Vector Countermeasure Suit (or V2 Suit for short) and a jetpack. Both projects showcase the control moment gyroscope (CMG), which has been used in spacecraft and the ISS for a while now, but has never been compact enough for personal use.

CMGs utilize a spinning rotor and motorized gimbals that tilt the rotor. When the rotor is tilted, it, in turn, rotates the spacecraft or, alternatively, can resist rotation. In the V2 Suit, CMGs are used to simulate gravity, adding that extra bit of resistance that our bodies are used to. It won't be enough to give astronauts the exercise they need to resist muscle atrophy, but by simulating the gravity we're used to, it will make jobs requiring fine motor skills easier. In the jetpack, CMGs are being used to precisely rotate astronauts into position, adding some fine-tuned control where current propulsion systems are lacking. Both technologies will further help space explorers maintain their position and attitude (what way they're facing) while they work and move around.

Draper's main challenge will be to shrink the CMGs to a manageable size while making sure they don't consume too much energy and can be used long enough without falling into a "singular configuration" to be practically used.

A singular configuration occurs when the gyroscopes start counteracting each other or one has just rotated as far as it can. The former would create a net motion of zero, while the lat-



ter would effectively cut off an entire direction of motion. The problem is more pronounced for smaller CMGs since their size means they can't turn as far before they hit that singular configuration.

Draper's plan is to use a four-gyroscope system, with three to handle pitch, roll and yaw and a fourth gyroscope held in reserve that the jetpack's programming would use as needed to prevent the abovementioned problems from occurring.

The minds at Draper Labs still have considerable amounts of work ahead of them before their prototypes become standard-issue equipment, but they also have an equally considerable amount of time. NASA's Asteroid Redirect Mission won't be happening until the "mid-2020s," and a manned trip to Mars is still eternally just beyond the horizon. But whenever we finally get there, the astronauts we send may boldly go with a fancy new gyroscope jetpack on their backs. **PTE**

**For more information:**  
Draper Laboratories  
[www.draper.com](http://www.draper.com)



STRESS

## Too much pressure?

Are you under pressure to reduce costs? We can help! Independent research has proven that the **MOVIGEAR®** Mechatronic Drive System from SEW-EURODRIVE reduces start-up and operating costs in material handling by 20-30%. **MOVIGEAR®** also substantially reduces your inventory with its ability to cover a broad range of ratios within a single unit. So, relax...we got this!



**SCHAEFFLER**



# **X-life™ Bearings for Gearboxes**

**More capacity.  
More rigidity.  
Less friction.  
Less downtime.**

X-life products from Schaeffler feature optimized roller geometries and raceway finishes that are so precise, their service life far exceeds the conventional standard — as much as 70% in the case of our cylindrical and spherical roller bearings.

**Bottom line:**

**Maximum efficiency for your gearboxes.**

**Only X-life. Only from Schaeffler.**

Need more details?  
Please contact us at [info.us@schaeffler.com](mailto:info.us@schaeffler.com)  
[www.schaeffler.us](http://www.schaeffler.us)

©2015

Superior-quality products.  
Comprehensive reliable solutions.

