

# Power Transmission Engineering®

AUGUST 2017

## COUPLINGS

Solutions for High-Tech and Harsh Environments



## BEARINGS

Software and Life Analysis

# Who says you need a brush to create a masterpiece?



## Brother Brushless DC Motors... redefining the art of efficiency.

- Virtually maintenance free; lubricated and sealed for life
- Extremely configurable; several shaft configurations and custom options available
- Highly efficient with quiet helical and hypoid gearing
- Very safe 12-48VDC motors with a wide speed control range

**brother**  
at your side

866.523.6283

BrotherGearmotors.com

Call us today for a sample gearmotor to try out.



# Power Transmission Engineering®

AUGUST 2017



[22]



[56]

## FEATURE ARTICLES

- [20] **Six Key Elements of Gearmotor Optimization**  
Ensuring reliable performance, increased efficiency and lowest total cost of ownership.
- [22] **Tailor-Made**  
The role of coupling technology in current developments in industry.
- [25] **Coupling Connection**  
Couplings and harsh environments.
- [28] **Getting to Know Your Bearing**  
Software design, analysis and calculation tools help solve today's engineering challenges.
- [56] **Pack Expo: The Push to Automation**  
Robotics are becoming more integrated in packaging equipment.

## TECHNICAL ARTICLES

- [34] **Ask the Expert**  
Formulas, calculations and recommendations.
- [36] **Baldor Motor Basics Series**  
This issue: Factors that determine industrial electric bills.
- [40] **Rolling Bearing Service Life Based on Probable Cause for Removal**  
A tutorial.

Vol. 11, No. 5. POWER TRANSMISSION ENGINEERING (ISSN 2331-2483) is published monthly except in January, May, July and November by Randall Publications LLC, 1840 Jarvis Ave., Elk Grove Village, IL 60007, (847) 437-6604. Cover price \$7.00. U.S. Periodicals Postage Paid at Elk Grove Village IL and at additional mailing offices. Send address changes to POWER TRANSMISSION ENGINEERING, 1840 Jarvis Ave., Elk Grove Village, IL 60007.

Randall Publications LLC makes every effort to ensure that the processes described in POWER TRANSMISSION ENGINEERING conform to sound engineering practice. Neither the authors nor the publisher can be held responsible for injuries sustained while following the procedures described. Postmaster: Send address changes to POWER TRANSMISSION ENGINEERING, 1840 Jarvis Avenue, Elk Grove Village, IL, 60007. ©2017 Contents copyrighted by RANDALL PUBLICATIONS, LLC. No part of this publication may be reproduced or transmitted in any form or by any means, electronic or mechanical, including photocopying, recording, or by any information storage and retrieval system, without permission in writing from the publisher. Contents of ads are subject to Publisher's approval.

# MASTA

CAE solutions for the design, analysis and optimisation of complex transmission systems trusted by engineers worldwide

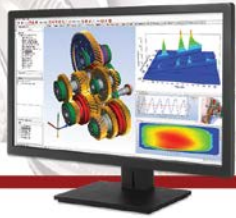

- Accurately and rapidly design and analyse transmission systems from scratch or troubleshoot existing designs
- Comprehensively understand the life of a mechanical part over the customer duty cycle
- Identify potential failure modes early in the development cycle
- Rapidly predict key performance characteristics at the design stage
- Easily explore changes in transmission layout, component selection and/or design, materials and manufacturing processes
- Perform full system simulations for any transmission or driveline configuration
- Incorporate manufacturing simulation at the design stage to reduce process development time & cost



Evaluate for free and discover more at [masta.smartmt.com](http://masta.smartmt.com)

Certified compatible with  Windows 10

© 2017 Smart Manufacturing Technology Ltd.

# SMT

# Power Transmission Engineering

VOL. 11, NO. 5

## [04] PTEExtras

Catch up — [www.powertransmission.com](http://www.powertransmission.com) — for latest videos, blog postings, social media and events.

## [06] Publisher's Page

Harvesting Knowledge.

## [08] Product News

**R+W** Disc couplings; **QuickSilver Controls'** improved driver design; **KISSsoft** intros rough sizing and unbalance response to shaft calculation.

## [32] Engineering sMART

Products and services marketplace.

## [52] Industry News

**Schaeffler** doubles down on innovation and product development in North America; **Parker** opens additive manufacturing facility; **Thomson Industries** collaborates with research team to develop new Tesla coil designs.

## [61] Calendar

**September 13-15:** 2017 VDI International Conference on Gears, Garching, Germany;

**September 18-22:** AGMA 2017 Basic Training for Gear Manufacturers, Oak Lawn, Illinois;

**September 25-27:** Pack Expo 2017, Las Vegas

**October 24-26:** Gear Expo 2017, Columbus, Ohio.

## [62] Advertiser Index

How and where to reach every supplier in this issue.

## [63] Subscriptions

Free subscriptions, anywhere in the world.

## [64] Power Play

Full Cinematic Immersion.

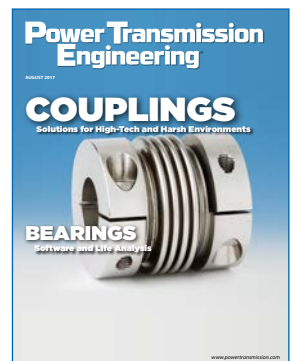

Cover photo courtesy R+W America



# C-FLEX

## BEARING CO., INC.

**THE LEADER IN FLEXING METAL TECHNOLOGY**

### C-FLEX LATTICE COUPLING

Our patented couplings provide superior performance at the lowest cost. The Super Plastic Couplings stabilize high precision systems by dampening transient torque variations.





### C-FLEX PIVOT BEARINGS

A flexure bearing providing precise rotation with low hysteresis and no frictional losses.

**Call today for details about incorporating the C-Flex products for more cost efficient, reliable product designs.**

**TEL: 315-895-7454 • FAX: 315-895-7268**

104 Industrial Drive, Frankfort, NY 13340

**C-FLEX.COM**

# The Original and Still Most Reliable



## Type E Bearing

When Dodge® created the Type E bearing in 1943, it quickly became the industry standard. And, after 74 years of improving and expanding the Type E, it has become the most widely used, reliable industrial bearing in the world.

Designed with innovative features to improve bearing life, reduce maintenance costs and simplify installation, our Type E family of bearings meets the needs for the most rugged, wet and dusty applications and environments. When you choose genuine Dodge Type E bearings you've chosen the original, unequaled bearing in the industry.

**baldor.com 479-646-4711**

- Introduced in 1943
- Proudly Manufactured in Marion, NC and Rogersville, TN
- Complete Inventory, Sales and Support
- Reliable and Safe for the Toughest Environments



### Editor's Choice: Engineering the New York Wheel

Check out our Editor's Choice Blog for the latest PT news including a look at the new observation wheel in New York City. See how Dana contributed driveshaft assemblies and gearboxes for the project at [www.powertransmission.com/blog/engineering-the-new-york-wheel/](http://www.powertransmission.com/blog/engineering-the-new-york-wheel/).



### PTE Videos:

We recently brought back Arrow Gear's video series on installing bevel gears. View these and other videos at the *Power Transmission Engineering* website: [www.powertransmission.com/videos/](http://www.powertransmission.com/videos/)



### E-News:

Each month, we'll bring you articles and information that's 100% relevant to you. The editors have scheduled a wide variety of topics for our upcoming newsletters, and by subscribing you'll get articles that don't appear anywhere else, not even in the print version. [www.powertransmission.com/newsletter/](http://www.powertransmission.com/newsletter/)

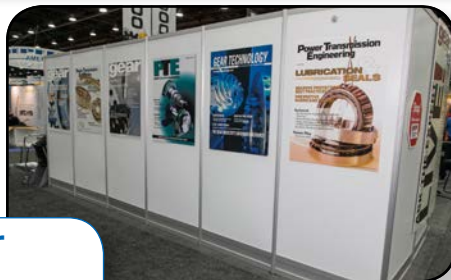

### Event Spotlight: Gear Expo

For three days, the full range of drive technology experts — design, manufacturing, application engineering, gear buyers and manufacturers — network and build relationships that benefit their respective companies. Learn more at [www.gearexpo.com](http://www.gearexpo.com).

### Stay Connected



Follow us on Twitter  
[twitter.com/#!/PowerTransMag](https://twitter.com/#!/PowerTransMag)



Connect with us on LinkedIn  
[www.linkedin.com/groups/Power-Transmission-Engineering-PTE-2950055](http://www.linkedin.com/groups/Power-Transmission-Engineering-PTE-2950055)



Subscribe Online  
[www.powertransmission.com/subscribe.htm](http://www.powertransmission.com/subscribe.htm)

## Power Transmission Engineering

### Randall Publications LLC

1840 Jarvis Avenue  
Elk Grove Village, IL 60007  
Phone: (847) 437-6604  
Fax: (847) 437-6618

### EDITORIAL

#### Publisher & Editor-in-Chief

Michael Goldstein  
[publisher@powertransmission.com](mailto:publisher@powertransmission.com)

#### Managing Editor & Associate Publisher

Randy Stott  
[wrs@powertransmission.com](mailto:wrs@powertransmission.com)

#### Senior Editor

Jack McGuinn  
[jmcguinn@powertransmission.com](mailto:jmcguinn@powertransmission.com)

#### Senior Editor

Matthew Jaster  
[mjaster@powertransmission.com](mailto:mjaster@powertransmission.com)

#### Associate Editor

Alex Cannella  
[alex@geartechnology.com](mailto:alex@geartechnology.com)

#### Editorial Consultant

Paul R. Goldstein

### ART

#### Art Director

David Ropinski  
[dropski@powertransmission.com](mailto:dropski@powertransmission.com)

### ADVERTISING

#### Advertising Sales Manager & Associate Publisher

Dave Friedman  
[dave@powertransmission.com](mailto:dave@powertransmission.com)

#### China Sales Agent

Eric Wu  
Eastco Industry Co., Ltd.  
Tel: (86)(21) 52305107  
Fax: (86)(21) 52305106  
Cell: (86) 13817160576  
[eric.wu@eastcotec.com](mailto:eric.wu@eastcotec.com)

#### Materials Coordinator

Dorothy Fiandaca  
[dee@randallpublications.com](mailto:dee@randallpublications.com)

### CIRCULATION

#### Circulation Manager

Carol Tratar  
[subscribe@powertransmission.com](mailto:subscribe@powertransmission.com)

#### Circulation Coordinator

Barbara Novak  
[bnovak@powertransmission.com](mailto:bnovak@powertransmission.com)

### RANDALL PUBLICATIONS STAFF

#### President

Michael Goldstein

#### Accounting

Luann Harold





## ***OFFSET SHAFTS. SOLVED.***

Offset Couplings from Zero-Max reduce space requirements for parallel offset shafts in large system applications. These specialized couplings provide machine designers with an important option for reducing overall machine size and footprint.

Compact in design, Schmidt Offset Couplings transmit constant angular velocity and torque in a wide range of parallel shaft misalignments. Handling high amounts of parallel offset up to 9 inches, they are available with torque capacities up to 459,000 in-lbs.

Schmidt Offset Couplings can be mounted to shaft hubs or directly to existing machine flanges. They are available for shaft displacements of 0.156 inches to 17.29 inches and torque capacities from 55 to 459,000 inch-pounds. Many design configurations are available including specials.



[www.zero-max.com](http://www.zero-max.com) 800.533.1731

**/////// ZERO-MAX®**

# Harvesting Knowledge

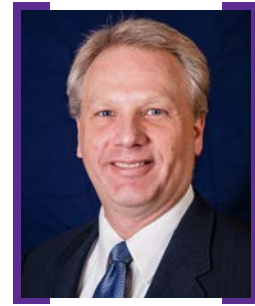

The season of harvest is upon us. And I don't mean crops, although here in the U.S. Midwest, there's plenty of that going on, too. No, what I mean is knowledge, because in addition to being the end of the growing season, the transition between summer and fall also marks the busiest time of year when it comes to trade shows, conferences and industry gatherings.

At our office we take that pretty seriously, because our whole business is about knowledge. We gather it, we study it, we distill it and we disseminate it. Learning things — and sharing what we've learned — is what we do. And there's no better place to learn things about technology than from the people who design, develop, test and build it.

So we've got a pretty busy schedule lined up over the next couple of months. Our editors and staff will be covering a lot of events, which includes a fair bit of traveling. For example, from Sept. 13–15, I'll be in Munich for the International Conference on Gears, where more than 140 speakers will present papers on the state of the art in every aspect of gear design, manufacturing and use. I have no doubt that some of what I learn there will make its way into the pages of *Power Transmission Engineering*.

Another key upcoming event is Pack Expo, which takes place in Las Vegas Sept. 25–27. We're especially excited about this year's show because the packaging machinery industry is one that continues to change, grow and modernize by integrating more sophisticated motion control and robotics into its equipment. We've already begun to describe some of these changes, and you can read about them in Alex Cannella's Pack Expo preview this issue on page 56.

Associate Publisher Dave Friedman will be traveling to Florida for the NIBA/PTDA Joint Industry Summit, the first time the Belting Association and the Power Transmission Distributors Association have held this event together. Taking place in Hollywood, Florida Sept. 27–30, this event promises to reveal much about the changing nature of the industry supply chain.

And then there's Gear Expo, which takes place Oct. 24–26 in Columbus, Ohio. If you are a buyer of gears or gearboxes, this is a must-attend event. More than 50 individual suppliers of gears and gear drives will exhibit at the show, right alongside the manufacturers of equipment and tooling for making gears. Gear Expo offers one of the most comprehensive educational programs at any trade show, with classroom-style offerings and a show-floor "Solutions Center". In addition, Gear Expo overlaps with AGMA's Fall Technical Meeting (Oct. 22–24), where the latest technical and research papers on gearing are presented every year.

On top of that, we'll be hosting a live version of our popular "Ask the Expert" column at Gear Expo, just like we did at the previous show two years ago. This educational event is designed to present both the basics as well as answers to complex design and manufacturing related problems. We've assembled a team of the most experienced and knowledgeable experts in the gear industry to sit on our panels, which take place on Tuesday, Oct. 24 and Wednesday, Oct. 25. If you're not already planning to go to Gear Expo, you should. We would love to have you come to booth #1020 to learn from our experts. It's your chance to ask your questions about gear design and manufacturing and have them answered in person.

If you can't make it to Gear Expo, you can still participate in Ask the Expert Live. Just send your questions to Senior Editor Jack McGuinn ([jmcguinn@powertransmission.com](mailto:jmcguinn@powertransmission.com)), and we'll ask the experts for you. Also, we will be video-recording the entire event and making it available on our website so that the information will be available to the widest possible audience.

We're doing everything we can to make the most of this harvest season. We're confident that the information we will be able to provide over the coming year will make it well worth the effort.

A handwritten signature in black ink that reads "Randy Stott". The signature is fluid and cursive, with the first letters of "Randy" and "Stott" being significantly larger and more stylized than the rest of the letters.



# Stock and Custom Mechanical Components One Convenient Source



Custom Design, Engineering & Manufacturing • Timing Belts and Pulleys  
Precision Gears & Gearboxes • Precision Machined Components  
Molded Components • Mechanical Assemblies

REGISTERED  
**ISO 9001**  
**AS 9100**

USA Manufacturer • Est. 1950



**We Provide Total Motion Control Solutions**  
Design ▶ Engineer ▶ Manufacture ▶ Assemble  
Ship Complete Subassemblies for a Wide Variety of  
Product Applications.

SETTING IDEAS INTO MOTION

**SDP/SI**

STOCK DRIVE PRODUCTS/STERLING INSTRUMENT

*Designatronics* inc.

Call our Engineers for a Design Consultation and Place Your Order Today.  
Phone: (800) 819-8900 Fax: (516) 326-8827 [www.sdp-si.com](http://www.sdp-si.com)

# Bega Special Tools

OFFERS MAINTENANCE OPTIONS FOR RAILWAY APPLICATIONS

At this year's Railway Interchange exhibition in Indianapolis, Bega Special Tools presented tools for easy and safe installation and removal of bearings and other transmission components in railway vehicles.

Rolling stock maintenance is an important part of the railway system. It is unthinkable what would happen if this was neglected: stalled trains would block rails and existing timetables would become a mess. This is why regular maintenance is necessary in order to maintain a reliable train park.

Engineers will recognize the risks they run into when confronted with stuck wheels or bearings. Cutting or grinding can be dangerous and can cause damage to shafts. Even the task of installing parts in a safe way can be a challenge. Having the right tools in a maintenance facility should be a priority to ensure reliability and personal safety.

Bega Special Tools is specialized in tools for removing and installing bearings and other transmission parts. A number of tools have been designed to remove and install railway bearing sets, gears, brake discs, labyrinth seals, bearing inner rings etc.

For removing and installing railway bearing sets and labyrinth rings, spe-



cial induction heaters can be used. Middle frequency induction heating technology is a safe and cost effective heating method that improves the quality of installation. Bega manufactures various models of the Betex MF Quick-Heater, which is also available in combination with fixed or flexible inductors.

The new generation Betex MF Quick-Heater 3.0 features smart electronics. With a compact design, it has a large touchscreen, a USB connection for software upgrading, and a log-in op-

tion for remote servicing. It heats according to a preset temperature/time curve and shows temperature development in chart form. There is an option of logging the heating cycle. Smart electronics ensure optimal operating frequency and advise the user on optimal heating, for example by suggesting more or fewer windings. The power control is adjustable, dual temperature sensing is available and there is an option to operate several heaters together.

For removing gears and train wheels, Bega supplies a unique series of self-centring hydraulic pullers, with capacities of 4 to 150 tons. These pullers are easy to use and require minimum setup time. Versions of dismantling wheels in combination with oil pressure are also available.

Exclusively designed for mounting and dismantling railway bearing sets, the Betex BPP/BPPS is a combined bearing puller and pusher.

All described tools and methods have one thing in common: they are designed to make the job easier, faster and above all safer. Flameless induction heating offers many advantages: safety, environmental friendliness, easy handling, no noise or pollution. Even reuse of parts is a real possibility.

**For more information:**

Bega Special Tools  
Phone: (516) 737-8012  
[www.begaspecialtools.com](http://www.begaspecialtools.com)





# WHAT DRIVES YOU

Join us at Gear Expo, THE Drive Technology Show, designed exclusively for the power transmission industry and drive technology professionals.

Drive home with new insights and technology for your business.



FOR MORE INFORMATION, VISIT  
[www.gearexpo.com/pte](http://www.gearexpo.com/pte)

## DISCOVER THE LATEST TECHNOLOGIES AND FIND NEW SUPPLIERS

**BRING YOUR ENGINEERING CHALLENGES** to a sold-out exhibit hall filled with the latest technology to make your products more efficient and cost effective.

**MEET WITH MORE THAN 200 COMPANIES** on the show floor covering the entire spectrum of gear and mechanical power transmission suppliers.

**DISCOVER THE LATEST TECHNOLOGIES IN GEARING SYSTEMS** while networking with thousands of design, project and manufacturing engineers that can drive profits for your company.

October 24–26, 2017

Columbus, OH  
Greater Columbus Convention Center



## EXPANDING YOUR EXPECTATIONS

McInnes Rolled Rings continues to expand not only our facility, but also your expectations of what responsive service should be. We're committed to the delivery of quality products with the fastest shipping times in the industry.

**Speed. Quality.**  
**McInnes Rolled Rings.**

**McINNES**  
**ROLLED RINGS**

1.800.569.1420  
1533 E 12<sup>TH</sup> STREET • ERIE, PA 16511  
[www.McInnesRolledRings.com](http://www.McInnesRolledRings.com)

## SKF

MULTILOG IMX-8 SYSTEM INTRODUCES COMPACT AND COST-EFFECTIVE MONITORING

The new SKF Multilog IMx-8 online system introduces compact and cost-effective technology for monitoring the condition of industrial rotating machinery. This versatile device offers eight analog output channels with connectivity to mobile devices and laptops for easy configuration and monitoring. The system equips users with a 24/7 monitoring solution to detect machine faults early, integrate automatic recognition to correct existing or impending conditions and contribute to condition-based maintenance program objectives.

Individual warning and alarm levels controlled by machine speed or load can be set for each measurement point. Built-in auto-diagnosis can check all sensors, cabling, and electronics for any faults, signal interruption, shorts, or power failure and then automatically alert when problems are found.

The IMx-8 features enhanced internal memory (4 GB) to enable stand-alone monitoring and logging of large amounts of data, which can be easily accessed for analysis following a critical event.



The IMx-8 is the newest addition to SKF's versatile IMx systems portfolio. Unlike its 16 and 32 channel variants, the IMx-8 takes up little cabinet space and is ideally designed for installation into instrument cabinet enclosures. Suitably housed, the system also serves space-restricted applications where instruments may need to be located close to the monitored machinery. The app-based configuration interface is especially user-friendly, allowing for setup with little or no previous experience. The IMx-8 is DIN-rail mounted.

The system's eight analog signal outputs can be configured for a variety of sensors to ascertain acceleration, velocity and displacement, among other

All IMx systems can run on an existing LAN or WAN and network with computers, printers, and servers or over the internet. The timely and true simultaneous measurements of the various operating parameters can guide in improving machine reliability, availability, and performance.

**For more information:**

SKF USA Inc.  
Phone: (800) 440-4753  
[www.skfusa.com](http://www.skfusa.com)



## R+W

DISC COUPLINGS OFFER INTEGRATED COOLANT TUBE

R+W has recently expanded its LP product line with a new disc pack coupling model. In addition to the wide range of standard designs, R+W can now supply a version with an integrated coolant tube. This offers many advantages to manufacturers of machine tools with long spindle drives.

This specially designed double disc spindle coupling can transport coolant directly to the cutting head over long distances using an integrated inner pipe, vertical support, and special adaptation interfaces on each end. Since these couplings are often used in highly dynamic and high speed applications, lightweight carbon fiber (CFRP) or aluminum spacer tubes are typically used. Symmetric conical clamping hubs along with fine balancing help guarantee smooth operation at high speeds. The torsionally rigid disc packs compensate for misalignment between the connected shafts.

This robust, high performance line of disc couplings provides users with a simplified spindle setup, reduced assembly times, faster operating speeds and longer tool life.

### For more information:

R+W America  
Phone: (630) 521-9911  
[www.rw-america.com](http://www.rw-america.com)



# The Power of One<sup>2</sup>

### Your Objective:

One face in perfect alignment with another. *For infinity.*

## No problems. No distress. No delays.

That's the same objective you have for choosing your gear producer. Circle Gear's objective is to engage with every customer's objectives.

- ▶ One to 1000 gears
- ▶ Customer designed or reverse engineered
- ▶ Gearbox repair, rebuild or redesign
- ▶ OEM or end-users
- ▶ ISO 9001:2015 Certified

1501 S. 55th Court, Cicero, IL 60804  
(800) 637-9335  
(708) 652-1000 / Fax: (708) 652-1100  
[sales@circlegear.com](mailto:sales@circlegear.com)  
[www.circlegear.com](http://www.circlegear.com)



Spiral and Straight Bevel Gears (*Cut, Ground or Lapped*) • Spur Gears • Helical Gears • Long Shafts • Herringbone Gears • Involute and Straight Sided Splines • Internal Gears • Worm and Worm Gears • Racks • Sprockets • ISO Certified



Partnering with QualityReducer to provide Gearbox repair, rebuilding and reverse-engineering.



Quality Solutions Since 1960



- Standard Components
- Made to Print Parts & Assemblies
- Design & Engineering

**Nordex.com**

sales@nordex.com  
eng@nordex.com

Phone: (800) 243-0986  
or Call: (203) 775-4877

## KISSsoft

INTRODUCES ROUGH SIZING AND UNBALANCE RESPONSE TO SHAFT CALCULATION

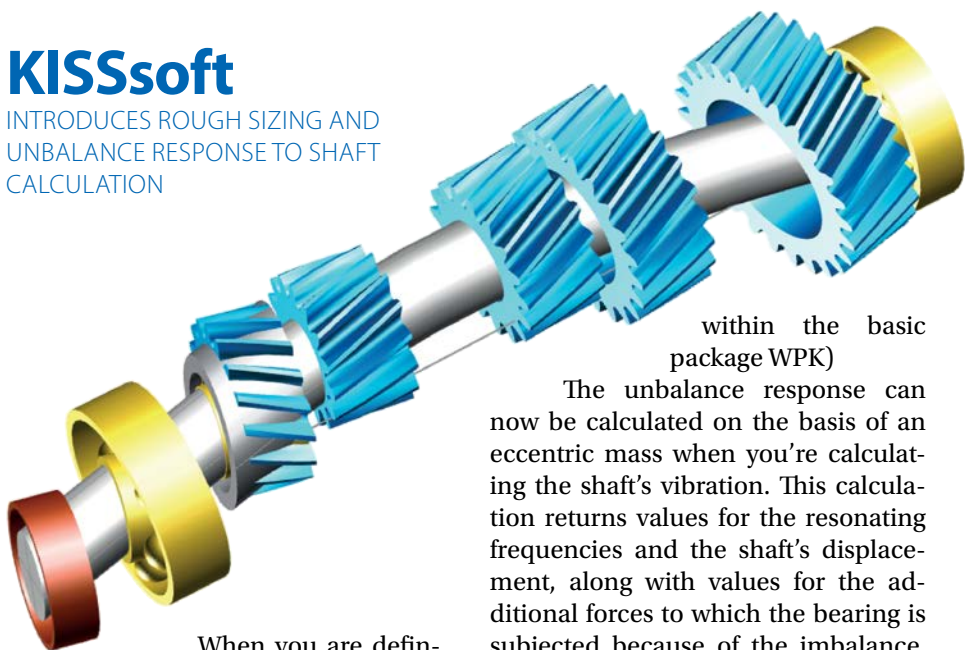

within the basic package WPK)

The unbalance response can now be calculated on the basis of an eccentric mass when you're calculating the shaft's vibration. This calculation returns values for the resonating frequencies and the shaft's displacement, along with values for the additional forces to which the bearing is subjected because of the imbalance. To help perform a realistic calculation of vibration, you can now enter the damping values individually. (New module WA11)

**For more information:**

KISSsoft AG  
Phone: +41 55 254 20 50  
[www.kisssoft.ag](http://www.kisssoft.ag)

When you are defining dimensions for shafts, KISSsoft now provides options for sizing shaft dimensions with regard to strength, and for sizing the rolling bearings with regard to bearing service life. This really cuts down the time you need to design a gear unit. Here, you can specify which priorities are to apply during sizing. (New functionality

## Allied Motion

HMP MOTORS OFFER COMPACT SIZES AND LOW PRODUCTION COSTS

Allied Motion Technologies introduces the HeiMotionPremium (HMP) brushless AC servo motor family. HeiMotion is available in five metric frame sizes with rated torque from 0.12 up to 14.4 Nm, and continuous shaft power from 50 W to 3.75 kW. It offers highly accurate torque ratings, energy efficiency and extraordinary durability (20,000+ hour life span). An innovative compressed winding technology allows for a compact size, as well as lower production costs compared to competitive motors. The series is highly configurable in thousands of combinations to fit virtually any application. It is engineered for use in the machine tools, autonomous vehicles, robots, medical di-

agnostic equipment and similar high performance applications.

Highlights include standard flange sizes, 40, 60, 80, 100 and 130 mm, top speed ranging from 2,000 up to 9,000 rpm, holding torque ranging from 0.18 up to 18.5 Nm, winding voltage choices ranging from 48 up to 560 V, optimized inertia and extremely low cogging torque. Optional features include: standard resolver or encoder (including single cable Hiperface - DSL interface), holding brake, and connector choices.

**For more information:**

Allied Motion  
Phone: (716) 242-7535  
[www.alliedmotion.com](http://www.alliedmotion.com)



# QuickSilver Controls

SERVOMOTOR FAMILY FEATURES  
IMPROVED DRIVER DESIGN

QuickSilver Controls, Inc. announced the release of their High Power NEMA 34 Integrated Hybrid Servo Family.

The integrated servo includes both an internal and external clamp, a 20A RMS, 40A peak driver operating from 12 v through 72 v. The SilverMax X-series includes expanded command and register space as well as many new commands and modes of operation.

Improved driver design provides extremely smooth motions from over a wide speed range. The internal permanent magnet, high pole count servo motor provides high efficiency and full power over a wide range of speeds. Available torque up to 3200 in-oz/22.5 Nm for direct drive applications.

## For more information:

Quicksilver Controls, Inc.  
Phone: (888) 660-3801  
[www.quicksilvercontrols.com](http://www.quicksilvercontrols.com)

# Twin Spring Coupling

RELEASES DATA ON DRIVETRAIN  
COUPLING TECHNOLOGY

Twin Spring Coupling—a New York startup—has released the data on their new drivetrain coupling technology's first commercial product the TSC8300.

The TSC8300 is warrantied to 300 ft. lbs. (407 Nm) of torque. It will allow customers with smaller torque requirements to also get increased torque flexibility in one product.

The patented technology will allow designers who use existing coupling technology like cardan, CV and universal joints to look at their designs differently.

“Increased flexibility with the same torque curves allows the designer/engineer to achieve increased reliability with little to no modification,” says Darren Finch CEO of Twin Spring Coupling.

The constant maintenance of the internals of a universal joint isn't a



The Original Right Angle Drive  
Proudly Made in the USA

ANGULAR  
Gear

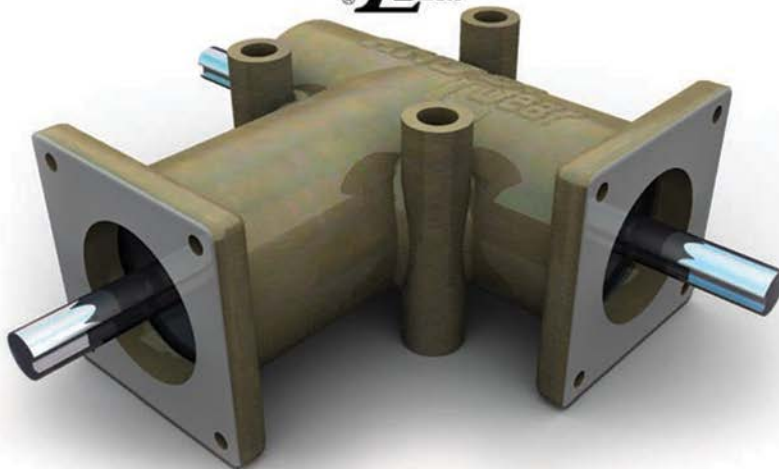

- Universal Mounting Positions
- Grease Lubricated for Life
- Completely Enclosed and Sealed Ball Bearings
- 1:1 or 2:1 Ratios; 2 or 3 Way Models
- Available in both Inch and Metric Dimensions
- Standard Models Modified to Fit Your Design Specifications

**ANDANTEX** USA Inc.

[andantex.com](http://andantex.com)  
[info@andantex.com](mailto:info@andantex.com)

Phone: 877-966-9151  
1705 Valley Road, Wanamassa NJ 07712

factor with this coupling as there are no internal components—no needle bearings to maintain, no bearings to wear out.

Applications include axle, PTO, drive shaft, steering, conveyor belts, belts, pumps, etc.

The simple design allows the coupling to be scaled up or down to suit the application and torque requirements. The flexibility of the springs allows for more movement without damaging the drive shaft or components. At the same time, it is able to absorb shock and energy, making the coupling more efficient.

“We are working on larger versions to handle over 500 ft. lbs. (674 N.m) and 700 ft lbs (950 N.m) of torque, and will



continue to develop our product line, working with customer and supplier needs,” Finch added.

**For more information:**

Twin Spring Coupling  
Phone: (718) 938-1950  
[www.twinspringcoupling.com](http://www.twinspringcoupling.com)

# The Full Spectrum

Gear solutions made easy with one of the most comprehensive and versatile gear reduction lines in the Metric market. With over 45 years of proven performance, Lafert’s power transmission products will let you push through even in the most demanding applications.

Right Angle Worm Gearboxes

Helical Inline Gear Reduction

Bevel Helical Gearboxes

Mechanical Speed Variators

Parallel Shaft Gearboxes

Shaft Mounted Gearboxes

Right Angle Worm Gearboxes

Bevel Gearboxes

Combination Right Angle Worm Gearboxes

Double Wormwheel Gearboxes

Shaft Mounted Helical Gearboxes

Planetary Gearboxes



Toll Free: 1.800.661.6413 | Fax: 1.905.629.2852  
[www.lafertna.com](http://www.lafertna.com) | [sales@lafertna.com](mailto:sales@lafertna.com)

Copyright Lafert North America 2013. All rights reserved.



## Celera Motion

INTRODUCES AGILITY SERIES SLOTLESS MOTORS

Ideally suited for scanning, pointing, measuring and cutting applications that require extremely smooth velocity control and highly accurate positioning, the Agility Series delivers best-in-class torque ripple and zero cogging.



Engineered with ZeroCog slotless motor technology from Applimotion, the effects of cogging torque, magnetic forces, flux harmonics and phase balance and alignment are minimized to counteract the causes of torque ripple. Agility magnetic designs and construction techniques can achieve less than 2 percent torque ripple.

The Agility Series is offered in a wide range of low-profile form factors with a large through hole for convenient



routing of cables, optics, sensing technologies and other system elements. Models are available in diameters from 12 mm to 300 mm, and with peak torques up to 41 Nm.

Frameless direct drive kit construction, high torque density and low mass enables Agility to be tightly integrated into compact, lightweight precision assemblies.

All models are compatible with a wide range of controllers and drives. Windings and form factors can be customized to meet application requirements.

**For more information:**

Celera Motion  
Phone: (781) 266-5200  
[www.celeramotion.com](http://www.celeramotion.com)

## IKO International

EXPANDS LINE OF DOUBLE HEX HOLE CAM FOLLOWERS

IKO International has expanded its line of CFKR series of Double Hex Hole Cam Followers. The outside diameter of the outer ring is now available in 22 and 26 mm, with current models as high as 90 mm.

These bearings are designed for outer ring rotation and have superior rotational performance with a small coefficient of friction and high load capacity. Consider the CFKR 90 V model, which features a dynamic load rating in excess of 67,000 N, compared to 40,500 N for similar cam followers on the market.



Because the structure of the CFKR series features hexagon holes on both stud ends, it can be tightened from the cam follower head or stud end. Variations are available for roller con-

struction (cage or full complement), shape of the outer ring outside the surface (crowned or cylindrical) and seal structure (shield or sealed type).

IKO's CFKR series meets the diverse needs of applications including transfer systems on machine equipment and production lines. Modifications can be made according to customer requirements.

**For more information:**

IKO International  
Phone: (800) 922-0337  
[www.ikont.com](http://www.ikont.com)

# SK

WHEN SAFETY IS A REQUIREMENT 0.1-2,800 NM.

**R+W**  
A POPPE + POTTHOFF COMPANY

[WWW.RW-AMERICA.COM](http://WWW.RW-AMERICA.COM)

# Bluegrass, Bourbon & Brakes

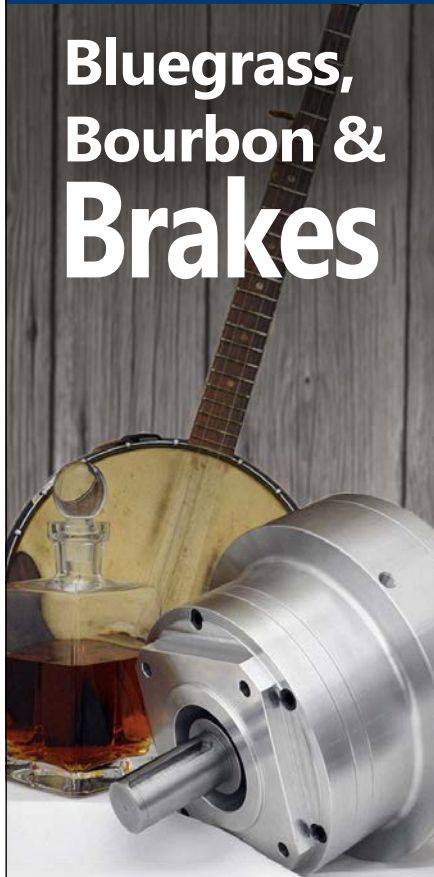

## Yes, Brakes

For 45 years, Mach III has produced made-to-order friction brakes, clutches and torque limiters that meet the exact requirements of our client's applications.

- 2,000+ models
- Torque to 60,000 in-lbs.
- Quick & reliable lead times
- Expert engineering help

Get to know another fine product from Kentucky.



859-291-0849  
machiii.com

# Stafford Manufacturing

OFFERS SHAFT COLLARS, COUPLINGS AND MOUNTS FOR DRONES AND UAVS

A broad range of standard and custom shaft collars, couplings, clamps, and mounts for attaching cameras, sensors, and other devices to drones and UAVs are being introduced by Stafford Manufacturing Corp.

Stafford Parts for Drones can include shaft collars, couplings, and flange mounts for attaching and repositioning structural components, cameras, sensors, and other devices. Featuring O.D.s as small as 0.500" and bore sizes from 0.062", they can be manufactured to specification from various materials such as aluminum, stainless steel, titanium, brass, and plastics.

Enabling OEMs to match design requirements for weight, strength, corrosion-resistance, and other factors, Staf-

ford Parts are suitable for commercial and military applications. Offered in sizes up to 6.00" I.D., depending upon configuration, collars and clamps are available in one-, two-piece, and hinged styles. Couplings and mounts also provide many design options. Stafford Parts for Drones are priced according to type, material, size, and quantity. Price quotations are available upon request.

### For more information:

Stafford Manufacturing Corp.  
Phone: (800) 695-5551  
[www.staffordmfg.com](http://www.staffordmfg.com)



# Drive Lines

COMBINES BEARINGS AND PROFILES FOR LIFTING APPLICATIONS

Combined bearings provide a cost-effective guide solution to lifting systems, platforms and cantilever loads. The system combines a radial bearing to take out high moment loads and a smaller axial roller to eliminate side movement. They are often used to guide screw jack lifting and sliding systems by isolating the screw jack drive from all side forces and moments, allowing for smaller and more cost-effective sizing of the screw jacks; especially under compressive buckling situations.

These combination bearings are often welded to a mounting flange plate for ease of fitment and replacement on the application. The flange plates offer a standard size with tapped and thru holes but square plates and special plates are available for ease of mounting. The flange plates are offered in standard rectangular sizes with tapped and thru holes but square plates and special plates are available for ease of mounting to customer fabrications.

The sealed and greased bearings offer robust guidance for fabrication mounting and with no external grease or oil required they are ideal for clean industrial environments. The bearings are designed to run in a hot rolled steel section in U and I configurations. These soft steel profiles are easy to machine, weld and integrate into fabrications and are sometimes used as structural members also due to the high rigidity of the sections.

For more precise applications or guidance, a complete precision rail and bearing combination is available. This is achieved by machining the inner radial bearing faces and back of the rail together with a larger diameter main radial bearing. The running tolerances are reduced which adds precision to the guidance. These sections are fine straightened and de-twisted before machining with counter bored, tapped, doweled or just clearance holes that can be precision machined along the rail lengths for mounting with fixings. Drive Lines has completed a number of high profile projects which utilized precision machine rails. These rails were machined to the clients drawing to provide a complete bespoke solution.

Drive Lines is also able to produce bespoke rail section extrusions and materials for special applications

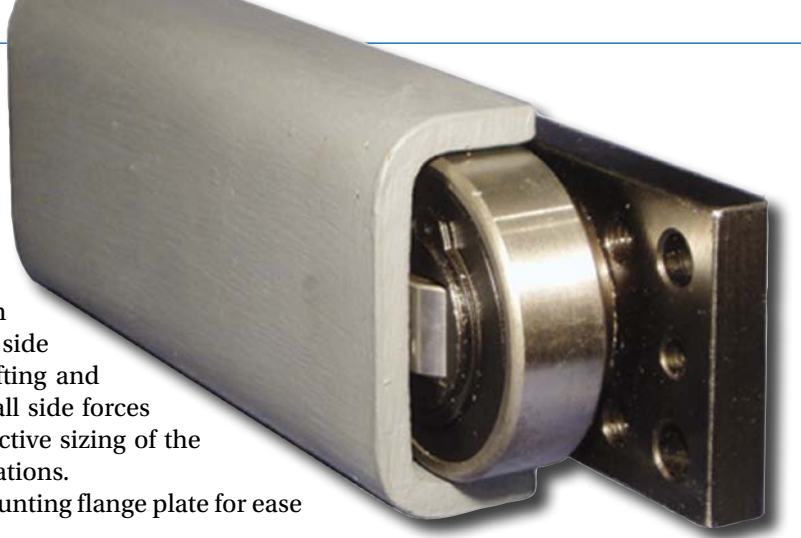

## Fast-Acting RELIEF

Forest City Gear has made the investment to cure your high-volume gear production challenges. Fewer headaches, better outcomes.

815.623.2168  
[www.forestcitygear.com](http://www.forestcitygear.com)



BOOTH #606



*Excellence Without Exception*



# MOLON

MOTOR & COIL CORPORATION



CERTIFIED  
ISO 9001-2015  
ISO 13485



## Motor Solutions Thru American Innovation

We don't leave the manufacturing and engineering of our products to other countries.

**AMERICAN  
MANUFACTURER  
EST. 1954**

VISIT OUR WEBSITE:  
[www.Molon.com](http://www.Molon.com)

where a unique profile or a different material such as stainless steel is required. The company can also offer bespoke short run extrusions for minimum quantities, offering the exact rail you need to suit your application with steel traceability, ultrasonic testing and other requirements available on request.

In difficult or corrosive applications Drive Lines can provide Armoloy thin dense chromium (TDC) coating for the bearings external parts or a full set of outer and inner needle roller components. Customers can hot dip galvanize or paint the rails, creating cost effective corrosion resistance.

In summary, combined bearings are a very versatile linear guide system for heavy duty fabrications and automation projects where robust, high load and sometimes bespoke solutions are required.

### For more information:

Drive Lines Technologies Ltd.  
Phone: +44 (0) 1234 360689  
[www.drivelines.co.uk](http://www.drivelines.co.uk)

## Kübler

OPTICAL ENCODERS DELIVER ACCURACY AND RELIABILITY

Kübler's newest series of Sendix F58 encoders combines certified EtherNet/IP support with patented mechanical and electro-optic technologies that ensure accuracy and reliability. These new optical absolute single- and multi-turn EtherNet/IP encoders have a diameter of 58 mm.

The Sendix F58 encoders have a RPI time as low as 1 ms, which allows them to transmit position data about 5 times faster than many conventional encoders. This speed advantage makes the F58 encoders particularly well suited to packaging, textile and printing applications—or any other application with fast machines that could be even faster with a position sensing upgrade.

EtherNet/IP also makes the encoders easy to commission because they look start up instantly as soon as they receive power and look for

their IP address settings and configure them via software. Due to EtherNet/IP's Device Level Ring feature, the F58 encoders will not lose communication in the event of a single cable break or signal interruption.

All four models in the F58 Series use Kübler's Safety-Lock bearing design, a mechanical design feature that protects bearings from wear or damage due to shock, vibration or misalignment.

### For more information:

Kübler Group  
Phone: (704) 705-4710  
[www.kuebler.com/usa](http://www.kuebler.com/usa)



# NKE

## ROLLING BEARINGS KEEP MOTORS AND GENERATORS RUNNING

Bearing manufacturer NKE Austria GmbH offers a wide range of rolling bearings for electrical machines. Particularly designed for motors and generators, the bearings are noted for their low running noise, efficient seals, high load ratings and long service life. NKE recently presented these bearings at the Electro-Mechanical Authority (EASA) Convention in Tampa, Florida, in June 2017.

Electric motors are the driving force behind most industries. In close cooperation with the customers, NKE develops bearing solutions for many types of electric machines, such as electric motors of various sizes and for various applications, e.g. vibrator motors, traction motors for rail vehicles as well as generators for hydro and wind turbines and UPS (uninterruptible power supply) systems.

The most commonly used bearing types in these applications are cylindrical roller bearings, deep groove ball bearings and angular contact ball bearings. Besides offering cost effectiveness, all bearings must operate with low noise, be durable enough to perform to the highest standards in long term operation and, for certain bearing types, have efficient seals.

Deep groove ball bearings are suitable for locating and non-locating bearing positions on small and medium-sized electric motors and generators, and for locating bearing positions on larger motors. They are ideal for high rotating speeds and moderate radial and axial loads. The bearings are quiet-running and economical. Besides the open configuration, they can also be supplied pre-lubricated with shields or seals.

### For more information:

NKE Austria (Ritbearing)  
Phone: (800) 431-1980  
[www.ritbearing.com](http://www.ritbearing.com)



PTC  
MDA  
ASIA

## POWER TRANSMISSION AND CONTROL 2017

International Trade Fair for Electrical and Mechanical Power Transmission, Fluid Power, Machine Parts, Fasteners and Springs, Bearings, Internal Combustion Engines and Gas Turbines

31 October - 3 November 2017 Shanghai New Int'l Expo Centre  
[www.ptc-asia.com](http://www.ptc-asia.com)



### For further information, please contact:

Deutsche Messe AG  
Messeplatz 1, 30521 Hannover, Germany  
Contact: Meike Sauer / Julia Bress  
Website: [www.messe.de](http://www.messe.de)

Tel: +49 511 89 34114 / +49 511 89 31118  
Fax: +49 511 89 39681

Email: [meike.sauer@messe.de](mailto:meike.sauer@messe.de)  
[julia.bress@messe.de](mailto:julia.bress@messe.de)

Hannover Milano Fairs Shanghai Ltd.  
Rm. 301 B&Q Pudong Office Tower 393 Yinxian Rd.  
Pudong Shanghai 201204, P.R. China  
Contact: Ms. Ally Huang / Ms. Sarah Shui / Ms. Lili Xu /  
Ms. Ivo Zhao / Ms. Sophia Bo / Ms. Sunny Sun

Tel: +86 21 5045 6700/252/225/264/215/322/251  
Fax: +86 21 5045 9955 / 6886 2355

Email: [ptc-asia@hmf-china.com](mailto:ptc-asia@hmf-china.com)  
Website: [www.ptc-asia.com](http://www.ptc-asia.com)

# Six Key Elements of Gearmotor Optimization

## How to Ensure Reliable Performance, Increased Efficiency and Lowest Total Cost of Ownership

Juan Avalos-Vasquez, Application Engineer, Brother Gearmotors

Choosing a gearmotor can be a relatively straightforward process, but engineers today are facing an expanded set of gearmotor requirements brought about by increased customer expectations. By knowing available input voltage, desired operating speed and torque requirement, one can begin to start in choosing an appropriate gearmotor. This paper will address those new enhanced requirements for not only the best performance and value option, but also increasing demands for lower operating costs, longer lifetimes and reduced total cost of ownership.

Gearmotors designed for high efficiency, installation flexibility and long life, maintenance-free operation can help achieve substantial cost-savings, avoid considerable downtime, and boost productivity well beyond what initially may have seemed possible. This is important considering that each piece of heavily relied upon handling machinery—including packaging equipment, conveyors, dispensers and sorters—benefits greatly from a cost-effective, energy efficient motor or gearmotor which, over an extended period, can lead to significant energy savings.

The more you know about the possibilities available to optimize your gearmotor selection, the greater your chances for making a choice that will be an enduring good decision for you and your customers.

### Six High-Performing Gearmotor Characteristics

#### High Efficiency Motors (NEMA Premium Efficiency or IE3)

Efficiency, even in small motors, is important because increased efficiency can result in cooler running, longer life motors that help enable you to reduce operating costs and more quickly recoup your initial investment through savings in electricity consumption. New U.S. government (DOE) regulations were enacted in 2016 that require most AC motors over one horsepower to be designed to meet premium efficiency standards. For equipment sold in Europe, it is necessary to meet similar IE3 efficiency standards.

To meet these higher efficiency standards, motors are redesigned with low-loss grades of steel for the laminations and higher copper content, thus offering at least 15 percent lower losses than conventional designs. This also keeps motor windings in good shape because insulation isn't exposed to unnecessary high temperatures.

High efficiency AC gearmotors offer application versatility. In fixed speed applications, the AC gearmotor size and ratio can be chosen to provide the desired output speed and torque capability when simply plugged into line voltage, without need for any other power supply or control. For truly optimized efficiency, a variable frequency drive (VFD) can be used to improve system efficiency further by using only what's necessary to run the specific application.

Additionally, AC motors are virtually maintenance-free, compared to brush DC motors. As a bonus, high efficiency motors operate at a lower skin temperature, making them safer for employees exposed to direct contact.

#### High Efficiency Gearboxes

Unless a “premium efficiency” motor is mated to a high efficiency gearbox, all the benefits can be lost. For example, right angle gearing is used in most material handling and conveyor applications. Traditionally, however, the predominant gear type used is worm gearing, the evolution of which goes back to Archimedes. Worm gear efficiencies drop as reduction ratio increases, to as little as 49 percent for a 300:1 ratio.

Worm gears also suffer from poor efficiency at reduced speeds—which are increasingly prevalent with the burgeoning popularity of Variable Frequency Drives (VFDs). Worm gears can decrease in efficiency by as much as 10 percent based on the input rpm. And, because worm gears use sliding friction, wear starts from first use.

A superior right angle gearing alternative is hypoid gearing technology, which can maintain efficiency above 85 per-



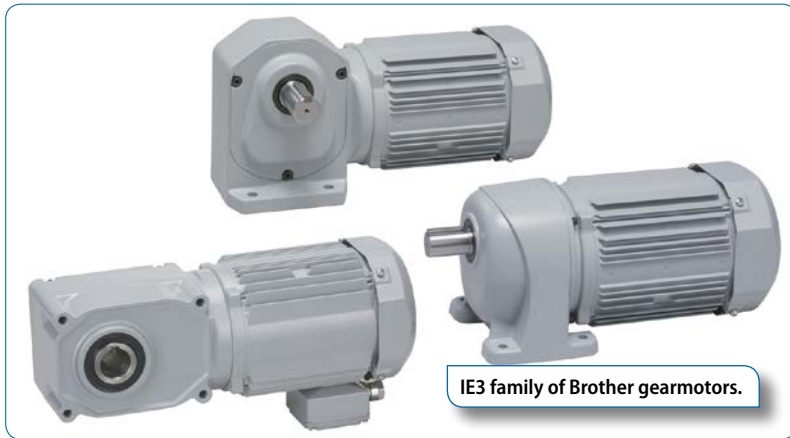

IE3 family of Brother gearmotors.

cent throughout the motor's wide speed range. By contrast, hypoid gears increase in efficiency when reducing the input rpm, making their use with VFDs more effective at transmitting power in low speed/high torque applications. Typically, an inefficient worm gearmotor can be replaced with a hypoid gearmotor, often with smaller motor power, and the result can be the same amount of torque. Hypoid gearboxes employ hardened, all-steel gearing and, therefore, offer significantly longer lifetimes than worm gearboxes.

Today, many companies are looking to maximize installation flexibility. Hollow bore hypoid gearboxes are often preferable, as they allow for direct machine mounting without using a chain and sprocket or another coupling. The hollow bore mounting reduces maintenance and parts count, and helps reduce cleanup in washdown applications since it minimizes areas where dirt and bacteria can harbor. In addition, hollow bore hypoid gearboxes help improve safety because the lack of chain and sprockets in the units results in fewer potential pinch points for workers.

**High-Grade Grease Lubrication**

To greatly reduce downtime and maintenance costs, some gearmotors are filled with high-grade grease that lasts for the lifetime of the gearbox and can greatly reduce downtime and maintenance costs, compared to oil or conventional grease. High-grade grease-filled gearmotors also enhance installation flexibility as they do not typically require breathers, enabling them to be mounted in any direction without designating a mounting position upon ordering.

**Triple Lip Shaft Seals**

Triple lip shaft seals can also help eliminate costly downtime, as they are preferable to dual lip seals for protection against lubricant loss and dust penetration into the gearbox. Keeping harmful dust out also prevents grease contamination, which often causes premature failures in bearings and seals. Additionally, keeping the lubricant sealed inside the gearbox helps avoid maintenance by prolonging the life of gears, seals and bearings. Safety also improves, since there is less chance for lubricant to leak from the gearbox, which can interfere with machinery operation or be a potential risk for employees working near the machinery.

**O-Ring Sealing**

Compared to gasket sealing, O-ring seals help lower maintenance costs by providing a more positive seal to prevent lubricant leakage from the gearbox case. O-rings also have a longer life than gaskets, since they are usually placed on an internal connection between the gearbox case and cover and are therefore not exposed to the elements. Gaskets, on the other hand, are typically at least somewhat exposed to outer elements and can be prone to deterioration.

**Protective Electrostatic Coating**

Many gearmotors operate in less-than-perfect environmental conditions, with exposure to dampness, dust, vapors and extreme temperature variations: all of which can lead to premature failure or other problems. This can be particularly challenging for conventional wet paint or even powder coat finishes. A better solution is electrostatic coating, often called e-Coat. It combines the best elements of plating and painting to provide a superior protective finish.

In the e-Coat process, motor components like castings, extrusions or other external metal parts are immersed in a water-based solution containing a special paint emulsion. An

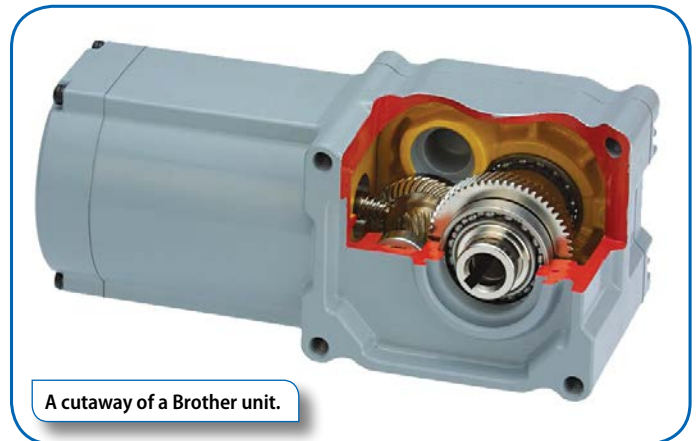

A cutaway of a Brother unit.

electric voltage is applied to the part causing the paint emulsion to condense onto the part, both inside and out. Thus, the part receives not only a fully protective coating, but is also fully insulated by the coating.

Gearmotors with this special electrostatic coating are protected from all kinds of environmental conditions, such as scratches/scrapes, caustic wash-down procedures as well as resistance to the harsh chemicals typically used in many processing plants.

In conclusion, it is possible today to do much more than turning a shaft when choosing a gearmotor. Knowing your options for enhanced performance, efficiency and lowest total cost of ownership allows you to make sure that your gearmotor choice is optimized to meet all your requirements. **PTE**

**For more information:**

Brother Gearmotors  
Phone: (866) 523-6283  
[www.brother-usa.com/gearmotors](http://www.brother-usa.com/gearmotors)



# Tailor-Made

## The Role of Coupling Technology in Current Developments in Industry

Frank Kronmüller, R+W Executive Vice President and Authorized Officer

The individually equipped car, one's own home or, most appropriate in the literal sense to this article's heading—the tailor-made suit: all are things that are designed according to one's own, quite special ideas.

What does this have to do with coupling technology?—A whole bundle.

Indeed, the solutions and processes in industry are becoming more and more individualized, driven by the increasingly varied requirements of users. Coupling manufacturers react and provide an active impetus with innovations of their own.

“Industrial production is characterized by a high level of customization of the products under the conditions of highly flexibilized (large-series) production,” according to the declaration of the Federal Ministry for Research and Education on the subject of Industry 4.0. Individualization and flexibility need freedom. Coupling technology is very closely intermeshed with the numerous industries for which it delivers solutions and opens up perspectives for future development. For the R+W Antriebs-elemente GmbH this means one is pleased to have access to the numerous technological possibilities that the company has acquired over the past decades—and at the same time is aware of the growing challenges—as well as the rising expense—that pertain to these requirements. Thus the standard product range is constantly expanding; more and more special solutions are being developed.

### Efficiency Stands in the Foreground

The starting point is the request from the design engineers. One first considers the overall context in order to understand what the user requires. What is the requirement? How can the couplings meet this requirement? Coupling manufac-



Figure 1 Precision safety couplings; e.g., the SK series, suitable for torques between 0.1 and 2,800 Nm (all photos courtesy of R+W).

turers must find and work out solutions for the existing demand. A wealth of ideas, seeing the big picture, and practical experience play an important role here. Over the years R+W has developed a wide range of standard solutions for precision and industrial drive couplings, enabling it to cover different applications directly.

R+W offers various solutions in the area of precision safety couplings; e.g., the proven SK series (Fig. 1), suitable for torques between 0.1 and 2,800 Nm. It is available for direct and indirect mounting by clamping hub, conical clamping ring or keyway mounting, and in a torsionally stiff, metal bellows version, as well as in a vibration-damping elastomer version (ES). The different models are available in each case with different operating principles: single-position, multi-position, load locking and with full disengagement.

To (address) the constantly changing requirements of the market, for example—lower mass moment of inertia, higher operating speeds or more efficient processes—R+W had already developed in 2010 lightweight safety couplings (SL Torqlight series) (Fig. 2), and thus set standards on the market. Torqlight has higher power density, lower weight, and costs less than the models of the standard series. R+W achieves this by intelligent, lightweight design in combination with high-tech materials using the latest manufacturing techniques. Such examples show how (ongoing) or completely new developments are constantly being added to the product range—thus responding to the needs of users with a view to functions, equipment and material used in production.



Figure 2 R+W lightweight safety couplings (SL Torqlight series) also provide higher power density at less cost than the standard series models.



Figure 3 Metal bellows couplings.



### Solutions for Production and Automation

Apart from the actual production processes, material flow and handling also profit from suitable coupling solutions. Torsionally stiff or vibration-damping zero backlash servo couplings are a natural for use in automation, since they fulfil the main requirements of highly dynamic servo-axes. Over the years, solutions from R+W have proven themselves a thousand times over in this area. The role in automation of metal bellows (Fig. 3), elastomer (Fig. 4) and safety couplings—as well as universal shafts (Fig. 5) for safe and in the final analysis efficient processes—is small in a physical sense, but significant as far as functions are concerned.

Applications that R+W cannot cover directly with a standard product require a special solution. The motto in the development department here is: as efficient as possible and as individual as necessary, to keep the investment and lifecycle costs within bounds for the customer. For example, in a comparatively short development time of a few weeks, the company developed a metal bellows coupling of press fit design for the largest machine in the world, the CERN research project, and a safety coupling for the ISS space station. A metal bellows coupling suitable for peak torques of up to 850,000 Nm was developed for wind turbines (Fig. 6)—clearly more than is possible with standard products.

Figure 5 Elastomer couplings.



### Mechanical Safety Couplings Fit for the Future

These practical examples demonstrate the relevance of coupling technology for numerous applications in different industries. To prevent damage to machinery, one also uses electrical versions. For example, (they are used) in machine and plant construction, apart from mechanically functioning elements; from current-dependent overload protection, through voltage and power monitoring components, and up to torque control devices. If one considers the two operating principles in detail, it becomes clear that mechanical elements have clear advantages compared with electronic control systems.

This is particularly evident in the response time of both versions. Here mechanical safety couplings are a few mil-



Figure 4 Safety couplings/universal shaft.

liseconds faster and thus clearly better. Finally, speed is the decisive factor in safety systems. The faster the control shuts off, or the component interrupts torque transmission, the less consequential is the damage to the components or even to the entire machine. When it comes to protecting investments and avoiding downtimes, fractions of a second are decisive. Mechanical safety couplings give users a valuable advantage.

Another advantage of mechanical safety couplings is that they have a lesser number of possible sources of error. In order to equip plants with electronic controls, a multitude of sensors is necessary to ensure optimal protection. In addition to the sensors, torque-measuring instruments are fitted at important places within the system. This arrangement of several safety devices accounts for sources of error, and the system must be maintained on a regular basis. In addition, sensors offer no absolute guaran-

tee of safety, for correct operation cannot be guaranteed due to dirt, deflection of infrared rays or masking of the sensors, for example.

Mechanical safety couplings also win due to their ease of use and easy adjustment. If, for example, the mass moments of inertia in the entire drive line are too high—so that the safety coupling would respond regularly when decelerating and accelerating the drive line—then the disengagement torque can be adapted to the circumstances without difficulty, thanks to the large adjustment range. Thanks as well for the variable installation possibilities; design engineers can use the coupling exactly at the place in the drive line where the probability of an overload is the greatest.

### Safety through Quality

Against the background of the subject of “safety,” the requirements on quality are correspondingly high. R+W responds to this challenge by employing in-house test stands (Fig. 7) that provide speedy feedback between quality assurance and development. On this basis, quality and functionality can be assessed, documented, and, if necessary—improved. The test stands offer testing capacities for different applications to obtain the wanted data as quickly as possible. R+W operates four types of test stands: a vibration test stand; one for universal shafts; one for special applications; and a heavy-duty test stand. The test stands deliver reliable results in the shortest time and under the company’s own roof.

Couplings are designed in a dialogue with customers according to their specific requirements. In close contact with the engineers of the user companies, R+W develops and improves its products continuously in order to offer specific solutions to meet the requirements in each case. The company’s own R&D department and prototyping, in co-operation



Figure 7 R+W utilizes in-house test stands to ensure timely feedback between quality assurance and development.



Figure 6 Developed for wind turbines, a metal bellows coupling suitable for peak torques of up to 850,000 Nm.

with universities and colleges of applied science, also makes its contribution. It is a question of solutions that provide a secure investment in the efficiency and reliability of equipment. Technological competence in the field of couplings and consideration of the customer’s application form the basis for the correct and best solution.

### Freedom for Innovations

In the so-called “Internet of Things,” objects like machines and robots exchange information among one another and make it available to mankind. Numerous new opportunities have opened up with a view to further developments and innovations. With regard to the demand for increasingly strong individualization of products and flexibility of production capacities, networked and highly automated production assures companies competitiveness in high-wage environments.

Whether standard or special solutions, couplings play an important role today, and in the future, for flexible, efficient, and intelligent processes. **PTE**

#### For more information:

R+W America  
Phone: (630) 521-9911  
[www.rw-america.com](http://www.rw-america.com)

**Frank Kronmüller**, R+W  
Executive Vice President  
and Authorized Officer



Reprinted with permission of R+W Coupling Technology.

# COUPLING CONNECTION

## COUPLINGS AND HARSH ENVIRONMENT USE

Jack McGuinn, Senior Editor

Simply defined, a coupling is a device used to connect two shafts together at their ends for the purpose of transmitting power. The coupling has been around since shortly after the invention of the wheel, i.e. — no wheel, no coupling. And something that has been around even longer than that is the often harsh and extreme environments in which couplings are at times required to function. Considering the seemingly endless list of coupling applications — from mining to the space station — it’s a given that couplings are often subjected to, among other things, extreme heat, cold, sand and degraded lubrication.

Some high-temperature examples:

- Degradation of a coupling’s elastomer inserts, thus reducing torque capacity
- Grease from gear and grid couplings can start to break down
- The adhesive used in bonded couplings may weaken due to extreme conditions
- Heat-induced thermal shaft expansion can place axial loads onto disc couplings (high-performance motion control couplings that serve as the torque-transmitting element)

Regarding low-temperature extremes, the effects are very similar to extreme heat; e.g., plastics (elastomers) become brittle; adhesive and lubrication break down.

And then there is commonly harsh chemicals exposure that, like the elements, weakens the aforementioned elements that constitute a coupling.

And last — wash down — during which precious grease can be blown free of gear and grid couplings.

We talked to two companies that know bearings — R+W Coupling Technology and Nordex, Inc. Joining in are Nordex mechanical engineer Nicholas Antonelli, and Andy Lechner, sales & marketing manager, R+W Coupling Technology.

While several topics are raised, coupling performance in harsh environments is the focus.



Andy Lechner



Nicholas Antonelli

**Say a customer is specifying couplings for a new “high-temperature” application, with the desired maximum allowable high temp yet to be determined. Who in a scenario like that assumes R&D responsibilities?**

(It’s) typically a joint effort between Nordex and our customer,” says Antonelli. Lechner adds that “For a manufacturer to determine if a custom solution can be provided, it’s necessary for the customer to identify the parameters;

WORLD LEADING  
INSPECTION & TESTING

SUPER PRECISION  
CUSTOM BEARINGS



**GEAR EXPO 2017**  
EXHIBITOR  
VISIT US AT BOOTH #532



✓ SOURCE QUALIFICATION, FAILURE ANALYSIS  
REVERSE ENGINEERING INSPECTION

✓ ENDURANCE, ENVIRONMENTAL,  
IMPACT/STATIC LOAD TESTING



✓ CORROSION RESISTANT, HIGH TEMPERATURE,  
HIGH FATIGUE LIFE BEARINGS

✓ SHORT LEAD TIMES, SMALL PRODUCTION  
RUNS, COST-EFFICIENT SOLUTIONS

Napoleon Engineering Services - Visit us at [nesbearings.com](http://nesbearings.com) or call (877) 870-3200

he needs to fulfill to achieve the application's desired result."

**Are there any new material breakthroughs that you are aware of; materials that might open new opportunities for plastic-for-metal couplings and components?**

"Yes, new materials such as Dupont Zytel and Hytel," Antonelli says. R+W's Lechner recalls that "A few years back, R+W developed a glass-reinforced, nylon hub material for corrosion proofing elastomer couplings without going to relatively more expensive stainless steel materials. Quite a lot of research went into designing specific hub structures to tolerate high torques in smaller sizes, and to maintain precision geometry. The product line has been a success — especially for outdoor applications."

**How does future 3-D printing work for coupling makers? Is additive manufacturing technology embraced by coupling manufacturers? Can they afford not to?**

"Additive manufacturing is an increasingly attractive means of rapid prototyping for new designs," Lechner points out. "Some opportunities exist to take advantage of the same for low-quantity production runs of otherwise capital-intensive production processes. Still, so many varieties of simple, flexible couplings already exist at low costs that it would take a completely new and uniquely beneficial design concept — best mass-produced by 3-D printers — for it to become a truly viable option for the coupling industry. So far, I'm unaware of such designs; however as the speeds, materials and costs continue to improve, it's candidacy for mass-production of couplings does as well." "(Three-D) printing can aid prototype development/testing," says Antonelli. "Also, the new polymers previously spoken about are available for 3-D printing."

**Even in harsh environments, can breakdown of elastomer inserts be avoided with robust preventive maintenance schedules?**

"Possibly," says Antonelli, pointing out that "it is dependent on duty cycles and usage." For Lechner, "Up-front coupling selection and installation are the highest predictors of long life as required torque and shaft alignment are the critical elements for minimizing wear. Many different materials are available for elastomer inserts, with the most commonly used by R+W being thermoplastic polyurethane. When properly aligned and installed — and with the torque and temperature ratings not exceeded — they require very little maintenance and can run for years without the need to replace them."

**Is lubrication as critical to couplings as it is, for example, gears and bearings — and even more so for harsh environment applications?**

Lechner says "The most commonly used coupling which requires lubrication is actually the gear coupling. As the teeth rock back and forth with each rotation, it is critical that friction be kept to a minimum. Proper maintenance

intervals should be observed, and in cases where that's impractical, maintenance-free couplings should be considered." Nordex's Antonelli explains that "In many cases, materials such as Delrin have a built-in lubricity."

**There seems to be almost as many applications for couplings as exists for gears. Can you think of one (coupling application) example that most people would not be aware of?**

Lechner says "Just about anything that rotates could use a coupling, depending on how things are laid out, so I'm not sure what applications would be surprising to people. One unusual application R+W worked on though was a torque limiter for disengagement at 18 million Nm, which is being used for gearbox testing for large offshore windmill applications." Antonelli adds, "Extreme angular change, such as using this feature in place of a right-angle gear box."

**How is adhesive used in a coupling? Is conditions-induced adhesive breakdown an expensive problem?**

Lechner: "In cases where the coupling will be deployed in corrosive environments or be subjected to temperature extremes — either of which can cause the bond to break down — welded bellows-hub connections are preferred. With some exceptions, most bellows used in shaft coupling applications are made from one or more layers of high-grade, stainless steel sheet; formed and plasma-welded into a seamless tube, and either rolled or hydro-formed to produce the deep corrugations (convolutions) which provide its flexibility. The resulting shape is one which is continuously symmetrical and highly rigid about its rotational axis, while remaining flexible across all three other axes: parallel, angular and axial. Bellows are joined to the hubs by crimping, welding, or bonding. The end hubs and bellows are mounted onto a single mandrel during assembly, with the ends of the mandrel matching the respective bore diameters of the coupling hubs, guaranteeing concentricity. Bonding came into common practice in the late 1980s, with the advantage being that it allows for the bellows to be floated between the two hubs, free of stress, until the bonding agent cures. This helps to avoid deformation or stress concentration on the bellows, ensuring that it will run smoothly, with consistent output rotation, once installed." Antonelli: "In bellow couplings an adhesive is often used to bond the flexible stainless bellow element to the aluminum or steel hub. The torque capacity of this connection is usually a multiple of the capacity of the bellow. If applied properly and used in the proper environment, adhesive breakdown is rarely an issue."

**Assuming excessive heat is the common culprit for thermal shaft expansion, how is it prevented?**

"As metals heat up they have a tendency to expand," says Lechner, "and in the case of power transmission shafting the result is often an elongation of the shaft. The amount of elongation which can be expected depends on the

material and the physical size of the shaft, with more movement to be expected from larger and longer shafts. In some cases it's necessary to absorb this axial pressure, and couplings which can tolerate axial misalignment are a common solution."

**Even in harsh environments, can breakdown of elastomer inserts be avoided with robust preventive maintenance schedules?**

"Many different materials are available for elastomer inserts, with the most commonly used by R+W being thermoplastic polyurethane," says Lechner. "When properly aligned and installed—and with the torque and temperature ratings not exceeded—they require very little maintenance and can run for years without the need to replace them."

**Environments like excessive noise and/or vibration—is either a major consideration in coupling design and performance?**

It's a "Yes" for Antonelli, adding, "This is speed-dependent, of course. And for Lechner, "Depending on the application, vibration can be a major concern for couplings. Reciprocating loads like combustion engines and some pumps and compressors require couplings to be able to absorb high amplitude torsional vibration and normally use very soft compensating elements. Conversely, servo applications typically call for a torsionally stiff coupling

to prevent vibration resulting from a need to rectify velocity and position errors which can result if the load inertia will have a delayed back-driving effect on the motor shaft as a result of torsional softness."

**With the advances in mechatronics and industrial automation (IIoT, etc.) how do coupling makers work with system integrators to ensure seamless design and performance—even in challenging conditions?**

"One way in which R+W helps to ensure seamless design and performance is through its sizing verification tool, which allows users to enter inputs based on the drive and application parameters and then test various coupling sizes with pass/fail results," Lechner says. "This helps to speed up the process when compared with long-hand sizing calculations. Another timesaver R+W offers is a CAD configuration portal, which allows the user to enter bore diameters and other options and then directly insert couplings into their models." **PTE**

**For more information:**

Nordex, Inc.  
426 Federal Road  
Brookfield, CT 06804  
Phone: (866) 931-0582  
Fax: (203) 775-6552

R+W America  
1120 Tower Lane  
Bensenville, IL 60106  
Phone: (630) 521-9911  
info@rw-america.com



# DieQua offers more gearboxes

## Are You Selecting The Right Technology?

Whether your application is for precise motion control or for general power transmission, there are several gear technologies that can do the job. But which one does it best?

Only DieQua offers the widest range of gearmotors, speed reducers and servo gearheads along with the experience and expertise to help you select the optimal solution to satisfy your needs.

**If you are using gearboxes, you should be talking to DieQua!**

**DIEQUA**  
Corporation  
www.diequa.com 630-980-1133

Power Transmission Solutions

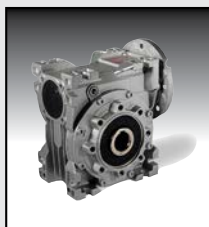

Worm Reducers

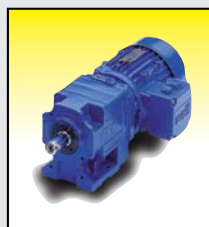

Helical Gearmotors

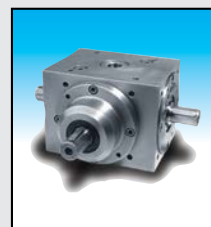

Spiral Bevel Gearboxes

Motion Control Solutions



Planetary Gearheads

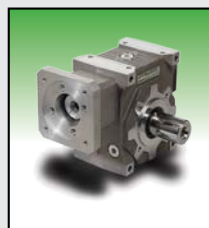

Servo Worm Gearheads



Precision Cycloids

# Getting to Know Your Bearing

## Software Design, Analysis and Calculation Tools Help Solve Today's Engineering Challenges

Matthew Jaster, Senior Editor

**I had questions about my bearings. Well, not my bearings per se, but bearings in general.** In order to properly discuss temperature, speed, power loss, fatigue life and lubrication in the eyes of the end user, I spent two hours online with Travis Shive, application engineer, industrial division at SKF to see how simulation tools really work in mechanical power transmission applications.

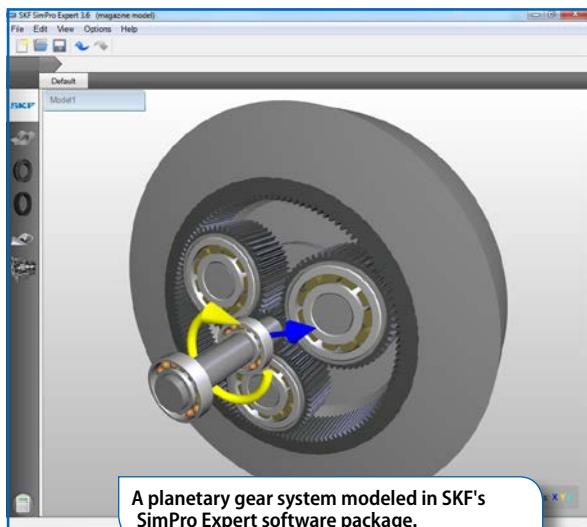

We eased into the engineering with a bearing selection tool, first. Very cut and dry. Enter the data you need, select the bearing that best fits your requirements, rinse and repeat. *Bearing Select* would eventually evolve into the company's *SimPro Quick* software, our second stop on the guided tour.

SKF *SimPro Quick* is a single-shaft bearing simulation software developed to quickly evaluate the design of bearing arrangements and their field performance, based on relevant application requirements and conditions. The tool aims to provide customers with more engineering knowledge and autonomy to accelerate the design process. This was followed by a short tutorial on SKF *Beast*, an internal software program that does a little bit of every-

thing, especially the more complicated bearing simulation scenarios.

The point of this online exercise was to get a sense of the storytelling going on inside the bearing.

While I deal in sentence structure, words and phrases, engineers at SKF, Schaeffler, Timken, Romax and KISSsoft have their own unique way to tell a story. They utilize computer screens, simulation models and field data to make it easier and more efficient for design engineers to make informed decisions regarding their applications.

### Instant Gratification

In the past, bearing calculation and simulation was a particularly lengthy process (it still can be depending on the programming requirements), but technology has come a long, long way in giving engineers immediate results and feedback.

"The immediacy is so important today for the design engineer," says Shive.

"End users can build their design at their location and have something up and running right away. Here's my shaft. Here are my bearings. What are my results? This is one of the key elements in bearing design today, the ability to make a decision immediately based on the simulation."

Just making the CAD drawings available is a significant step in the right direction, according to Brian Ray, chief engineer—industrial and application engineering at Timken. "Our CAD downloads are just one example of how we are sharing our bearing knowledge to help customers effectively select and design our products to their applications. It also provides insight on what

customers are looking for and what information to add to our website in the future," Ray said.

Carlo Bianco, global bearing team leader at Romax, said that in the challenging loading environment of today's transmissions, capturing potential bearing issues early in the development process is a major benefit. This

RomaxDesigner software examines various types of bearing stress.

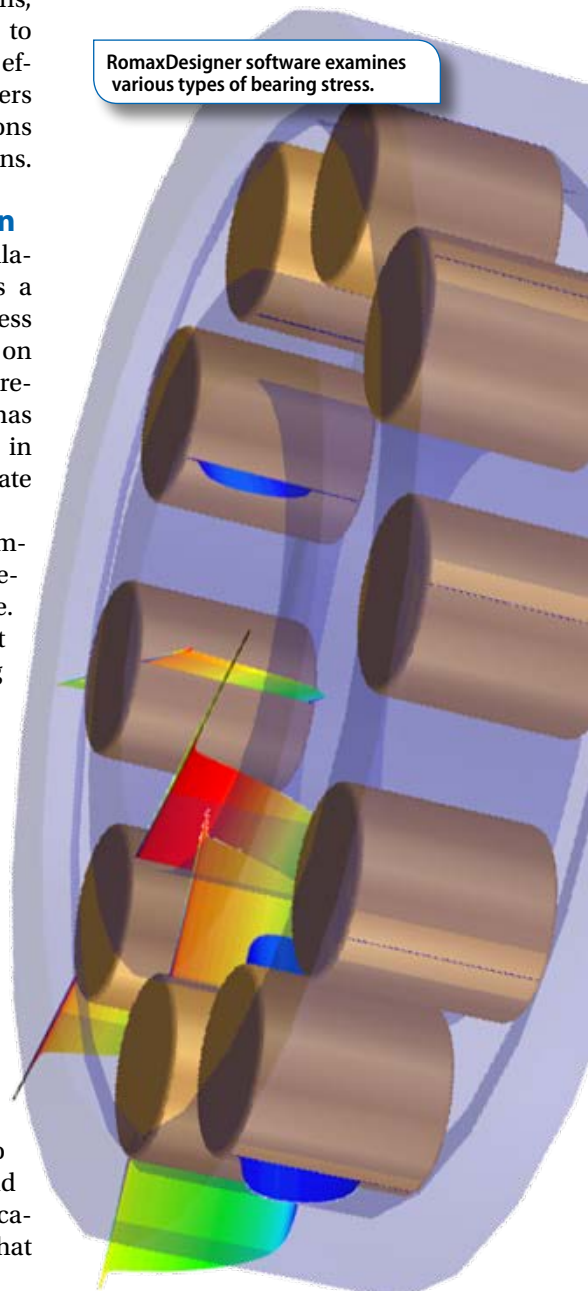

has been the driver behind key developments in *RomaxDesigner (R17)*.

“R17 includes the rapid and accurate prediction of bearing roller contact and edge stresses, improved simulation of the effect of variable roller rib contact height and new, predictive, hydrodynamic simulation of journal bearings to optimize geometry within a full system model,” said Bianco.

These are all features and capabilities that give design engineers more options to work with.

The latest KISSsoft release features a bearing design tool (fine sizing) where various parameters can be altered (eg. conformity of ring raceways, size and pitch diameter of rolling bodies and so on) and their influence on the bearing performance can be investigated.

“An additional feature is the consideration of the elasticity of the rings. Existing calculation methods always assume fully rigid rings, however modern gearbox designs feature increased power density and lower weight/dimensions, thus leading to ring elastic behavior which can’t be neglected,” said Stefan Beermann, CEO at KISSsoft.

For Schaeffler, the software tools continue to evolve and the company examines key areas that affect how their customers approach each application. “Complete system analytics of the bearings, gears, shafts, housings or plant carriers can be accounted for in many of these tools by integrating FEA-based stiffness behavior/methods into the simulations,” said Scott Hart, manager advanced development, at Schaeffler.

This “systems approach” versus focusing on a single component is the direction this industry is heading, particularly with machine to machine communication and the continuous push for digital manufacturing solutions (more on this later).

“We utilize so many programs today that our customers are learning pretty quickly that there are so many different ways these programs build on each other,” Shive said. “If they’re having a difficult time with a design they can send us the file and we can assist in the process.”

## The Industrial Internet of Things

One contributing factor to software tools is the continual push for machine to machine communication whether you call it Industry 4.0, IIoT or digital manufacturing.

The wind industry was driving remote monitoring of bearings a decade ago. The techniques used here are not different from the IIoT approach. “For the bearing software itself the influence is not very large, however, a new possible application of such software is the prediction of remaining lifetime for a bearing based on the load history as measured during service,” Beermann said.

IIoT is influencing the use of simulation tools by using the tools to analyze collected data to predict remaining life or assess potential damage that may have occurred during operation as well as determine what type of maintenance is required, according to Hart.

“At what level does the analysis occur, in the cloud based on data transferred from the machine or within the machines own data collection? This still needs to be reviewed and optimized when deciding how best to match simulation methods with available data, data transfer rates, etc.,” Hart added.

Ray knows it is important to deliver on Timken’s commitment to its customers both physically and digitally. “We are working to provide a digitized option for every customer touch point. We have e-commerce capabilities for distributors and end-user customers. Through our website and social media channels, we are reaching individual customers, end users and distributors to aid in product selection and problem solving. Now, we are converting the customer information we are gathering to better understand what products are needed and where, and what problems need to be solved,” Ray said.

At Romax, IIoT is very significant for the condition monitoring and prediction of future life for bearings. “In recent times, through our InSight brand of Internet-based sensors and monitoring systems, we have been able to detect faults and forecast the remaining useful life of wind turbine gearboxes and mainshaft bearings. This is vital for implementing optimized op-

erations and maintenance strategies as well as effective financial planning. The methods have already brought huge savings to the wind turbine industry, due to the high cost of maintenance in challenging environments,” said Bianco.

Earlier this year Romax formed InSight Analytics Solutions, a new joint venture company with Castrol to exclusively take this technology forward, scale it globally and expand to other industries. Romax will continue to work with InSight to jointly develop new areas of technology, particularly around model based prognostics and beyond current IIoT and towards the future of the “Digital Twin” (a model-based representation of the physical, ‘as manufactured’, parts which are created at time of manufacture and persist for the lifetime of that part or system).

## The Age of Mobility

In this age of instant gratification, mobile tools are helping engineers get field data quicker and more efficiently than ever. Many of the software tools and apps available today can be downloaded right to your smartphone or tablet, accessed right on an oil rig, or sent to a desktop computer for evaluation. In a sense, the computer lab of old has gone completely mobile.

“This is a quick and easy way to offer information to our customers in the field,” Shive said. “It’s better than lugging around a clunky, laptop onsite and it’s nice when the device just fits in your pocket.”

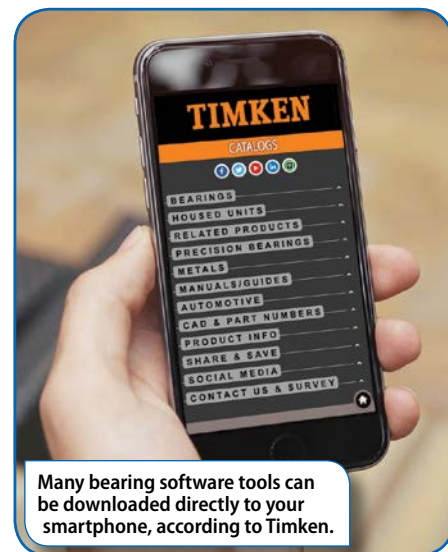

Many bearing software tools can be downloaded directly to your smartphone, according to Timken.

Mobile devices enable a level of productivity that was not easy to accomplish in the past, according to Ioannis Kaliakatsos, software development at KISSsoft. “Huge amounts of data (especially reference documentation and manuals) are easy to carry around, detailed calculations are easy to perform on-the-go, and communication with the main company intranet is easy, and thus critical decisions can be made.”

Hart said that the computing power in today’s mobile devices enables many of the initial simple simulations related to traditional fatigue life, lube life, deflections, or operating temps based on simple values of torque, load, speed and temp to be run on site in the hands of the customer. “This allows for a faster assessment of the variables considered without having to transfer large amounts of data to the cloud or wait on a large simulation to be created,” Hart added.

Romax sees the future of engineering software to be firmly in the cloud. As the industry moves towards democratization, increased integration between software tools will be necessary to allow a more streamlined process, and more efficient engineering decision making.

“The key to unlocking such a flexible, open eco-system, is to have flexible products which allow users to quickly and easily collaborate with each other. For us, this means cloud—software that is easily and conveniently accessible, fast and on any device. There are many ways in which this could materialize—cloud CAE software may offer full simulation, simply model visualization, or results’ generation and sharing,” added Bianco.

### Tomorrow’s To-Do List

So what happens next? It’s amazing to think about how much this technology has changed recently, we asked each company to give us a hint at things to come. Beermann at KISSsoft started the conversation with the gearbox:

On a gearbox level bearings are often the critical components nowadays, he said. Selecting the right bearings for a specific application needs modelling



KISSsoft’s latest release includes useful bearing data for engineers.

of the complete environment, which means the system of a relevant components such as shafts, gears and so on. On the other hand, the mechanical behavior of the bearings has a significant influence on the performance of the gears.

“So, bearing software as a stand-alone tool will vanish to a certain degree, and the calculation will be integrated into the system calculation. For efficiency and noise, the calculation methods will be improved. And if the bearing standards follow the path the gear standards were taking, more and more specialized methods will be developed for specific failure modes like pitting, micro pitting or cracks,” Beermann said.

SKF will possibly focus on consolidating its software offerings into a single package in the future, according to Shieve. “I see this potentially down the road, software tools that adapt to the changing needs of the industry by bringing all the programs together in one platform,” Shieve said.

Romax perceives that the evolution of bearing calculation software will be driven by three major factors: the changing demands of the industry and subsequent requirements to investigate novel transmissions; more powerful computing which will enable a wider audience to perform more advanced analysis; and the world’s leading innovators continuing to develop creative technology.

“As computers become more powerful, and computing devices more mobile, the need for data to be instantly accessible, anywhere, will only become greater. This could include centralized cloud databases, or apps for model visualization or analysis. Driven by the need for fast and collaborative processes, this industry development will enable more convenient collaboration and data sharing, across a range of devices,” Bianco said.

Ray agreed, “While it is hard to predict how software and technology will change, we do know our customers want more access to more information, and it needs to be easy to find and to understand. We do know our customers like materials in all forms—printed, online and interactive. We are now evaluating cloud-based applications to bring the right tools to individuals, end users and distributors,” Ray said.

“I believe that in the future more and more levels of calculation software will be incorporated from the sensor all the way to the cloud to condition/filter the data so that decisions about the life, remaining life, maintenance required/reordering new bearings can be made for a multitude of machines at just the right level for efficient management of the assets,” Hart said.

“This will most likely require computing/AI technology being incorporated into a variety of devices (sensors, data collection, data transfer),” he added. **PTE**

#### For more information:

KISSsoft USA LLC  
Phone: (815) 363-8823  
[www.kisssoft.ch](http://www.kisssoft.ch)

Romax Technology  
Phone: (248) 220-1201  
[www.romaxtech.com](http://www.romaxtech.com)

Schaeffler Group USA, Inc.  
Phone: (800) 274-5001  
[www.schaeffler.us](http://www.schaeffler.us)

SKF USA Inc.  
Phone: (267) 436-6000  
[www.skfusa.com](http://www.skfusa.com)

The Timken Company  
Phone: (877) 454-6536  
[www.timken.com](http://www.timken.com)

For Related Articles Search

bearings

at [www.powertransmission.com](http://www.powertransmission.com)



## SOFTWARE BITS

### Schaeffler

*Bearinx Online*, *Bearinx VIP*, and *Easy Friction* can be used by the customer directly to model bearing fatigue life, shaft deflections, rotor dynamic behavior, and of course frictional power loss associated with rolling element bearings including their lubrication.

Many commercially available gear analysis tools offer bearing analysis (fatigue life, deflections, approx. friction) capabilities as well, however, the detailed internal specifications for modeling a bearing are estimated unless the bearing producer shares this information or the end user designs his/her own bearing. "Also, the frictional behavior of the gears and the bearings in both new and run in conditions with consideration of the lubricant and the lubricant level/type are also approximated," Hart said. "System level structural interactions of the bearings, gears, shafts, housings or planet carriers can be accounted for in many of these analysis tools by integrating FEA based stiffness behavior / methods into the simulations."

### KISSsoft

The calculation of nonlinear stiffness and lifetime, taking the internal geometry of the bearing into account is a major feature of KISSsoft's bearing calculation, and with every release new features are added and new results are available to the designer. Earlier this year *KISSsoft 03/2017* was released with new features including evaluation of gear units on the system level, variation calculation for the inner geometry of bearings, determination of the unbalance response during the vibration calculation of shafts and more. *KISSsys* offers optimization of power density and efficiency, damage assessment, consideration of housing stiffness and more. The company offers a great deal of trainings, seminars and web demos through its website.

For Related Articles Search

software

at [www.powertransmission.com](http://www.powertransmission.com)

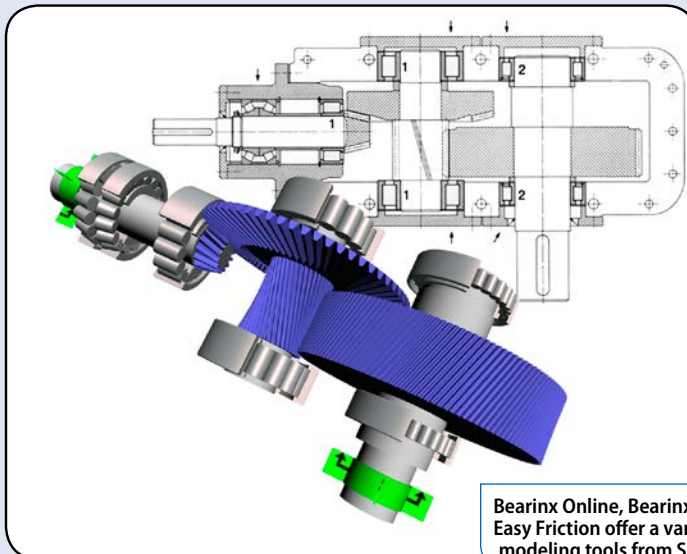

Bearinx Online, Bearinx VIP and Easy Friction offer a variety of modeling tools from Schaeffler

### Timken

Bearing knowledge is available through [www.timken.com/engineering-tools](http://www.timken.com/engineering-tools) where customers can link to bearing search, tolerances, frequencies and fatigue life calculations. This web page also covers tapered bearing assembly search, precision bearing selector, Timken catalogs and Timken bearing selection guide.

Users can start with a search of the 3D CAD and 2D drawings, reaching out for help through this site, and engaging a Timken sales engineer. "When it is a complex question, we prefer to speak directly to the customer, understand what problem needs to be solved, and then make sure the appropriate analysis tools are used to provide the most accurate answers possible," Ray said. "We use a combination of our knowledge of metallurgy, friction management and mechanical power transmission to help our customers with many of the advanced challenges they face."

### Romax

The latest version of *RomaxDesigner (R17)* includes bearing design, analysis and optimization. *RomaxWind* brings the same functionality and benefits to the wind industry and has specifically developed features to make it more suited to wind applications, such as large bearing design, analysis and optimization. *Concept* is available for fast design and analy-

sis, to enable informed design space exploration. Informed by accurate system predictions, *Concept* empowers users to make informed decisions earlier, and be confident in their selected design.

Romax's engineering team offer consultancy services on all aspects of gearbox design, analysis, optimization and root cause investigation. A core competency and part of Romax's philosophy, the team offers services including: design, advanced analysis, manufacturing and testing support, failure investigation, technical due diligence, feasibility study, trouble shooting, and metallurgy.

### SKF

*SKF Bearing Select* is a web-based bearing selection tool that calculates the rating life of rolling bearings. The calculations are based on the theories presented in the SKF Rolling bearings catalogs. *SKF SimPro Quick* is a single-shaft bearing simulation software available to customers. *SKF Shaberth* is an analytical computer program for the study of thermal performance in rolling element bearings and flexible shaft systems used in areas like aerospace. *SKF Beast* is an advanced dynamic simulation tool for rolling bearings and other mechanical systems with contacts, this proprietary software is used internally by SKF engineers to study and predict dynamic phenomena. **PTE**



**Nordex**  
INCORPORATED

Over 32,000 standard components.

Buy online 24/7.

**Nordex.com**

**Turner Uni-Drive**  
Manufacturers of Industrial Transmissions,  
Speed Reducers & Gearboxes

[www.turnerunidrive.com](http://www.turnerunidrive.com)



Catalog Multi-speed

Custom Design

OEM Manufacturing

- **Standard catalog and custom engineered gearboxes**
- **1 HP to 1000 HP**
- **Gearbox repair**
- **Reverse Engineering**

**Turner Uni-Drive** Phone: 816-931-6001 | Toll Free Phone: 800-637-7736  
3434 Terrace Street | Kansas City, MO 64111 Fax: 816-931-6055



**B&R**  
MACHINE AND GEAR CORP

**BRGEAR.COM**

## Economical Helical Speed Reducers

The Varvel RD series provide heavy duty performance in a light-weight package.



- Diecast aluminum housing
- 5 sizes 0.25 - 25 HP
- NEMA or IEC dimensions
- Unique coupling input
- Interchangeable with competitors

**DIEQUA**  
Corporation

[www.diequa.com](http://www.diequa.com)

630-980-1133

## Worm Reducers

The Varvel Worm Speed Reducer provides improved performance, high reliability and easy maintenance.



- 7 sizes, 28-110 mm CD
- Flexible coupling input
- Aluminum housings
- NEMA or IEC adapters

**DIEQUA**  
Corporation

[www.diequa.com](http://www.diequa.com)

630-980-1133

## ASK-THE-EXPERT LIVE!

**ASK the EXPERT LIVE** is coming to Gear Expo 2017 in Columbus, OH. This is your chance to have your questions answered in person by our live panel of experts.

See our expert at:  
**Gear Expo Booth #1022.**  
October 24–26

### Tuesday, October 24

- 10:30 a.m. – Cylindrical Gear Cutting: Hobbing, Shaping and Skiving
- 2:30 p.m. – Gear Design, Standards and Software

### Wednesday, October 25

- 10:30 a.m. – Gear Inspection
- 2:30 p.m. – Ask Anything

## Engineering sMart

is your resource for the latest in great ideas from our advertisers. Check this section every issue for sMart Engineering ideas and technology.

For information about advertising, contact  
Dave Friedman  
at

**(847) 437-6604**

or

*dave@powertransmission.com.*



**Can't wait?** Submit your question now!

Send it by e-mail to Senior Editor Jack McGuinn ([jmcguinn@geartechnology.com](mailto:jmcguinn@geartechnology.com)) and we'll submit it to our experts.

**Power Transmission Engineering**

[www.powertransmission.com](http://www.powertransmission.com)

**VISIT US AT BOOTH #1022**

# Gear Span Measurements

## THE QUESTION

I have been extensively searching for perfect formulas that suit designers for gear design.

Kindly recommend reference book or any source that contains all of the gear formulas.

Kindly also provide me a formula for Span measurement over teeth and DOP calculation for any gear. I am very confused to what formula really apply to the involute type of gear design.

Span measurement & DOP are widely used in gear manufacturing so please help me out.

### EXPERT RESPONSE PROVIDED BY CHUCK SCHULTZ, BEYTA GEAR SERVICES ([beytagear.com](http://beytagear.com)):

There are many reference books with the formulas you are looking for but most engineers are happy to use various on-line calculators. For gears of standard dimensions [no rack offset or "X" factor designed into the parts] the typical calculator works very well. For custom designed gears, those with non-standard dimensions, you must find a formula or calculator that allows you to enter the rack offset value.

Most gear design software packages output manufacturing and inspection dimensions such as measurement over pins or balls or a span over a specified number of teeth. It is recommended that engineers understand how to perform these calculations manually, of course, so they know what factors will influence the outcome. Once non-standard geometry becomes involved the iterative "manual" calculation becomes a real chore and confidence in the manually generated answer may be limited.

If you want a reference book that covers the topic in detail you can always count on Darle Dudley's Gear Handbook or any number of classic books. Some vendors include the formulas in their training materials that are available on-line. Gear Technology advertisers who make spline gages or cutting tools are also likely to be helpful.

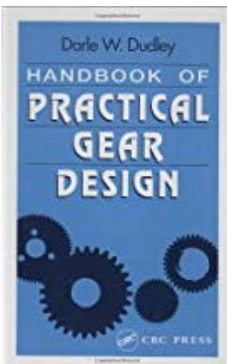

**Charles D. Schultz, PE** is Chief Engineer for Beyta Gear Service ([gearmanx52@gmail.com](mailto:gearmanx52@gmail.com)) in Winfield, Illinois, and a Technical Editor for Gear Technology and Power Transmission Engineering magazines. He is also a longtime AGMA member, having served on or chaired a number of its committees over the years. And now you can follow Chuck's new Gear Technology blog every Tuesday and Wednesday at [geartechology.com](http://geartechology.com).





# CTI Symposium China

Automotive Transmissions, HEV and EV Drives

## CTI中国论坛

汽车变速器、混合动力和电力驱动技术

25 – 27 September 2017, Shanghai | 2017年9月25–27日, 上海

### KEYNOTE SPEAKERS



**Zhengan HU**

President,  
GEELY Automobile Research Institute,  
China



**Lipeng ZHENG**

Vice President and Project Director,  
Great Wall Motor Transmission  
Research Institute,  
China



**Pu JIN**

President & CTO,  
Techrules Automobile  
R&D Co., Ltd,  
China



**Dr Minghui LIU**

Director Electric Vehicle Dept.,  
FAW R&D Center,  
China



**Dr Harald Massmann**

Head of Region Asia-Pacific,  
Powertrain Technology,  
ZF (China) Investment Co. Ltd,  
China



**Haruhisa Nakano**

Vice President,  
Jatco (Guangzhou) Automatic Transmission Ltd,  
China



**Michael Schöffmann**

Head of Transmission Development,  
Audi AG,  
Germany



**CHAIRMAN: Prof. Dr Ferit Küçükkay**

Managing Director,  
Institute of Automotive Engineering,  
Technical University of Braunschweig,  
Germany

- + More than 65 presentations
- + About 50 exhibitors
- + 570 international delegates

#### SPONSOR:



#### SPEAKERS FROM THE FOLLOWING COMPANIES:

Vorsprung durch Technik



# Baldor Motor Basics: Factors that Determine Industrial Electric Bills

Edward Cowern, P.E.

Former Baldor motors expert Edward Cowern PE, is a name known and respected by many in the electric motor industry. During his tenure at Baldor, Cowern — now enjoying his retirement — was tasked with producing a number of motor- and basics-related tutorials. The tutorials were primarily in response to a steady flow of customer questions regarding motors and applications. Today's customers continue asking questions and seeking answers to address their various motor-related concerns. We hope you find these articles useful and would appreciate any comments or thoughts you might have for future improvements, corrections or topics.

## Introduction

A good deal of confusion exists regarding the factors that determine an industrial electric bill. The following information is presented to help sort out the various items on which billing is based, and to offer suggestions on measures to help control and reduce electric utility bills.

Three basic factors and an optional item (see 4) determine an industrial power bill. They are:

1. Kilowatt hour consumption
2. Fuel charge adjustments
3. Kilowatt demand
4. Power factor penalty (if any)

**Kilowatt hours.** The first of these is the easiest to understand since it is one that we are familiar with based on our experience at home. Kilowatt hour consumption is the measure of the electrical energy that has been used during the billing period without any regard to when or how it is used. In most cases it is determined on a monthly basis by taking the accumulated kilowatt hour readings from the dial of a conventional kilowatt hour meter.

**Fuel charge adjustment.** Fuel charge adjustment is an adjustment factor determined monthly. It is based on the cost of the fuel used to produce power during a given month. For example, in areas where water power is plentiful in the spring, the contribution of water power might be great and, it is cost low. Thus, in the spring of the year, a downward adjustment might be made in fuel cost. In other instances, and at other times of the year, a utility may find it necessary to burn large quantities of high-priced imported oil to meet

their requirements. When this occurs there would be an upward adjustment of the fuel cost charge. Fuel charge adjustments are usually based on a unit charge per kilowatt hour.

**Kilowatt demand.** Perhaps the least understood factor involved in calculating an industrial electric bill is the matter of demand; demand is based on how much power is consumed during a given period of time. It is measured in kilowatts and it determines how much equipment the utility has to supply in terms of transformers, wire and generation capability, etc., to meet a customer's maximum requirements. Demand can in some ways be compared to the horsepower of an automobile engine. The normal requirement may be relatively low but the size of the engine is determined by how much power is needed to accelerate the car. Similarly, demand reflects a peak requirement. However, the term "peak" in relation to

electric demand is frequently misunderstood. In virtually all cases demand for an industrial plant is based on a 15- or 30-minute average. Thus, brief high peaks, such as those that are present during the starting of large motors, are averaged because the starting is of very short duration with respect to the demand-averaging interval.

A description of how demand is measured may help to clarify this point. In each demand meter there is a resetting timer; this timer establishes the demand interval. And that interval, as mentioned previously, may be either 15 or 30 minutes. In effect, during the demand interval the total number of revolutions made by the kilowatt hour meter disc is recorded. Thus, a high number of turns during the demand interval would indicate high demand, and a small total number of turns during the demand interval would indicate low demand.

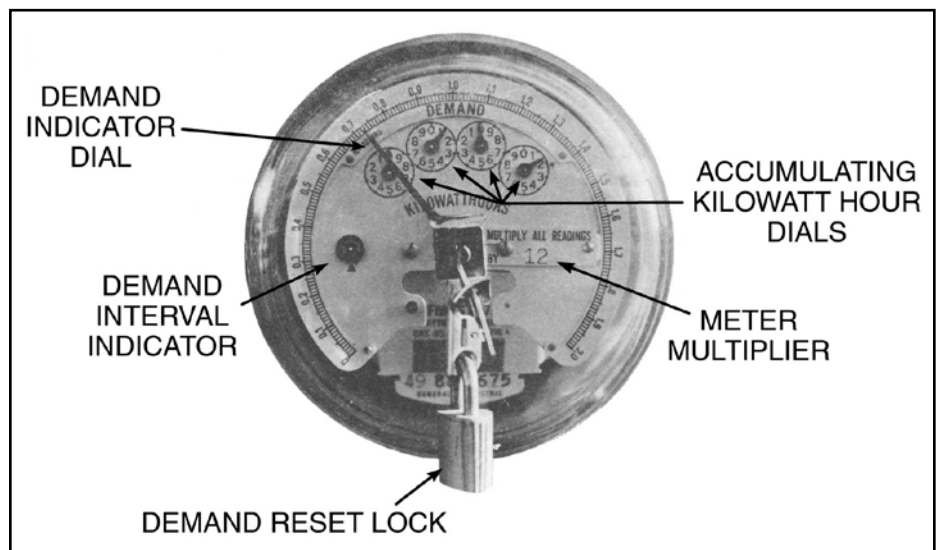

Figure 1 Example of typical demand meter used on a small commercial installation.

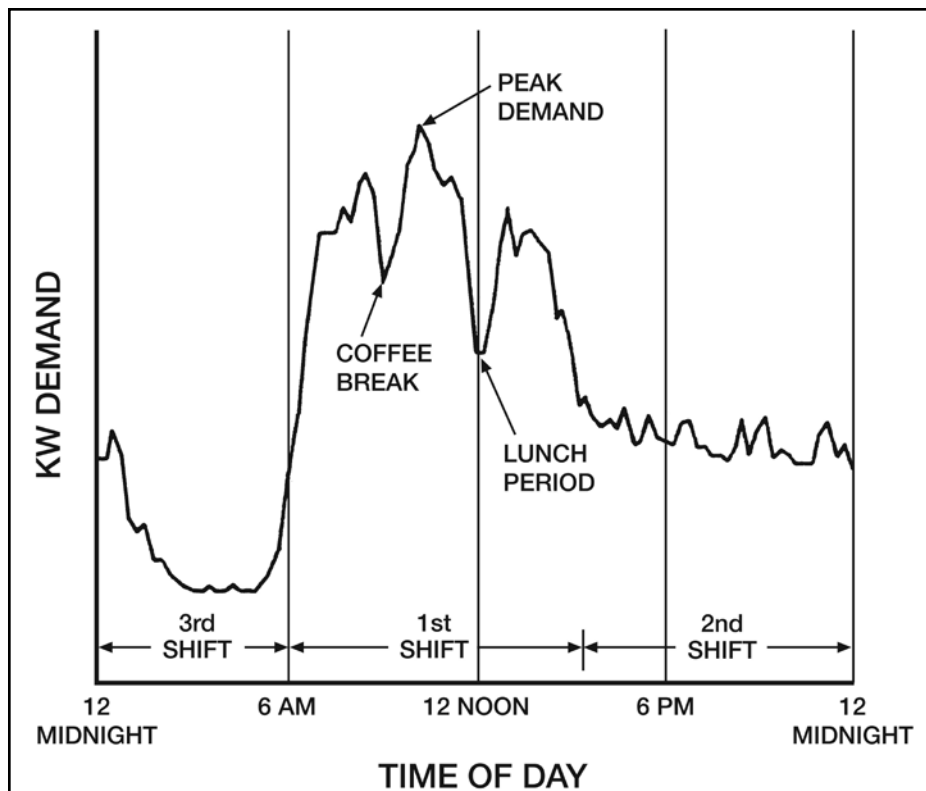

Figure 2 Example of typical manufacturing plant's recorded demand over the course of 24 hours.

For example, when a large motor is started it would cause the disc in the meter to surge forward for a short period of time. However, as the initial surge passes, the meter would settle down to a normal rotation rate. Thus, the extra disc revolutions recorded as a result of the motor in-rush would not have much impact on the total number of revolutions that accumulate during a 15- or 30-minute interval. At the end of each demand-averaging interval the meter automatically resets and starts recording for the next 15-minute period; this process goes on continuously. A special dial (Fig. 1) records only the highest demand since the last time the meter was read. When the monthly reading is taken the meter reader resets the demand to zero. Once again the meter starts searching for the highest 15-minute interval, and it does so continuously until the next time it is read. It is the highest demand for a month that is normally used to compute the bill. More about this later.

The meter shown in Figure 1 is a typical demand meter used on a small commercial installation. The demand is determined by reading the position of the top needle and multiplying that reading by the meter constant. In this

case, the reading is .725 multiplied by 12 for a demand reading of 8.7 KW. After the monthly reading is taken, the lock is unlocked, the needle reset to zero, and the meter is relocked. Accumulated kilowatt hours are recorded in the conventional manner on the dials.

Figure 2 shows an example of typical manufacturing plant's recorded demand over the course of twenty four hours. This plant had a full first shift and partial second shift. By examining the graph it is easy to pick out some of the factors influencing the demand. The initial run-up of demand occurs as the first shift starts. The growth of demand continues until the preparation for a coffee break begins. Coffee breaks result in a major dip, followed by another run-up, until the peak demand is reached shortly after 10 a.m. Demand then stays reasonably steady until preparations for lunch and the lunch period begins.

It is interesting to note that after the lunch hour, things never quite get back to equal the peak that occurred before the lunch period. Another lower peak occurs at 1:00 p.m., followed by lower peaks and a final drop-off as clean-up and end-of-shift occurs. The second shift has peaks and valleys similar to

the first shift, but shows the lower level of activity in the plant. Finally, on the third shift, demand drops sharply to a level reflecting only the very basic loads of security, lighting, and other continuous loads.

**Controlling demand.** Reducing demand peaks will result in lower demand charges and lower bills. High demand can result from a number of factors. Some of the most likely would be the heating up of large furnaces or ovens during the normal work day. This can happen since the heat-up requirement may be five to six times the sustaining requirement for this equipment. Installing time switches that will allow the unit to pre-heat to normal operating temperature before the plant shift starts is one easy way to reduce demand peaks. This approach keeps the large demand required by heat-up from being imposed on top of the normal plant demand. Large central air conditioning chillers can pose similar problems if they are allowed to start during the normal shift rather than pre-cooling the building during a non-working period.

Other factors that can contribute to high demands would be items such as air compressors if start-up is delayed until after the normal work shift starts. In this case the compressor may run at full load for an extended period, until the accumulator and distribution system has been filled. The solution with air compressors is the same as that with industrial ovens; a timer can be used to start the compressors and fill the system prior to the normal shift start. This approach allows the pressure to build up and the compressor to fall into a normal loading and unloading pattern prior to the time that the balance of the plant load is applied.

With some thought you will be able to discover some items within a facility that may fall into the category that can increase peak demand. The installation of seven-day timers that will start essential compressors, ovens and other similar loads ahead of the first shift can help reduce demand in most plants.

Demand charges are normally figured on a dollars-per-kilowatt basis. For example one Connecticut utility has an industrial power rate that charges \$401.00 for the first 100 kilowatts of

demand, and \$2.20 for each additional kilowatt.

**Demand ratchets.** To encourage industrial plants to control their demand to reasonable levels, many utilities impose a twelve-month ratchet on demand. What this means is that a very high demand, established in a particular month, will continue to be billed at a percentage of that high demand for eleven months unless actual demand exceeds the established percentage of the previous peak. This type of arrangement can be expensive to the power customers who are not careful in controlling their demand—and to industries having high, seasonal variations.

In many situations it is not possible to exercise any great degree of control over plant demand without encumbering operations unnecessarily and adding extra labor costs, etc. Even if a plant happens to be in one of these situations, it is important to understand the basic factors involved in demand and to understand what equipment within a facility is contributing to the total demand picture.

**Demand monitoring and control.** Demand monitoring and control equipment is available to help plant operators control their demand and energy costs. This equipment is based on monitoring demand build-up over the normal demand-averaging interval and taking action to curtail certain loads or operations to level peaks and prevent new peaks from being established. For demand control to be effective a plant must have electrical loads that can be deferred. Typical examples of deferrable loads would be water heating for storage, heat treating, and possibly the controlled shutdown of certain portions of ventilation systems where short-term interruptions would not create a problem.

Demand control is not for everyone but it can save substantial amounts of money when the right conditions exist.

**Power factor.** Another misunderstood item in computing industrial electrical bills is power factor penalty. Power factor, in itself, is quite complicated to attempt to deal with in a broad manner.

However, a capsule summary might be in order.

Utilities have to size their transformers and distribution equipment based on the amount of amperes that are going to be drawn by the customer. Some of these amperes are borrowed to magnetize inductive loads within the plant. This borrowed power is later returned to the utility company without having been bought. This borrowing and returning goes on at the rate of 60 times a second (the frequency of a 60-cycle power system). The borrowed power, as mentioned previously, is used to magnetize such things as electric motors, transformers, fluorescent light ballasts, and many other kinds of magnetic loads within a plant. In addition to the borrowed power there is the so-called “real power.” This is the power that is used to produce heat from heating elements, light from incandescent bulbs, and to drive the shaft on motors. Power factor is a measure of the relative amounts of borrowed versus real power that is being used within the plant.

Obviously, utilities would like to have the situation where the customer borrows nothing and utilizes everything. In commercial and industrial situations, this ideal almost never exists. Plants with large quantities of lightly loaded motors or large quantities of electric welding equipment may run at poor power factors of 65 to 70%. On the other hand, plants with substantial amounts of electric heating equipment—as found in injection molding machines and fully loaded motors—could run with power factors of 85 to 90%.

Plants with poor power factors can improve their situation by adding power factor correction capacitors to their systems. Power companies like to have plants provide power factor correction

capacitors since they lessen the number of amperes that need to be supplied. Within an individual plant, higher power factors also mean that incoming circuit-breakers and distribution panels are not being taxed as much. So, within the plant, good power factor has some rewards as well.

**Power factor penalties.** Some utilities impose power factor penalties. What this means is that when your power factor falls below a pre-established level, a penalty charge may be added to the basic bill for kilowatt hours, fuel charge, and demand. The amount of the penalty is dependent on how far below the pre-established level the power factor falls. There is no uniformity among utilities on how they determine the power factor penalties or at what level they start. The variations in the way they are imposed are almost as large as the number of different utilities in the country. The penalties can range from none at all—the case with a great many power companies—to very substantial penalties imposed by others. Frequently, when penalties are imposed there is also a reward arrangement. The reward is structured to reward high power factor customers by giving them a credit on the monthly bill for having high power factor.

If you are concerned with power factor and any possible penalty you may be paying, the best approach is to contact the local power company. They will provide you with any information you might require on the existing power factor and any penalties that are being paid. They can also help you compute the amount of power factor correction that you may need to eliminate any penalty charges.

Table 1 Simplified analysis of how various conservation and load control actions affect the four components that make up a normal industrial electric bill.				
EQUIPMENT OR ACTION	ENERGY (KW HRS)	FUEL COST ADJ.	DEMAND KW	POWER FACTOR
REDUCED LIGHT LEVELS	REDUCED	REDUCED	REDUCED	NEGLIGIBLE
MORE EFFICIENT LIGHT SOURCE	REDUCED	REDUCED	REDUCED	NEGLIGIBLE
ENERGY EFFICIENT MOTORS	REDUCED	REDUCED	REDUCED	MODEST IMPROVEMENT
PROPER SIZING OF MOTORS	MODEST REDUCTION	MODEST REDUCTION	MODEST REDUCTION	REASONABLE IMPROVEMENT
DEMAND CONTROL	SLIGHT REDUCTION	SLIGHT REDUCTION	SUBSTANTIAL REDUCTION	NEGLIGIBLE



## Summary

Understanding the four factors that go into determining industrial electric bills can help map approaches to saving money. Generally speaking, conservation efforts such as reduced lighting levels, buying more efficient motors, and replacing existing inefficient equipment with equipment having better designs, will reduce both kilowatt hour consumption and kilowatt demand. Reducing kilowatt hour consumption will also reduce fuel charge assessment. Shifting demand of certain types of equipment into more optimum time periods when plant demand is low, can reduce kilowatt demand and the charges associated with it. Finally, an improving power factor, if there are penalties being imposed, will help reduce power factor penalty charges.

A basic understanding of these four factors can help the conservation-minded to reduce overall electric energy costs. Table I shows a simplified analysis of how various conservation

and load control actions affect the four components that make up the normal industrial electric bill. It can be used as a guide in directing conservation and electric bill reduction. **PTE**

### For more information:

Baldor Electric Company/Member of the ABB Group  
5711 R. S. Boreham Jr. Street  
Fort Smith AR 72901  
Phone: (479) 648.5694 | 205694  
[www.baldor.com](http://www.baldor.com)

**Edward H. Cowern** was Baldor's New England district manager from 1977 to 1999. Prior to joining Baldor he was employed by another motor company where he gained experience with diversified motors and motor-related products. He is a graduate of the University of Massachusetts, where he obtained a BS degree in electrical engineering. He is also a registered professional engineer in the state of Connecticut, a member of the Institute of Electrical and Electronic Engineers (IEEE), and a member of the Engineering Society of Western Massachusetts. Cowern is an excellent and well-known technical writer, having been published many times in technical trade journals such as Machine Design, Design News, Power Transmission Design, Plant Engineering, Plant Services and Control Engineering. In addition, he has authored many valuable technical papers for Baldor, used repeatedly by sales and marketing personnel throughout our company. Cowern resides in North Haven, Connecticut with his wife, Irene. He can be reached at [ehcowern@snet.net](mailto:ehcowern@snet.net).

## Power Transmission Engineering online!

It's like your own professional superpower.

Stronger, faster and smarter than your average website, [www.powertransmission.com](http://www.powertransmission.com) offers everything you need to supercharge your engineering-oriented organization.

- Complete archive of articles on engineered components
- Directory of suppliers of gears, bearings, motors and other mechanical power transmission components
- Product and Industry News updated daily
- Exclusive online content in our e-mail newsletters
- The Bearings Blog
- Calendar of upcoming events
- Comprehensive search feature helps you find what you're looking for — *faster than a speeding bullet!*

[www.powertransmission.com](http://www.powertransmission.com)

# Rolling Bearing Service Life Based on Probable Cause for Removal — A Tutorial

Erwin V. Zaretsky and Emanuel V. Branzai

From the Author...

With improved manufacturing and steel processing, together with advanced lubrication technology, the potential improvements in bearing life can be as much as 80 times that attainable in the late 1950s, or as much as 400 times that attainable in 1940. Today, bearing fatigue probably accounts for less than 5% of all bearings removed from service for cause. Of ~224,000 commercial aircraft engine bearings removed from service for rework, 1,977 or 0.88% were rejected because of fatigue.

*What's new?*

A bearing service life prediction methodology and tutorial indexed to eight probable causes for bearing failure and removal are presented — including fatigue. Bearing life is probabilistic and not deterministic. Bearing manufacturers' catalogue ( $L_{10}$ ) bearing life is based on rolling-element fatigue failure, at which time 90% of a population of bearings can be reasonably expected to survive, and 10% to fail by fatigue. However, approximately 95% of all bearings are removed for cause before reaching their  $L_{10}$  life. A bearing failure can be defined as when the bearing is no longer fit for its intended purpose. For a single bearing, you can only predict the probability of a failure occurring at a designated time — but not the actual time to failure.

*We — and the author — want to know what you think about the bearing service life methodology and tutorial presented in this paper. Especially if you are manufacturing, buying or selling bearings in great quantities — and you have a question or comment regarding how this alternative methodology might affect your business — please send your questions or comments to [jmcguinn@powertransmission.com](mailto:jmcguinn@powertransmission.com).*

## Nomenclature

- $F$  = Probability of failure (fractional percentage or percentage)
- $F_n$  = Probability of failure of a chain consisting of  $n$  links (fractional percentage or percentage)
- $L$  = Life, cycles (stress cycles); inner- or outer-ring revolutions (h)
- $L_{ref}$  = Reference life, inner or outer ring revolutions (h)
- $L_{serv}$  = Bearing service life, inner- or outer-ring revolutions (h)
- $L_{\beta}$  = Characteristic life (time at which 63.2% of a population will fail, or 36.8% will survive), cycles (stress cycles), inner- or outer-ring revolutions (h)
- $L_{\mu}$  = Location parameter or time below which no fatigue failure should occur, cycles (stress cycles), inner- or outer-ring revolutions (h)
- $m$  = Slope of the Weibull plot or Weibull modulus
- $n$  = Number of independent components
- $P$  = Load (N or lbs.)
- $S$  = Probability of survival
- $X$  = Number of bearings removed from service because of fatigue divided by all bearings removed from service regardless of cause (fractional percentage)

## Introduction

In the first edition of his book, *Ball and Roller Bearing Engineering*, Dr. Arvid Palmgren (Ref. 1) defines the term (bearing) life as follows:

No bearing gives an unlimited length of service. If a ball or roller bearing is exposed to moisture or dirt, it may be rendered unserviceable due to rust (corrosion) or wear, after a period of service which obviously cannot be predicted. However, if it is effectively protected, well lubricated, and otherwise properly handled, all causes of damage are eliminated except one, the (rolling-element) fatigue of the material due to repeated

stresses under rotation. The effect of this fatigue is the so-called flaking, which starts as a crack and develops into a spalled area on one or the other of the load carrying surfaces. Fatigue is, ultimately, unavoidable but the number of revolutions the bearing may make before flaking starts is a function of the bearing load. The term "LIFE" can therefore be given a more exact definition to mean that period of performance which is limited by (rolling-element) fatigue phenomena. Life is measured in number of revolutions of the bearing or the number of hours of operation at a certain speed of rotation. Individual bearings which are apparently identical and which operate under identical conditions may, however, have different lives (p 68).

The  $L_{10}$  life, or the time that 90% of a group of bearings will exceed without failing by rolling-element fatigue, is the basis for calculating bearing life and reliability today. Accepting this criterion means that the bearing user is willing in principle to accept that 10% of a bearing group will fail before this time and 90% will survive.

The rationale for using the  $L_{10}$  life was first laid down by Palmgren in 1924 (Palmgren (Ref. 2)). He states:

The (material) constant  $C$  has been determined on the basis of a very great number of tests run under different types of loads. However, certain difficulties are involved in the determination of this constant as a result of service life demonstrated by the different configurations of the same bearing type under equal test conditions. Therefore, it is necessary to state whether an expression is desired for the minimum, (for the) maximum, or for an intermediate service life between these two extremes. In order to obtain a good, cost-effective

result, it is necessary to accept that a certain small number of bearings will have a shorter service life than the calculated lifetime, and therefore the constants must be calculated so that 90 percent of all the bearings have a service life longer than that stated in the formula. The calculation procedure must be considered entirely satisfactory from both an engineering and a business point of view, if we are to keep in mind that the mean service life is much longer than the calculated service life and that those bearings that have a shorter life actually only require repairs by replacement of the part which is damaged first (pp 5-6).

Palmgren is perhaps the first person to advocate a probabilistic approach to engineering design and reliability. Certainly, at that time, engineering practice dictated a deterministic approach to component design. This approach by Palmgren was decades ahead of its time. What he advocated is designing for finite life and reliability at an acceptable risk (Zaretsky (Ref. 3)).

By the close of the 19th century, the rolling-element bearing industry began to focus on sizing of ball and roller bearings for specific applications and determining bearing life and reliability. However, before the 1924 work of Palmgren (Ref. 2), it would appear that rolling-element bearing fatigue testing was the only way to determine or predict the minimum or average life of ball and roller bearings. In 1896, Professor Richard Stribeck (Ref. 4) in Germany began fatigue testing full-scale rolling-element bearings. In 1912, Professor John Goodman (Ref. 5) in Great Britain published formulae based on fatigue experiments that he began in 1896 to compute safe loads on ball and cylindrical roller bearings (Zaretsky (Ref. 6)).

To the best of the authors' knowledge, a database that defines and/or determines the life and reliability of rolling-element bearings at the beginning of the 20th century is not readily available. In 1914, the *American Machinists Handbook* (Colvin and Stanley (Ref. 7)) devoted six pages to rolling-element bearings that discussed bearing sizes and dimensions, recommended (maximum) loading, and specified speeds. However, the publication did not address the issue of bearing life. Nevertheless, the qualitative lives of these bearings can be inferred from Stribeck (Ref. 4), wherein Henry Hess translated Stribeck's work from German to English, which was published in the 1907 *Transactions of the American Society of Mechanical Engineers*. Thomas J. Fay (Stribeck (Ref. 4)) wrote a discussion to Hess's presentation wherein he states as follows:

The life of a ball bearing is dependent upon numerous considerations of design and upon the sizes used and the mode of application; but tests now under way in the establishment represented by the writer (Mr. Fay's affiliation is not given) indicate that trouble can be expected well within 20,000 car miles from all but the finest products, even if the load is one-half the catalogue ratings. Of course plain bearings would fail long before this under the same load conditions. But the very best of ball bearings using the most appropriate grades of steel should survive 50,000 car miles (p 464).

In his reply to Fay's discussion, Hess (Stribeck (Ref. 4))

states as follows:

Changes in design and fashion of automobiles are such as to make the amortization life certainly not over five years, so that their bearings should not require renewal inside of that time. Few cars will average 50 miles per day for 250 days per year or a total of 62,500 miles. I have in my possession bearings taken from a heavy touring car that has been roughly used in racing and hard driving; these, with a known record of 65,000 miles, show no evidence of deterioration. Other records on standard passenger steam railways are over 200,000 miles with no visible effect on the bearings (p 466).

If we can assume a 1907 automobile tire diameter of 30 in. (76.2 cm), we can calculate the number of bearing revolutions for 65,000 miles of operation. This would suggest a life approximately equal to 43,719,745 bearing outer-ring revolutions for an automotive wheel bearing application at that time. If we further assume that the average speed of a 1907 automobile was 25 mph, the life of the bearing would be approximately 2,600 h. Based on 20,000 miles of operation the bearing life would be 800 h. Accordingly, it can be reasonably assumed that in 1907, bearing lives ranged from less than 800 h to as much or greater than 2,600 h at outer-ring speeds of 280 rpm. In terms of current bearing lives, these times are relatively low.

In 1910, A.-B. Svenska Kullager-Fabriken (SKF) bearing company in Sweden began rolling-element bearing endurance testing (Styri (Ref. 8)). These bearing fatigue tests became the basis of Palmgren's 1924 published bearing life analysis (Palmgren (Ref. 2)). In 1939, W. Weibull (Refs. 9-10), also of Sweden, published his theory of failure and the Weibull distribution function. Weibull was a contemporary of Palmgren and shared the results of his work with him. In 1947, Palmgren, in concert with G. Lundberg, also of Sweden, using strict series reliability analysis, incorporated his previous work along with that of Weibull, benchmarked to pre-1940 SKF rolling-element bearing tests, to form a probabilistic analysis to calculate rolling-element (ball and roller) bearing life (Lundberg and Palmgren (Refs. 11-12)). The Lundberg-Palmgren bearing life model is the basis for all contemporary bearing life calculations (Zaretsky (Ref. 6)).

Primary components limiting the life of gas turbine engines for aircraft application in the early 1950s were the ball and roller bearings used to support the main rotor shaft. At that time, the lives of these bearings were limited to approximately 300 h in aircraft turbine engine application. With improved bearing manufacturing and steel processing together with advanced lubrication technology, the potential improvements in bearing life can be as much as 80 times that attainable in the late 1950s or as much as 400 times that attainable in 1940 (Zaretsky (Ref. 6)).

B. L. Averbach and E. N. Bamberger (Ref. 13) examined approximately 200 incidents of bearings removed from aircraft engine service for cause. "The initial damage to these bearings was produced by abrasive particles, dents, grinding scores, skidding, large carbides and corrosion pits (p 241)." There was no classical subsurface-initiated spalling of any

of the bearings reported. This would suggest that “classical rolling-element fatigue” is not a primary cause for bearing removal in aircraft turbine engine main rotor bearings. The issue becomes what the service lives of these bearings at a designated reliability are or the time at which these bearings are no longer fit for their intended application.

A review of aircraft bearing rejection criteria and causes was undertaken and reported in 1979 by J. S. Cunningham, Jr. and M. A. Morgan at the Naval Air Rework Facility, Cherry Point, North Carolina (Cunningham and Morgan (Ref.14)). Their work is unique and, to the best of our knowledge, the only data of this type reported and available in the open literature. Their data were derived “from three 80-day engineering samples taken during 1969, 1971 and 1977 (p 435). Cunningham and Morgan (Ref. 14) concluded that rolling-element bearings “tend to fail at random intervals from corrosion, contamination, wear, or handling damage long before (rolling-element) fatigue initiates a spall (p 439).” From these data it is reasonable to conclude that the bearing service life is less than the calculated bearing life. Though no operating times are associated with the respective bearings associated with these data, it is possible to qualitatively associate a time related to each failure mode relative to the bearing calculated life.

In view of the aforementioned, the objectives of the work reported herein were to determine (a) the bearing service life as a function of the bearing  $L_{10}$  (fatigue) life; (b) bearing life as a function of each probable cause for removal; and (c) from commercial aircraft engine bearing field data, the percentage of rolling-element bearings removed for rolling element fatigue.

**Statistical Method**

**Weibull distribution function.** In 1939, W. Weibull (Refs. 9–10) developed a method and an equation for statistically evaluating the fracture strength of materials based upon small population sizes. This method has been applied to analyze, determine, and predict the cumulative statistical distribution of fatigue failure or any other phenomenon or physical characteristic that manifests a statistical distribution. The dispersion in life for a group of homogeneous test specimens can be expressed by:

$$\ln \ln \frac{1}{S} = m \ln \left( \frac{L - L_{\mu}}{L_{\beta} - L_{\mu}} \right) \text{ where } L_{\mu} < L < \infty; 0 \leq S \leq 1 \tag{1}$$

Where,  $S$  is the probability of survival as a fraction ( $0 \leq S \leq 1$ );  $m$  is the slope of the Weibull plot;  $L$  is the life cycle (stress cycles);  $L_{\mu}$  is the location parameter or the time (cycles) below which no failure occurs; and  $L_{\beta}$  is the characteristic life (stress cycles). The characteristic life is that time at which 63.2% of a population will fail or 36.8% will survive (Zaetsky; Ref. 6)).

The format of Equation 1 is referred to as a three-parameter Weibull equation. For most — if not all — failure phenomena, there is a finite time period under operating conditions when no failure will occur. In other words, there is zero probability of failure, or a 100% probability of survival, for a period of time during which the probability density function is non-negative. This value is represented by the location parameter  $L_{\mu}$ . Without a significantly large database, this value is difficult to determine with reasonable engineering or statistical

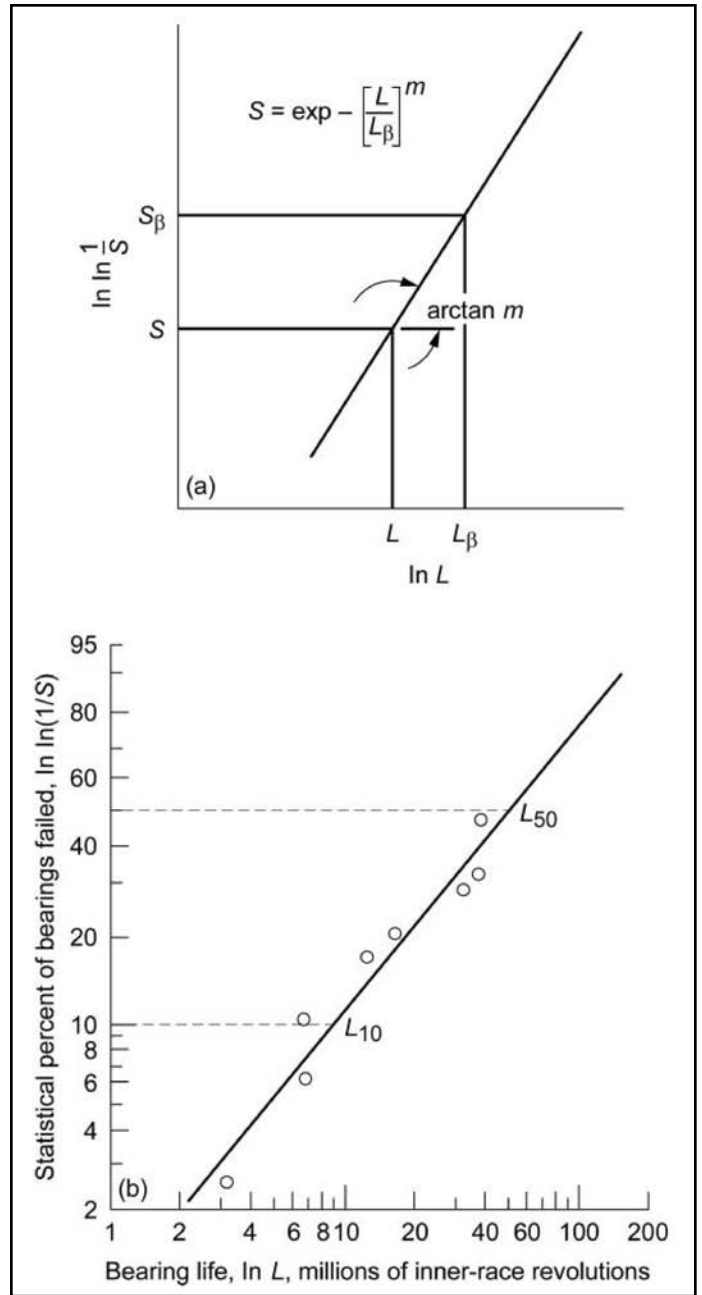

Figure 1 Weibull plot where (Weibull modulus) slope of tangent of line is  $m$ ; probability of survival  $S$  is 36.8% at which  $L = L_{\beta}$  or  $L/L_{\beta} = 1$ . (a) Schematic where  $S$  is probability of survival. (b) Rolling-element bearing fatigue data where  $\ln \ln(1/S)$  is presented in ordinate as statistical percentage of bearings failed (Zaretsky (Ref. 6)).

certainty. As a result,  $L_{\mu}$  is usually assumed to be zero and Equation 1 can be written as:

$$\ln \ln \frac{1}{S} = m \ln \left( \frac{L}{L_{\beta}} \right) \text{ where } 0 < L < \infty; 0 \leq S \leq 1 \tag{2}$$

This format is referred to as the two-parameter Weibull distribution function. The estimated values of the Weibull slope  $m$  and  $L_{\beta}$  for the two-parameter Weibull analysis will not in general be equal to those of the three-parameter analysis. As a result, for a given survivability value  $S$ , the corresponding value of life  $L$  will be similar but not necessarily the same in each analysis (Zaretsky; (Ref. 6)).

By plotting the ordinate scale as  $\ln \ln(1/S)$  and the abscissa

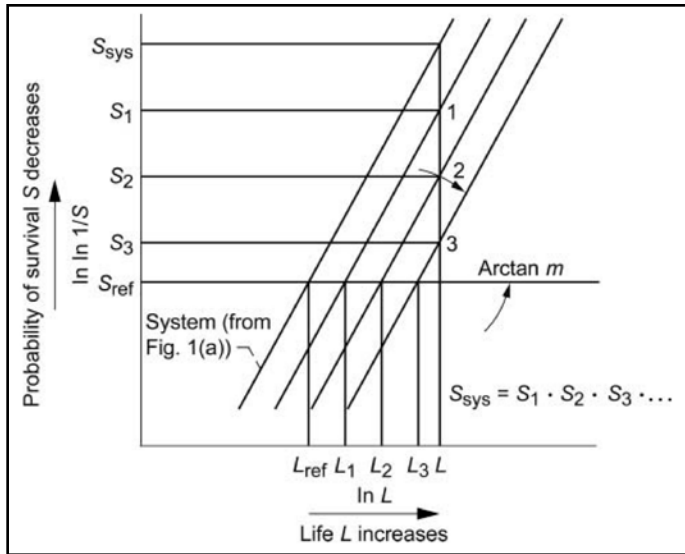

**Figure 2** Sketch of multiple Weibull plots where each numbered plot represents the cumulative distribution of each component in the system, and the system Weibull plot represents the combined distribution of plots 1, 2, 3, etc. (all plots are assumed to have the same Weibull [modulus] slope  $m$ ; (Zaretsky; Ref. 6).

scale as  $\ln L$ , a two-parameter Weibull cumulative distribution will plot as a straight line, which is called a “Weibull plot.” Usually, the ordinate is graduated in statistical percentage of specimens failed  $F$  where  $F = [(1-S) \times 100]$ . Figure 1a is a generic Weibull plot with some of the values of interest indicated. Figure 1b is a Weibull plot of actual bearing fatigue data (Zaretsky; (Ref. 6)).

L. G. Johnson (Ref. 15) developed methods for statistical data analysis utilizing the Weibull distribution function to define fatigue life population distribution.

**Strict series reliability.** If there are  $n$  independent components, each with a probability of the independent event (failure) not occurring equal to  $(1-F)$ , the probability of the event not occurring in the combined total of all components can be expressed as:

$$(1-F)^n = \exp - [nf(X)] \quad (3)$$

Equation 3 gives the appropriate mathematical expression for the principle of the weakest link in a chain or, more generally, for the size effect on failures in solids. The application of Equation 3 is illustrated by a chain consisting of several links. Testing finds the probability of failure  $F$  at any load  $X$  applied to a single link. To find the probability of failure  $F_n$  of a chain consisting of  $n$  links, one must assume that if one link has failed the whole chain fails. That is, if any single part of a component fails, the whole component has failed. Accordingly, the probability of non-failure of the chain  $(1-F_n)$ , is equal to the probability of the simultaneous non-failure of all the links. Thus,

$$1 - F_n = (1 - F)^n \quad (4a)$$

Or,

$$S_n = S^n \quad (4b)$$

Referring to Figure 2, where the probabilities of failure (or survival) of each link are not necessarily equal (i.e.,  $S_1 \neq S_2 \neq S_3 \neq \dots$ ), for the probability of survival of the chain as a system, Equation 4b can be expressed as:

$$S_{sys} = S_1 \cdot S_2 \cdot S_3 \cdot \dots \quad (4c)$$

Again referring to Figure 2, substituting appropriate values of the probability of survival  $S$  from Equation 2 into Equation 4c, where  $L_{ref}$  in Figure 2 is  $L_{serv}$  results in the following relation:

$$\left[ \frac{1}{L_{serv}} \right] = \left\{ \left[ \frac{1}{L_1} \right]^m + \left[ \frac{1}{L_2} \right]^m + \left[ \frac{1}{L_3} \right]^m + \dots \right\}^{1/m} \quad (5a)$$

$$1 = \left[ \frac{L_{serv}}{L_1} \right]^m + \left[ \frac{L_{serv}}{L_2} \right]^m + \left[ \frac{L_{serv}}{L_3} \right]^m + \dots \quad (5b)$$

Where,

$$X_1 = \left[ \frac{L_{serv}}{L_1} \right]^m \quad (5c)$$

$$X_2 = \left[ \frac{L_{serv}}{L_2} \right]^m$$

$$X_3 = \left[ \frac{L_{serv}}{L_3} \right]^m$$

**Table 1** Virtual rolling-element bearing fatigue database for generic angular-contact ball bearing subject to Weibull statistical analysis (Vleck, et al; Ref. 17).

No.	Time to failure (h)	Component failed	No.	Time to failure (h)	Component failed	No.	Time to failure (h)	Component failed
1	262	IR	21	2.933	IR	41	6.287	OR
2	476	IR	22	3.053	RE	42	6.564	IR
3	652	IR	23	3.181	IR	43	6.870	RE
4	803	RE	24	3.311	OR	44	7.211	IR
5	950	IR	25	3.444	RE	45	7.600	IR
6	1.090	OR	26	3.579	IR	46	8.053	OR
7	1.224	IR	27	3.717	RE	47	8.604	RE
8	1.354	IR	28	3.858	IR	48	9.316	RE
9	1.488	IR	29	4.003	OR	49	10.347	RE
10	1.600	OR	30	4.153	RE	50	12.408	OR
11	1.723	IR	31	4.306	IR			
12	1.845	RE	32	4.466	IR			
13	1.966	IR	33	4.630	RE			
14	2.086	RE	34	4.802	IR			
15	2.206	OR	35	4.981	OR			
16	2.321	RE	36	5.168	IR			
17	2.442	IR	37	5.368	IR			
18	2.563	RE	38	5.573	RE			
19	2.685	IR	39	5.795	IR			
20	2.809	OR	40	6.031	IR			

\*IR=inner ring; number of inner-ring failures, 25. RE=rolling-element (ball); number of ball failures, 15. OR=outer ring; number of outer-ring failures, 10.

The fractional percentage  $X$  is related to each component that has failed in the system for a specific service life and reliability and assumes that the Weibull modulus,  $m$ , is the same for each component.

Unfortunately Equation 5 is only an approximation because the system Weibull modulus  $m$  can vary with sample size, operating conditions, and failure mode. In a balanced component life system, the system Weibull modulus,  $m$ , will be somewhere between the highest and the lowest of the components' Weibull slopes. A form of this equation can be solved numerically for system reliability as a function of life and plotted on Weibull coordinates (Savage, et al. (Ref.16)). The resulting graph can be fitted with a best-fit straight line to determine the system Weibull slope and the system  $L_{10}$  life. In the event of an unbalanced life system, the lowest lived component will dominate the system failures and, thus, can serve as a good approximation for the system Weibull properties. However, at a given reliability the system life will always be lower than the lowest lived component because other components can also fail.

**Application of strict series reliability to bearing fatigue.**

Table 2 Summary of life analysis for virtual rolling-element fatigue data for generic angular-contact ball bearing.	Life (h)		Weibull modulus, $m$
	$L_{10}$	$L_{50}$	
Weibull analysis (data from Fig.3)			
Total bearings	999'	3,526	1.49
Inner ring	1,226	5,418	1.27
Rolling-elements	2,517	7,305	1.77
Outer ring	2,981	9,077	1.69
Strict series reliability (analysis benchmarked to Fig. 3a)			
Total bearings	999*	3,526	1.49
Inner ring	1,591	5,633	1.49
Rolling-elements	2,241	7,935	1.49
Outer ring	2,942	10,416	1.49
Strict series reliability (analysis benchmarked to Fig. 3d)			
Total bearings	1,150	3,503	1.69
Inner ring	1,733	5,279	1.69
Rolling-elements	2,345	7,143	1.69
Outer ring	2,981*	9,077	1.69

\*Analysis benchmarked to component  $L_{10}$  life and Weibull modulus  $m$ .

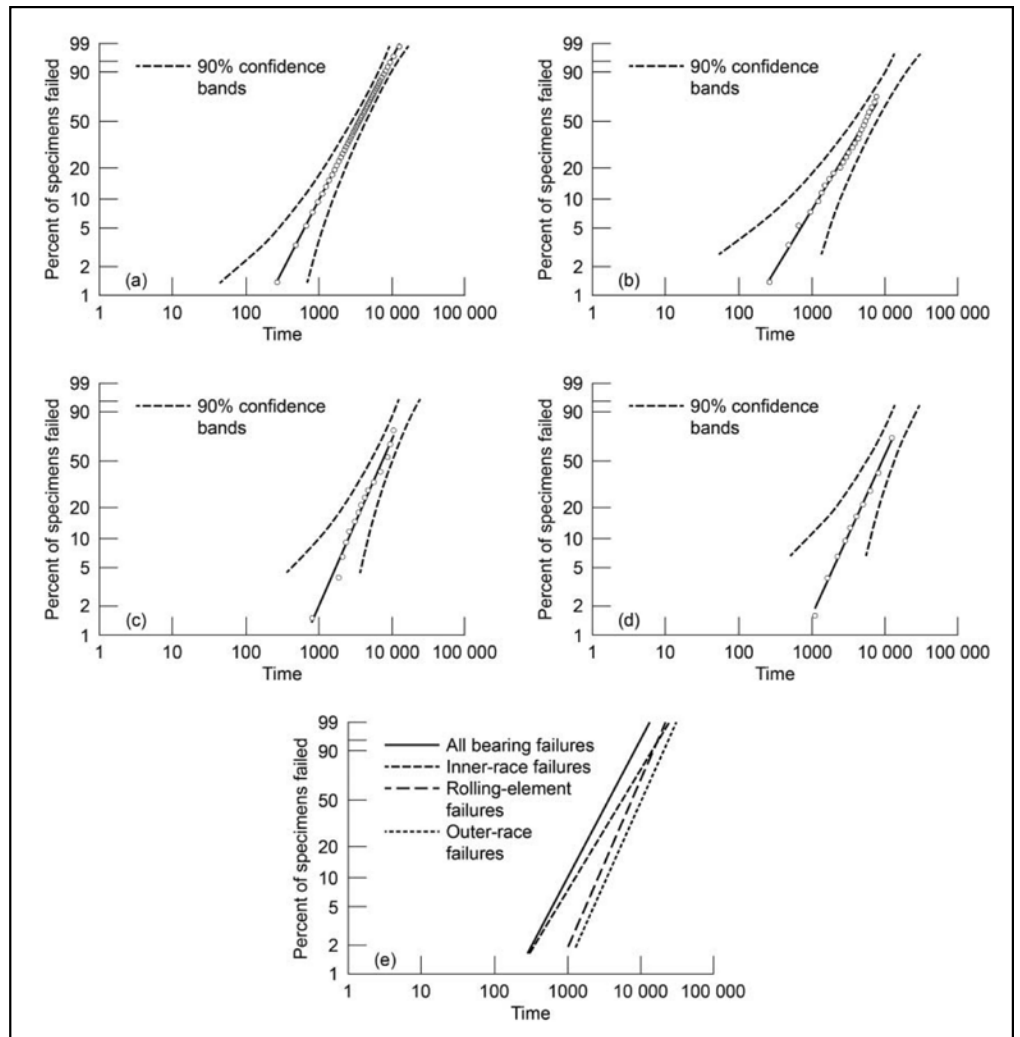

Figure 3 Failure distribution of generic angular-contact ball bearings, virtually tested under pure thrust band. (a) All bearing component failures, failure index 50 out of 50. (b) Inner race failures, failure index 25 out of 50. (c) Rolling-element failures, failure index 15 out of 50. (d) Outer race failures, failure index 10 out of 50. (e) Summary.

Assume, based on the work of Vlcek et al. (Ref. 17), that a population of 50 generic angular-contact ball bearings is virtually tested under pure thrust load. It is further assumed that the failure mode for these bearings is classical subsurface rolling-element fatigue. Their failure times and the respective component, inner ring (IR), ball (B), or outer ring (OR), that failed in each bearing are summarized in Table 1. For the purpose of this example, the failure of each component in the bearing is considered the failure time of the entire bearing; these data were analyzed using the method of L. G. Johnson (Ref. 15). The 90% confidence bands are shown with respect to these data. This would mean that in 90% of all possible cases, it can be expected, with reasonable statistical certainty, that the failure data points and thus the failure population distribution will fall between these confidence bands. The results are shown in the Weibull plot of Figure 3a and are summarized in Table 2.

In order to determine the lives of each of these respective components in the system, the failure times for a specific component being analyzed are considered a failure, and the failure times for the other components are considered to be non-failures or suspensions. These components are consid-

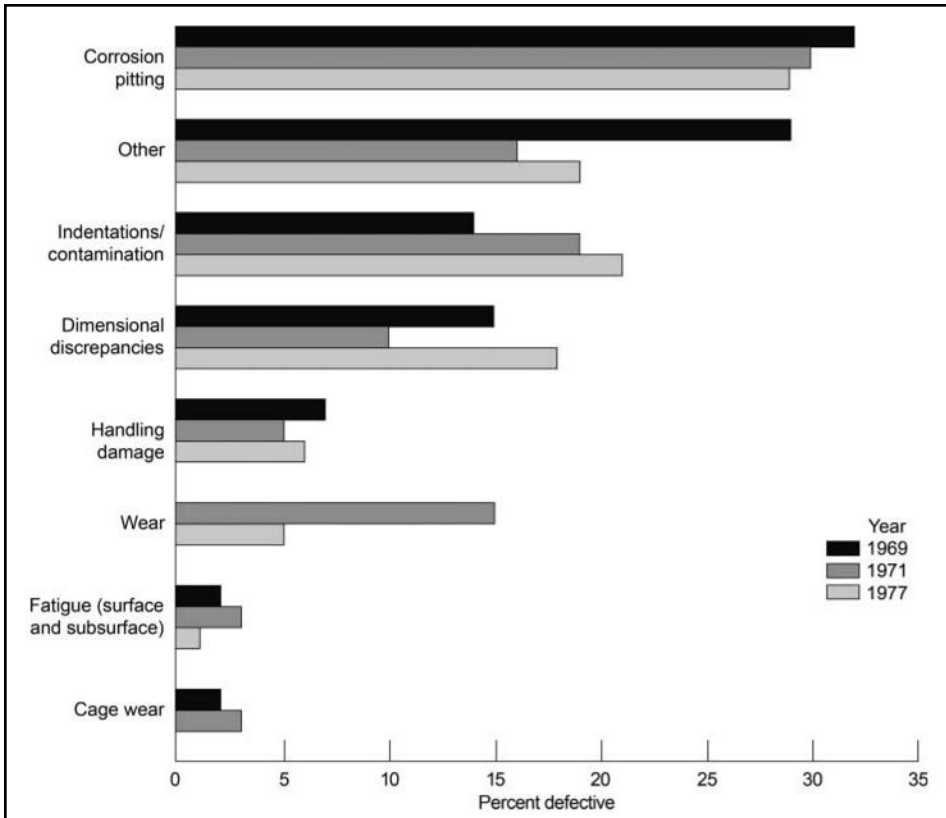

Figure 4 Naval Air Rework facility rolling-element bearing data for bearings removed from service for cause for three 80-day periods during 1969, 1971, and 1977 (data from Cunningham and Morgan; Ref. 14).

ered suspensions because the bearing would have continued to operate for an unknown time if they had not been removed from test when they failed. Again, using the method of Johnson (Ref. 15), the Weibull plots for the inner ring, balls, and outer ring are shown in Figures 3b to 3d, respectively. The  $L_{10}$  and  $L_{50}$  lives and the Weibull modulus  $m$  are summarized in Table 2 under the column designated “Weibull analysis.” The life and reliability of the system cannot exceed the life and reliability of the lowest lived component in the system — whether it is the inner ring, ball, or outer ring.

For purpose of example, assume that the data of Table 1 were available without designating the failed component in each bearing. However, the percentage of the failures representing the inner ring, balls, and outer ring is known. Using strict series reliability from Equation 5c and the data from Figure 3a, the  $L_{10}$  lives of the inner ring, balls, and outer ring are calculated. The  $L_{50}$  lives are calculated using Equation 2; the  $L_{10}$  and  $L_{50}$  lives and the Weibull modulus  $m$  are summarized in Table 2 under the “Strict series reliability” benchmarked to the total bearing  $L_{10}$  life and Weibull modulus of 1.49. These values fall within the 90% confidence bands of Figure 3.

Another example: if it is assumed that the only data that are available are those shown in Figure 3d for the outer race and the percentage of the failed population that it represents, it is possible to use strict series reliability to calculate the lives of the entire bearing using Equation 5c. The  $L_{50}$  lives are calculated using Equation 2. The  $L_{10}$  and  $L_{50}$  lives and the Weibull modulus  $m$  are summarized in Table 2 under the “Strict series reliability” benchmarked to the total bearing  $L_{10}$  life and Weibull modulus of 1.69. These values fall within the 90%

confidence bands of Figure 3.

We define *bearing failure* as the time at which the bearing is no longer fit for its intended purpose — even though the bearing is still functioning. This would be considered a cause for removal. In the above examples, if it is assumed that each of the components that failed represents a different failure mode instead of the specific component, it is possible to use Weibull statistical analysis and/or strict series reliability to determine the service life of the entire bearing set and/or the resulting life at a given reliability (probability of failure) for each failure mode represented with reasonable engineering and statistical certainty.

## Results and Discussion

**Naval Air Rework Facility rolling-element bearing data.** J. S. Cunningham, Jr. and M. A. Morgan of the Naval Air Rework Facility, Cherry Point, North Carolina (Cunningham and Morgan (Ref. 14)) published data for rolling-element bearings removed from service for cause for three 80-

day periods during 1969, 1971, and 1977. These data were presented by Cunningham and Morgan at the 33rd meeting of the ASLE (now STLE) in Dearborn, Michigan, April 17–20, 1978, and published a year later in Cunningham and Morgan (Ref. 14).

In the Introduction to their paper, Cunningham and Morgan (Ref. 14) state:

Extensive time and effort has been devoted to calculation of (rolling-element) bearing ( $L_{10}$ ) life, to determination of cage instability and to studies of the effects of various lubricants and protective coatings. However, the researcher is often at a loss for documented data on bearing rejections in a “real world” environment. This information is essential to determine those areas of developmental work that will produce the most significant increases in actual bearing (service) life and reliability. A bearing with a design life of 5,000 hours is of little value if its operational environment contributes to excessive corrosion pitting at 500 hours (p 435).”

The data of Cunningham and Morgan (Ref. 14) are summarized (Fig. 4). They categorize the probable causes of failure as 1) fatigue (surface and subsurface origin); 2) cage wear; 3) wear; 4) handling damage; 5) dimensional discrepancies; 6) debris denting and contamination; 7) corrosion pitting; and 8) other (common failure modes). From Zaretsky (Ref. 18), the other common failure modes include 1) misalignment; 2) true and false brinelling; 3) excessive thrust; 4) heat and

thermal preload; 5) roller edge stress; 6) cage fracture; 7) element or ring fracture; 8) skidding; and 9) electric arc discharge. In all, there are 16 probable causes for bearing failure and/or removal wherein the bearing is no longer fit for its intended purpose but can still be operational. Good engineering and maintenance practice would suggest that these bearings be removed from service when the determination is made that they are no longer fit for their intended purpose. It is probable that if these data were taken today, the categories outlined above and/or their related percentages would be different. Unfortunately, individual rolling-element bearing types and related times to removal are not provided for these data. Other data of this type, if it exists, are not provided in the open literature.

Cunningham and Morgan (14) observe that:

Bearing failures due to spalling are rare and almost insignificant to the overall rejection rate. Furthermore, examination of the overall rejection rate under this category revealed corrosion to be a possible cause of spall origin. Classical fatigue seems to play a very minor role in bearing reliability problems. In most cases, bearing failures are random and do not display a defined time relationship. As a result, many non-safety components are allowed to continue in service as long as they function properly (p 437).

However, using the Cunningham and Morgan (Ref. 14) database, it is possible — using Weibull statistical analysis and strict series reliability — to determine the bearing service life as a function of the bearing  $L_{10}$  (fatigue) life and bearing life as a function of each probable cause for removal. It should be noted that rolling-element fatigue, whether of surface or subsurface origin, accounts for 3% or less of the bearings removed from service for cause. That is, they were unfit for their intended purpose at the time of removal.

In order to determine and/or assign a qualitative life and resultant life factor from Figure 4, Table 3 lists probable causes for removal given to a hypothetical bearing having a design ( $L_{10}$ ) life of 5,000h, as per the example above from Cunningham and Morgan (Ref. 14).

From Equation 5c for fatigue as the failure origin where  $X=0.03$ ,  $L_{10}=5,000$  h, and  $m=1.1$ ,

$$X = \left[ \frac{L_{serv}}{L_{10}} \right]^m = \left[ \frac{L_{serv}}{5000} \right]^{1.1} = 0.03 \quad (6a)$$

$$L_{serv} = 206 \text{ h.} \quad (6b)$$

If we apply Equation 5c for corro-

**Table 3** Assumed probable causes for bearing removal, their related percentage as a function of bearings that have failed, and related  $L_{10}$  life based on a bearing service life at a 90% reliability where  $L_{serv}=206$  h. Assumed bearing  $L_{10}$  (fatigue) life = 5,000 h\*

Cause for removal	Percentage of bearings failed related to cause for removal	Calculated $L_{10}$ life (h)
Fatigue (surface and subsurface origin)	3	5,000
Cage wear	3	5,000
Wear	6	2,659
Handling damage	7	2,311
Dimensional discrepancies	17	1,031
Debris denting and contamination	20	890
Corrosion pitting	27	677
Other	17	1,031

\*Weibull modulus  $m$  was assumed equal to 1.1 for all causes of removal.

sion as a cause for removal where  $X=0.27$ ,  $L_{serv}=206$  h, and  $m=1.1$ ,

$$X_1 = \left[ \frac{L_{serv}}{L_{10}} \right]^m = \left[ \frac{206}{L_{10,c}} \right]^{1.1} = 0.27 \quad (7a)$$

$$L_{10,c} = 677 \text{ h.} \quad (7b)$$

For purposes of discussion, if we had selected a Weibull modulus  $m=1.5$  in Equation 7a, the resultant bearing life,  $L_{10,c}$ , based on corrosion would be 493 h.

Using a bearing service life  $L_{serv}=206$  h from Equation 6 and a Weibull modulus  $m=1.1$ , the  $L_{10}$  lives were calculated for each cause for removal. These values are given in Table 3 and the respective Weibull plots are shown (Fig. 5). As previously discussed, this analysis is benchmarked to the assumed bearing  $L_{10}$  fatigue life of 5,000 h.

Figure 6 shows the percentage of bearings removed from service for cause based on the calculated service life but benchmarked to the bearing  $L_{10}$  fatigue life of 5,000 h. This analysis shows that the percentage of bearings in service

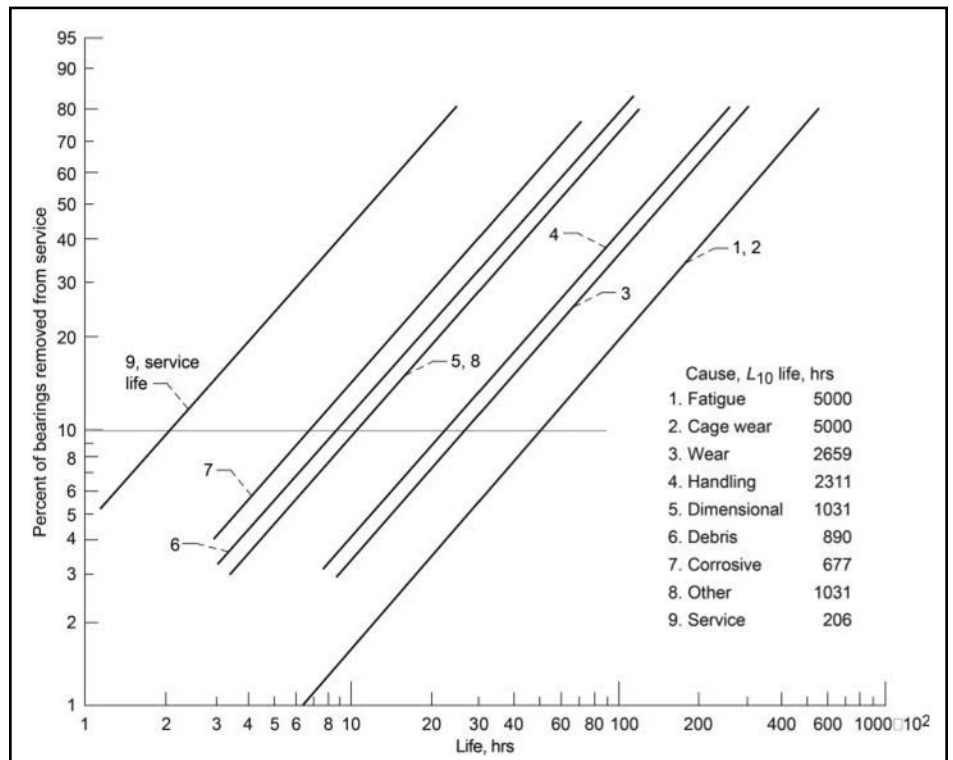

**Figure 5** Rolling bearing service life and life distribution based upon cause for removal where the calculated  $L_{10}$  bearing life is based on rolling-element fatigue equal to 5,000 h.



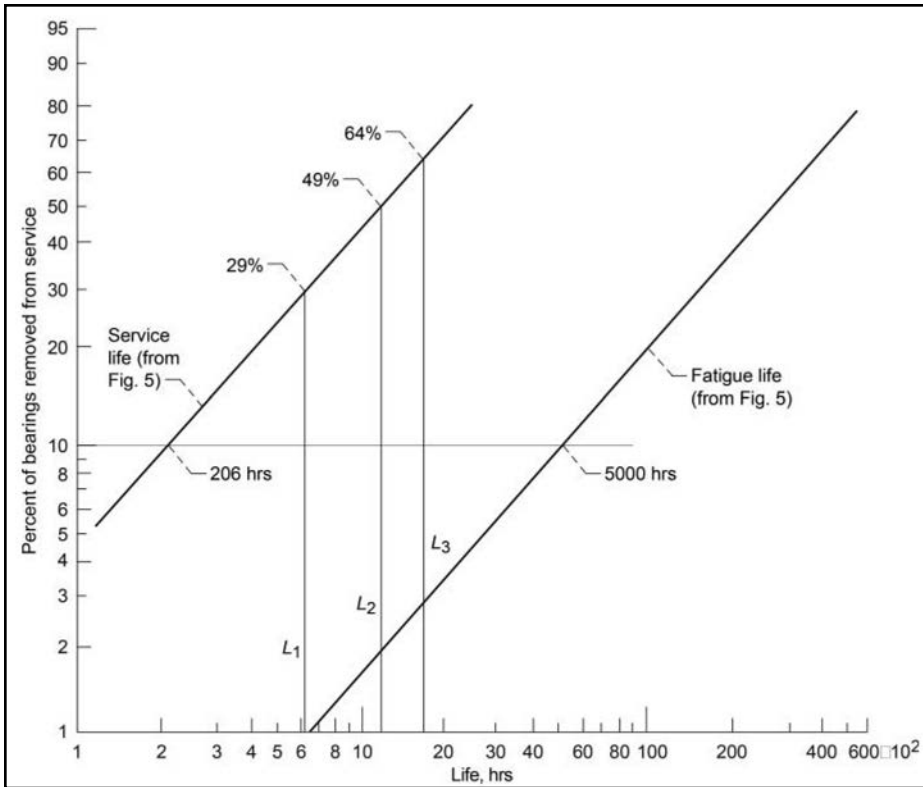

Figure 6 Percentage of bearings removed from service for cause as being unfit for their intended purpose, based on the calculated service life but benchmarked to the bearing  $L_{10}$  fatigue life of 5,000 h.

would be removed as being unfit for their intended purpose as follows:

1. At approximately 591 h, or the bearing  $L_1$  fatigue life (12% of the  $L_{10}$  fatigue life), 29% of the bearings would be removed from service.
2. At approximately 1,114 h, or the bearing  $L_2$  fatigue life or (22% of the  $L_{10}$  fatigue life), 49% of bearings would be removed from service.
3. At approximately 1,618 h, or the bearing  $L_3$  fatigue life or (32% of the  $L_{10}$  fatigue life), 64% of bearings would be removed from service.
4. At 5,000 h, or the bearing  $L_{10}$  fatigue life, 97% of the bearings would be removed from service.

The above analysis would suggest that the anecdotal perception that most bearings are removed from service before reaching their  $L_{10}$  fatigue or catalog life has merit.

An issue remains regarding this analysis. What would the service life of the bearing be if fatigue (both surface and subsurface) were to be eliminated as a failure mode? Using Equation 5a and the  $L_{10}$  lives for each mode of failure from Table 3, and eliminating fatigue as a failure mode for this calculation, the bearing service life  $L_{serv}$  increases from 206 to 212 h. This would suggest that by eliminating rolling-element fatigue as a cause for removal, the service life of these bearings would be increased by 3%.

In Table 3 we assume the Weibull modulus  $m=1.1$  and is a constant for all failure modes. As we previously discussed under Strict Series Reliability, Equation 5a is only an approximation because the system Weibull modulus  $m$  is a variable based on failure mode and is not necessarily a constant, as assumed for the above analysis. In a balanced component

life system, the service life modulus  $m$  is somewhere between the highest and the lowest of the Weibull modulus  $m$  for each of the failure modes. Hence, if we knew the Weibull modulus  $m$  for each failure mode, the life analysis could be solved numerically for system reliability as a function of life, and plotted on Weibull coordinates (Savage, et al. (Ref. 16)). The resulting graph can be fitted with a best-fit straight line to determine the system Weibull slope and the service life at a 90% reliability or a service  $L_{10}$  life.

In the event of an unbalanced life system, the lowest lived failure mode will generally dominate bearing failures and, thus, can serve as a good approximation for the system Weibull properties. From Table 3, "Corrosion pitting" is the lowest-lived failure mode. However, at a given reliability the service life will always be lower than that caused by the lowest-lived failure mode because other failure modes can also result in bearing removal.

#### Commercial aircraft turbine engine bearings.

As previously discussed, Averbach and Bamberger (Ref. 13) examined approximately 200 incidents of bearings removed from aircraft engine service for cause. "The initial damage to these bearings was produced by abrasive particles, dents, grinding scores, skidding, large carbides and corrosion pits" (p241). There was no classical subsurface- or surface-initiated spalling of any of the bearings reported. As with the work of Cunningham and Morgan (Ref. 14), this would suggest that classical rolling-element fatigue is not a primary cause for bearing removal in aircraft turbine engine main rotor bearings. The issue becomes what the service lives of these bearings are at a designated reliability or the time at which these bearings are no longer fit for their intended application.

For several decades it has been the practice of most, if not all, airlines to rework their engine rolling-element bearings when their engines are sent for refurbishment or rework (overhaul) and the bearings are removed from service. In general, most first-run commercial aircraft engines are removed from service between 15,000 and 20,000 h of operation. The rolling-element bearings are removed from the engine and are subjected to Level I or Level II rework (Zaretsky and Branzai (Ref. 19)). According to Zaretsky and Branzai (Ref. 19), Level I repair is a reclamation of the bearings that involves inspecting a used bearing and checking and comparing it with new bearing data or reverse-engineering data requirements. Other Level I processes include, but are not limited to, demagnetization, cleaning, nondestructive testing, visual/microscopic inspection, and minor repairs. At Level I inspections the bearing can be rejected for cause as being no longer fit for its intended purpose. For each Level I

repair the resulting bearing life is reduced from that of a new or unused bearing.

For those bearings that require repair beyond that of the Level I and are discarded for cause, the Level II repair is used, which encompasses all of the operations of Level I plus one or more of the following (Zaretsky and Branzai (Ref. 19)):

1. Replacing rolling-elements (with new ones)
2. Rework or replacing retainers (cages)
3. Interchanging used components and/or substituting new components to create a different assembly identity
4. Grinding or polishing and/or plating mounting surfaces as necessary to return to original drawing dimensions
5. Honing (superfinishing) raceways (to the maximum oversized rolling-element allowed)

Zaretsky and Branzai (Ref. 20) established a simple algebraic relationship to determine the  $L_{10}$  rolling bearing fatigue life of bearings subject to rework. Depending on the extent of the repair, and based on theoretical analysis, representative life factors (LFs) for bearings subject to repair that ranged from 0.87 to 0.99 the lives of new bearings. According to Zaretsky and Branzai (Ref. 20), the potential cost savings from bearing rework varies from 53 to 82% that of new bearings, depending on the cost, size, and complexity of the bearing.

Timken Aerospace Bearing Repair, Los Alamitos, California (formerly Bearing Inspection, Inc.) furnished us with their rolling-element bearing repair (rework) history for the period January 2007 through December 2013. These data included

approximately 224,000 aircraft engine ball and roller bearings repaired that included the data for two aircraft engine types designated by us as Engine Type Series A and Engine Type Series B. In general these bearings are manufactured from vacuum arc re-melted and/or vacuum induction melt-ed-vacuum arc re-melted AISI 52100 and AISI M-50 bearing steels. In addition, these bearings operate, for the most part, under a lubricant film parameter 1.5 with lubricant (oil) filtration  $\beta_{s(c)} \leq 10$ . These data are summarized in Table 4; unfortunately, it is not categorized by bearing type and size, engine main shaft position, or cause for rejection, except for fatigue. Of the 224,000 bearings reported in Table 4A, 1,977 bearings or ~0.88% (<1%) were rejected for fatigue. The specific bearing component of these 1,977 that failed from fatigue is identified in Table 4B. Unfortunately, the percentage or number of bearings removed from service for reasons other than fatigue were not available.

Though we do not have information and/or data that would allow us to segregate the bearings by type, application, and/or time, it can be reasonably assumed that the main shafts of the two aircraft engines represented in Table 4, from which the bearings were removed, had a set of seven rolling-element bearings each — two each angular-contact ball bearings and five each cylindrical roller bearings. From strict series reliability (Eqs. 4 and 5), the bearing system life calculated will be less than the lowest lived bearing in the assembly. This is assumed to be the engine main shaft angular-contact ball

**Table 4 Commercial aircraft engine rolling-element bearing rework history, from January 2007 thru December 2007\***

<b>A. Number of bearings rejected for fatigue for all engine bearings</b>				
Engine type	Total number of bearings received~224,000	Total number of bearings rejected Unknown	Number of bearings rejected for fatigue 1,977 out of ~224,000	Fatigue rejection ratio (%) 0.88
All series				
<b>B. Bearings rejected for fatigue per bearing component for all engine bearings</b>				
Engine type	Bearing component	Number of bearings rejected for fatigue		Fatigue rejection
All series	Undesignated	107		0.05
	Rolling-elements	533		0.24
	Inner ring	791		0.35
	Outer ring	546		0.24
	Total	1,977 out of 224,000		0.88
<b>C. Bearings removed from engine designation A</b>				
Engine type	Total number of bearings received	Number of bearings rejected for all reasons	Rejection ratio for all reasons (%)	
Series A	24,471 out of ~224,000	5,049	20.6	
<b>D. Bearings removed from engine designation A</b>				
Engine type	Total number of bearings received	Number of bearings rejected for all reasons	Rejection ratio for all reasons (%)	
Series A1	9,184 out of 24,471	1,613	17.6	
<b>E. Bearings rejected for fatigue per bearing component from engine designation A</b>				
Engine type	Bearing component	Number of bearings rejected for fatigue		Fatigue rejection ratio (%)
Series A1	Undesignated	0		0
	Rolling-elements	0		0
	Inner ring	3		~0.04
	Outer ring	14		~0.15
	Total	17 out of 9,184		~0.19
<b>F. Bearings removed from engine designation B</b>				
Engine type	Total number of bearings received	Number of bearings rejected for all reasons	Rejection ratio for all reasons (%)	
Series B	1,525 out of 224,000	252	16.5	
<b>G. Bearings rejected for fatigue per bearing component from engine designation B</b>				
Engine type	Bearing component	Number of bearings rejected for fatigue		Fatigue rejection ratio (%)
Series B	Undesignated	0		0
	Rolling-elements	0		0
	Inner ring	6		~0.04
	Outer ring	1		~0.01
	Total	7 out of 1,525		~0.05

\*Courtesy of Timken Aerospace Bearing Repair, Los Alamitos, California.

thrust bearing. It is further assumed that all bearings were removed from service on or before 20,000 engine operating hours.

Referring to Table 4C, of the 224,000 bearings reported in Table 4A, there were a total of 24,471 bearings removed for rework and inspected from what we designate as Engine Type Series A. Of this number 5,049—or 20.6%—were rejected for cause. The data does not report the number of bearings comprising the 5,049 that had failed from fatigue. However, a sub-set of these data comprising 9,184 of the 24,471 bearings that we have designated as Engine Type Series A bearings are summarized in Tables 4D and 4E. From this group, out of the 1,613 bearings rejected for all causes, 17 individual bearings—or ~0.19%—were removed for fatigue.

Tables 4F and 4G contain bearing data for a different engine that we designate as Engine Type Series B. This data set includes 1,525 bearings, of which 252—or ~16.5%—were rejected for cause. Of the 252 bearings rejected for cause, 7—or ~2.8% of the bearings removed for cause—were rejected for fatigue.

Based upon the above discussion, for purposes of analysis it was assumed that all bearings were removed from service on or before 20,000 engine operating hours. Further, based on Table 4C it can be assumed that ~21% of all bearings were removed from service for cause. In addition, based on Table 4A, 1% of all bearings removed for rework failed from fatigue. This would imply for purposes of analysis that of all of the bearings that were removed for cause—approximately 5%  $\{[0.01(224,000) \div 0.21(224,000)] \times 100 = 4.76\%$ —were for rolling-element fatigue.

Referring to the Weibull plot in Figure 7, a 21% service life ( $L_{21}$ ) is shown. For fatigue failures it can be reasonably assumed for purposes of calculation that the Weibull modulus (slope) is equal to 1.1. Using Equation 5c and a Weibull modulus of 1.1, the  $L_{21}$  fatigue life is calculated to be 318,570 h (Step 1). From the Weibull distribution function—Equation 2—the bearings'  $L_{10}$  fatigue lives equal 153,206 h (Step 2).

Again, referring to the Weibull plot (Fig. 7), a 21% service life ( $L_{21}$ ) is shown together with an assumed Weibull modulus  $m=1.1$ . We do not have data to determine the distribution (Weibull modulus  $m$ ) for the population of bearings removed from service for all causes. However, we can reasonably assume, for purposes of engineering analysis, that the statistical distribution of the bearings that are removed from service for all causes can vary between the exponential distribution (Weibull modulus  $m=1$ ), the Raleigh distribution (Weibull modulus  $m=2$ ), and the normal or Gaussian distribution (Weibull modulus  $m=3.57$ ). From the Weibull distribution function (Eq. 2), the calculated  $L_{10}$  service lives equal 9,618, 13,517, and 15,985 or 6.3, 8.7, and 10.4% of the  $L_{10}$  fatigue

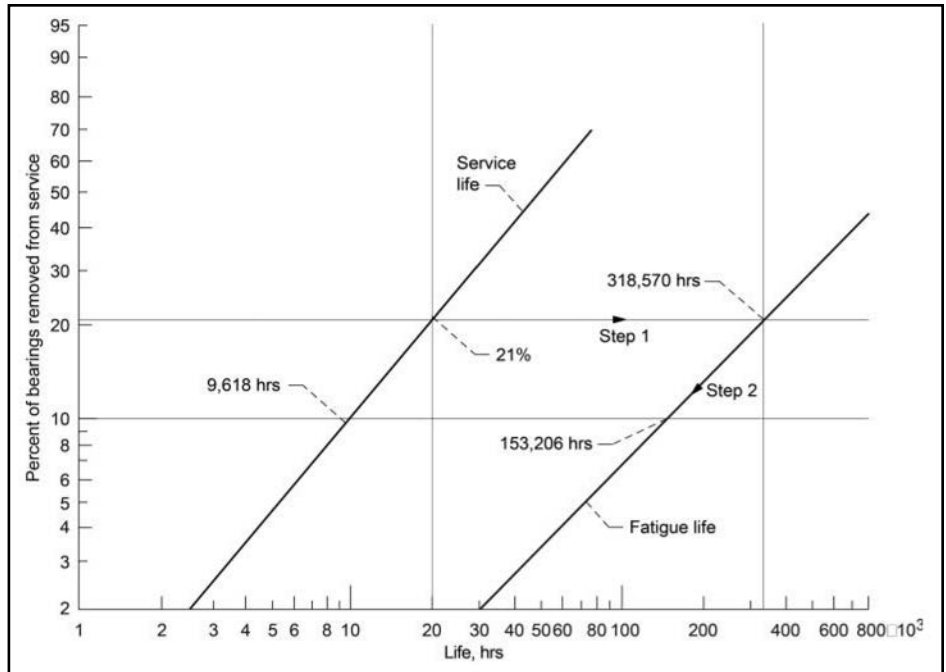

Figure 7 Aircraft engine bearing service and fatigue lives based on probable cause for removal and Weibull modulus,  $m$ , of 1.1 for 224,000 commercial aircraft engine ball and roller bearings over a period of 7 years.

lives, respectively. These results are shown in Figure 8. It can reasonably be concluded that most conservative bearing  $L_{10}$  service life calculation is obtained assuming an exponential distribution where we assumed  $m = 1.1$  (Fig. 7).

From Equation 6 the bearing  $L_{10}$  service life can benchmarked and calculated to the bearing  $L_{10}$  fatigue life as follows:

$$X = \left[ \frac{L_{serv}}{L_{10}} \right]^m \quad (8a)$$

$$L_{serv} = X^{1/m} L_{10} \quad (8b)$$

Where, in Equations 8a and 8b,  $L_{serv}$  is the service life at a 90% reliability or a 10% probability for bearing removal;  $X$  is the number of bearings that were removed from service because of fatigue divided by the total of all bearings removed from service regardless of cause; and  $L_{10}$  is the bearing calculated life based on fatigue at a 90% reliability or a 10% probability of fatigue failure.

An issue that is unanswered from the above analysis is the suggested correlation between the bearing location parameter,  $L_{\mu}$ , based on rolling-element fatigue and the  $L_{10}$  bearing service life using a Weibull modulus of 1.1. From Equation 1 and the work of Tallian (Zaretsky; Ref. 18) and Tallian (Ref. 21), it can be reasonably assumed that the location parameter  $L_{\mu}$ , or the time below which no bearing fatigue failure should occur, is  $0.053 L_{10}$  or for the commercial engine data,  $(0.053 \times 153,206 \text{ h}) = 8,120 \text{ h}$ . From Equation 8b:

$$\text{Let } X^{1/m} = 0.053 \quad (8c)$$

$$\begin{aligned} m &= 1.1 \\ X &\approx 0.04 \end{aligned} \quad (8d)$$

At a 90% reliability, where 10% of all the bearings in service are removed from service for cause, 4% of those bearings that were removed are because of fatigue or 0.4% of all the bear-

ings in service at that point in time. This compares to the 3% for the Naval Air Rework Facility bearing data and the ~5% commercial aircraft engine bearing rework data. Such a correlation at this time is speculative; more data are required. However, if such a correlation were to exist, it would greatly simplify the rolling-element bearing service life calculation.

**General Comments**

In the early years of the 20th century, rolling-element fatigue was the major cause for rolling-element bearing removal and limited the life and reliability of these bearings. Sadeghi et al. (Ref. 22) provide an excellent review of this failure mode.

Beginning with John Goodman (Ref. 5) and Arvid Palmgren (Ref. 2), the bearing industry has based the selection and sizing of these bearings on this failure mode. In the early gas turbine engines, engine life and reliability were linked to the fatigue life of those rolling-element bearings incorporated in the engine. Anecdotally, the life of these early engines and, thus, their bearings were limited to approximately 300 h. This can be compared to the estimated bearing fatigue life of over 100,000 h for the commercial aircraft engine bearings reported herein. Hence, the pre-1960 bearing service life was in fact the calculated bearing  $L_{10}$  fatigue life.

In the early years of the bearing industry, acid and base refractory air-melting methods were used to process steel. Major advances in steel processing have occurred, beginning in the 1950s with the introduction of vacuum-melting procedures that significantly increased the bearing fatigue life (Zaretsky; Refs. 18 and 23).

By the early 1960s bearing fatigue life increased approximately five times that upon which Lundberg and Palmgren (Refs. 11-12) benchmarked their life model to (Zaretsky; Ref. 18). By 1992 the bearing fatigue life was approximately 200 times that benchmarked by Lundberg and Palmgren; and with improved manufacturing techniques, heat treatment procedures, and lubricants, the bearing fatigue life can be as much as 400 times the Lundberg-Palmgren calculation.

Though bearing fatigue life has significantly improved, the other failure modes and/or causes for removal have remained relatively speaking unchanged and application dependent. The bearing removal and replacement rate may not be significantly better than that in the early 1960s. It is suggested that bearing removal rate is application-dependent. There is no analytical method for individually calculating the respective replacement rates and/or life except by accumulating a database from field experience. Though a bearing may no longer

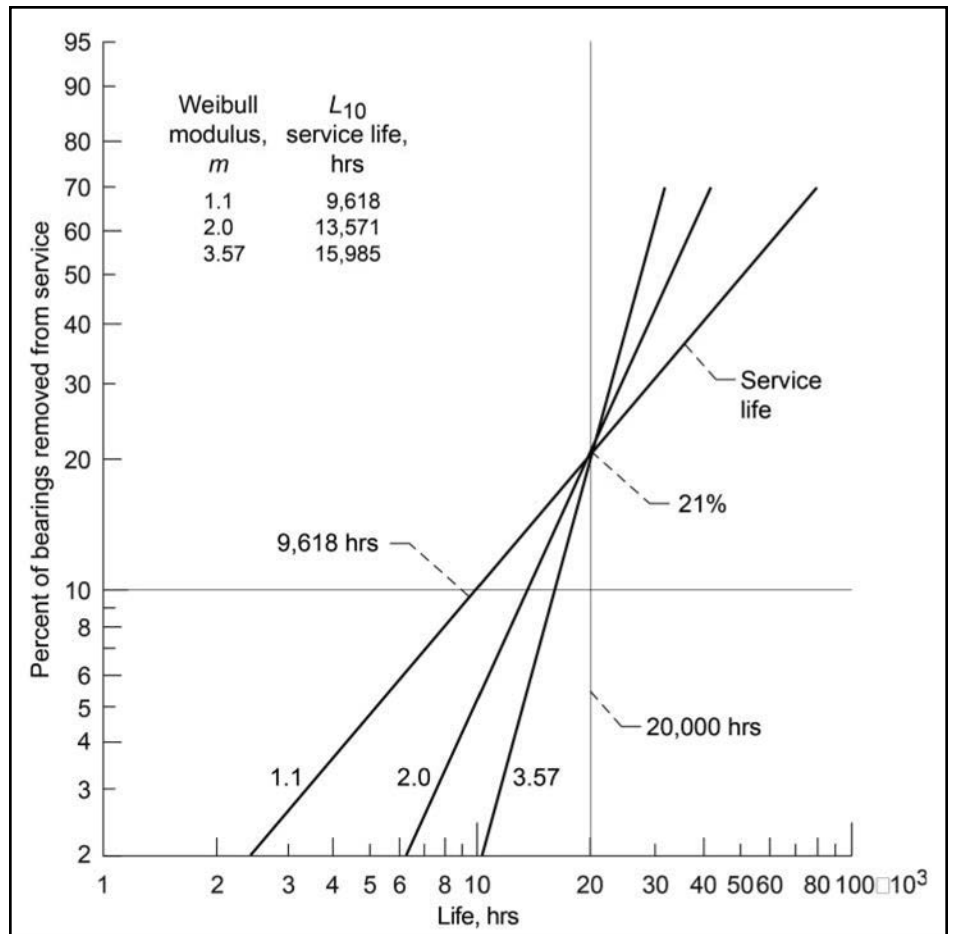

Figure 8 Effect of Weibull modulus,  $m$  (statistical distribution), on engine bearing service life.

be fit for its intended purpose for reasons other than fatigue, it may operate for extended periods of time in an application without causing secondary damage. However, once the application is shut down, reasonably prudent engineering and maintenance procedures would suggest that the bearing(s) be removed from service and replaced.

**Summary of Results**

In 1947 and 1952, G. Lundberg and A. Palmgren developed what is now referred to as the Lundberg-Palmgren model for rolling bearing life prediction based on classical rolling-element fatigue. Today, bearing fatigue probably accounts for less than 5% of bearings removed from service for cause. A bearing service life prediction methodology and tutorial indexed to eight probable causes for bearing removal, including fatigue, are presented, which incorporate strict series reliability; Weibull statistical analysis; available published field data from the Naval Air Rework Facility; and ~224,000 rolling-element bearings removed for rework from commercial aircraft engines. The following results were obtained:

1. Bearing service life  $L_{serv}$  can be benchmarked and calculated to the bearing  $L_{10}$  fatigue life as follows:

$$L_{serv} = X^{1/m} L_{10}$$

where,  $L_{serv}$  is the service life at a 90% reliability or a 10% probability for bearing removal;  $X$  is a fractional percentage calculated by taking the number of bearings removed from service because of fatigue, divided by the number of all bearings removed from service, regardless

- of cause;  $m$  is the Weibull modulus of all of the bearings removed from service; and  $L_{10}$  is the bearing calculated life based on rolling-element fatigue at a 90% reliability — or a 10% probability of a fatigue failure.
- The most conservative bearing  $L_{10}$  service life calculation is obtained assuming an exponential distribution where  $m = 1.1$ .
  - Of the ~224,000 commercial engine bearings removed from service for rework, 1,977, or 0.88%, were rejected because of fatigue.
  - From the Naval Air Rework Facility bearing data, eliminating rolling-element fatigue as a cause for removal, the  $L_{10}$  service life of these bearings would increase by approximately 3%. At 5,000 h or the bearing  $L_{10}$  fatigue life, 97% of the bearings would be removed from service for cause. **PTE**

**Erwin V. Zaretsky** is an engineering consultant to industry and government, noted author and lecturer, adjunct professor of engineering at Case Western Reserve University, and Distinguished Research Associate at the NASA Glenn Research Center (GRC) from where he is retired. He has over 50 years of experience in Mechanical Engineering related to tribology, rotating machinery, fatigue and probabilistic life prediction. He has written over 200 technical papers and two books and has lectured widely throughout North America, Europe, Asia and the Middle East. He is a Fellow of both the ASME and the STLE and a member of two ANSI/ABMA Committees on Rolling Bearing Standards. In 1998 he was appointed to the Senior Scientific and Professional Corp, the highest rank achievable by a Federal engineer or scientist. He has received four I-R 100 Awards established by the editors of R&D Magazine. In 1999 and 2013 the STLE presented Zaretsky with the Wilber E. Deutsch Memorial Award, which honors the most outstanding paper written on the practical aspects of lubrication. In 2012 the STLE presented Zaretsky with their International Award, STLE's highest technical honor for his lifetime of contributions to the field of tribology research. He is also the recipient of numerous NASA awards for his contributions to the Space Program, among which are the NASA Medal for Exceptional Engineering Achievement, NESC Director's Award and the Astronauts' Silver Snoopy Award. You can reach him at [evzaretsky@gmail.com](mailto:evzaretsky@gmail.com).



**Emanuel Branzai** is an aerospace rolling element bearings repair, reverse engineering, and failure analysis specialist. He helps customers to prepare FAA Part Manufacturing Approval (PMA) packages, improve bearing repair processes, and provide expert witness support for legal disputes. Emanuel has always enjoyed providing his expertise in problem solving — not only for bearings — but also for Six Sigma Quality Systems to improve and control manufacturing processes, material science, heat treatment, machine selection, and tooling and fixtures design. In fact, by this time he had helped in setting up three bearing repair facilities and an industrial robotic arm cycloidal gearbox manufacturing process. Now owner and CEO of IRB Associates, Inc., an engineering consulting company, he got into this line of business in 1986 when he was employed by Bearing Inspection, Inc., now a subsidiary of Timken Company. His favorite part of having an engineering consulting company business is providing problem solving, because it allows him to expand his expertise and have personal satisfaction in solving customers' difficulties. Also, it allows him to travel around the world. As a small business owner in California, Branzai is a devoted husband and grandpa of four grandchildren.



## References

- Palmgren, A. (1945) "Ball and Roller Bearing Engineering," G. Palmgren and B. Ruley (Trans.), SKF Industries, Philadelphia.
- Palmgren, A. (1924) "Die Lebgasdauer von Kugellagern (The Service Life of Ball Bearings)," *Zeitschrift des Vereines Deutscher Ingenieure*, 68 (14), pp 339-341. (NASA TT-F-13460, 1971).
- Zaretsky, E. V. (1998) "A. Palmgren Revisited — a Basis for Bearing Life Prediction," *Lubrication Engineering*, 54 (2), pp 18-23.
- Stribeck, R. (1907) "Reports from the Central Laboratory for Scientific Investigation," H. Hess, (Trans.), *ASME Transactions*, 29, pp 420-466.
- Goodman, J. (1912) "Roller and Ball Bearings," *Proceedings of the Institution of Civil Engineers*, 189, pp 82-166.
- Zaretsky, E. V. (2010) "Rolling Bearing Life Prediction — Theory and Application," *Recent Developments in Wear Prevention, Friction and Lubrication*, Nikas, G. K. (Ed.), pp 45-136, Research Signpost: Kerala, India.
- Colvin, F. H. and F.A. Stanley. (1914) *American Machinist Handbook and Dictionary of Shop Terms*, 2nd Ed., McGraw-Hill, New York.
- Styri, H. (1951), "Investigations of Rolling Bearings at SKF Industries, Inc., Review of Current and Anticipated Lubricant Problems in Turbojet Engines," NACA RM 51D20.
- Weibull, W. (1939) "A Statistical Theory of the Strength of Materials," *Inginiors Vetenskaps Adademien*, 151.
- Weibull, W. (1939) "The Phenomenon of Rupture," *Inginiors Vetenskaps Adademien*, 153.
- Lundberg, G. and A. Palmgren. (1947) "Dynamic Capacity of Rolling Bearings," *Acta Polytechnica Mechanical Engineering Series*, 1(3).
- Lundberg, G. and A. Palmgren. (1952) "Dynamic Capacity of Roller Bearings," *Acta Polytechnica Mechanical Engineering Series*, 2(4).
- Averbach, B. L. and E.N. Bamberger. (1991) "Analysis of Bearing Incidents in Aircraft Gas Turbine Mainshaft Bearings," *Tribology Transactions*, 34(2), pp 241-247.
- Cunningham, J. S., Jr. and M.A. Morgan. (1979) "Review of Aircraft Bearing Rejection Criteria and Causes," *Lubrication Engineering*, 35 (8), pp 435-441.
- Johnson, L. G. (1964) "The Statistical Treatment of Fatigue Experiments," Elsevier Publishing Co., Amsterdam, The Netherlands.
- Savage, M., K.C. Radil, D.G. Lewicki and J.J. Coy. (1989) "Computerized Life and Reliability Modeling for Turboprop Transmissions," *Journal of Propulsion and Power*, 5(5), pp 610-614.
- Vlcek, B. L., R.C. Hendricks and E.V. Zaretsky. (2003) "Determination of Rolling-Element Fatigue Life from Computer Generated Bearing Tests," *Tribology Transactions*, 46(3), pp 479-493.
- Zaretsky, E. V. (Ed.). (1992), *STLE Life Factors for Rolling Bearings*, STLE SP-34, *Society of Tribologists and Lubrication Engineers*, Park Ridge, IL.
- Zaretsky, E. V. and E.V. Branzai. (2007) "Model Specification for Rework of Aircraft Engine, Power Transmission, and Accessory/Auxiliary Ball and Roller Bearings," NASA/TP-2007-214463.
- Zaretsky, E. V. and E.V. Branzai. (2005) "Effect of Rolling Bearing Refurbishment and Restoration on Bearing Life and Reliability," *Tribology Transactions*, 48(3), pp 425-435.
- Tallian, T. E. (1962) "Weibull Distribution of Rolling Contact Fatigue and Deviations Therefrom," *ASLE Transactions*, 5(1), pp 183-196.
- Sadeghi, F., B. Jalalahmadi, T.S. Slack, N. Raje and N.K. Arakere. (2009) "A Review of Rolling Contact Fatigue," *Journal of Tribology*, 131(4), Art. No. 041403.
- Zaretsky, E. V. (2012) "Rolling Bearing Steels — a Technical and Historical Perspective," *Materials Science and Technology*, 28(1), pp 58-69; discussion, 28(11), pp 1358-1367 (2012).

# Schaeffler

DOUBLES DOWN ON INNOVATION AND PRODUCT DEVELOPMENT IN NORTH AMERICA

Schaeffler Group USA Inc.'s latest \$36.5 million capital investment to its Fort Mill, South Carolina campus included the expansion of one of the site's manufacturing plants, the construction of a new administrative building and a re-worked plant entrance. In the U.S., Schaeffler employs approximately 6,000 people at eight factories and three technology centers spread throughout South Carolina, Ohio, Missouri, Michigan and Connecticut.

PTE recently sat down with David Thompson, president of Schaeffler's Industrial division in the Americas, to discuss these investments as well as global competition, bearing technology, condition monitoring, workforce challenges and the future of industrial manufacturing.

## The North American Market

"As we started talking more about today's price pressure, we began discussing what value we're really bringing to our customers in 2017," said Thompson. "The goal was to provide flexibility, enhanced communication and get our products faster—and more efficiently—to the North American market."

This includes focusing on both customizable products and standard catalog offerings. It also means reinforcing the company's commitment to do what it does best: Produce quality bearings at a competitive price point. Investments like the Fort Mill expansion project (which created 100+ new jobs in South Carolina) certainly help this effort.

## Global Competition

Flexibility is so important in today's market, according to Thompson. "You have to provide more than just a component, you need to look at the system as a whole and determine what solution best fits the customers' needs."

The competition is getting better at what they do, so we need to focus on our product strengths when designing new and innovative products. This includes examining surface hardness and the surface treatment of bearings, for example, and looking at areas such as power density."



## Condition Monitoring

One area that has seen improvements is condition monitoring. Thompson says Schaeffler's VarioSense bearings make it possible to monitor central machine and process parameters much more easily. The sensor is integrated right into the bearing, which allows a module to be equipped with several different sensors at the same time. Measurements can include speed, temperature, displacement, angle, load, direction of rotation and vibration/acceleration.

SmartCheck, an advanced condition monitoring system that can fit in the palm of your hand, is another add-on product that helps engineers understand the loads and predict failures. "We're using this technology on wind turbines to determine predictive maintenance intervals," Thompson said. "This helps us schedule the right maintenance operations at the right time."

## Look Toward Other Market Segments

Regarding power density, Thompson plans to lean heavily on the automotive side, where reducing the carbon footprint and producing efficient transmissions have driven the company towards digitalization.

"We have different power densities in the industrial world, it's a little more challenging, but it's becoming more important," Thompson said. "We need to focus on the data that



we're generating from our industrial components, and determine the best way to utilize this data to bring value to the end user."

Thompson notes that the automotive industry has gone through some dramatic changes, and the result is much more integration with its suppliers. "We have to follow a similar path to be successful in the industrial segments," Thompson said.

### Engineering Pedigree

Challenges remain in replacing skilled workers who are getting ready to retire with years of mechanical engineering experience. There's a war on talent, but Schaeffler continues to actively pursue solutions.

The company's apprenticeship programs, for example, were highlighted in a recent White House roundtable discussion on vocational training programs and continuing educa-



tion in the United States with President Donald Trump and German Chancellor Angela Merkel.

"I've often thought we should consider rotating some of our engineers around with our customers and vice-versa," Thompson said. "The more our engineering staff can speak the same language with our broad customer base, the better."

### What Comes Next?

"Obviously, the Industrial Internet of Things (IIoT), digital manufacturing and mechatronics will continue to accelerate for both our industrial and automotive segments," Thompson said.

The company would like to take some of these new technologies on the low-volume side and work directly with its suppliers to leverage these advancements.

"We're seeing this in aerospace, for example, where our team is constantly looking at ways to make bearings quieter, more flexible and much more efficient. This technology can be utilized in other industrial markets, and I think we're going to have to focus on areas like that to really progress."

([www.schaeffler.us](http://www.schaeffler.us))

## Rocky Mountain Technologies

### State of the Art Custom Design and Consulting Services

Where Innovation and Solutions Meet

- We Deliver Custom Motors and Drives
- We Design Your Custom Motors and Drives
- We Assist with In-House Design and Consulting
- Prototyping, Pre-Production, Product Performance
- Strategic Partners Volume Sourcing



**(406) 552-4260**

[sales@rockymountaintechnologies.com](mailto:sales@rockymountaintechnologies.com)

Rocky Mountain Technologies, P.O. Box 210, Basin, MT 59631

BEYTA GEAR SERVICE

PUTTING  
A LIFETIME

OF

GEAR  
DESIGN

EXPERIENCE

TO WORK FOR YOU

- Reverse engineering
- Gearbox upgrades
- Custom gearbox design
- Specification development
- Project management
- Vendor qualification
- Design reviews
- Bid evaluations
- Tooling design
- Customized gear training
- Equipment evaluation
- Custom machine design

**Charles D. Schultz**  
[chuck@beytagear.com](mailto:chuck@beytagear.com)  
**[630] 209-1652**

[www.beytagear.com](http://www.beytagear.com)

## Thomson Industries

COLLABORATES WITH RESEARCH TEAM TO DEVELOP NEW TESLA COIL DESIGNS

Thomson Industries has donated a high-precision ball screw assembly to The Geek Group National Science Institute in Grand Rapids, Michigan, to help develop revolutionary designs of Tesla Coils (TC). An ambitious R&D program has been initiated there to discover new uses for the TC with help from a new automated process for winding coils.

Thomson was selected because of their top-notch application engineering support and breadth of product offerings, which enabled delivery of an optimal complete ball screw assembly. That Thomson ball screw assembly will help The Geek Group's high-energy engineering team convert from typical manual winding to a much faster, more accurate automated process for winding thousands of coils required to conduct their experiments.

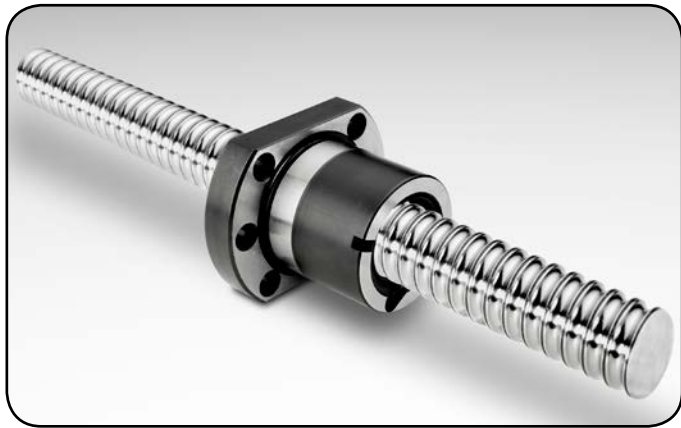

A Thomson customer support engineer guided The Geek Group engineering team in selecting the exact configuration to best match their needs. The product selected was a quick-install ball screw assembly that avoids any precision problems that may result from assembling components on site. The final configuration consisted of a Thomson FSI Style ball nut along with an eight-foot-long ball screw just under an inch in diameter.

"We set our IRC team on the task of finding the best linear motion technology in the industry," said Chris Boden, CEO of The Geek Group. "The team, composed of a couple hundred experts from many science and technology disciplines, analyzed about a dozen different products and concluded that only the Thomson drive could do exactly what we needed and exactly how we wanted to do it".

The TC production program has already begun, and The Geek Group has plans for experimenting with larger coils in the future. ([www.thomsonlinear.com](http://www.thomsonlinear.com))

## Motion Industries

OPENS NEW DALLAS DISTRIBUTION CENTER

Motion Industries, Inc. recently announced the successful move to its newly built distribution center (DC) at 200 W. Trinity Boulevard, Grand Prairie, Texas — in the center of the DFW Metroplex. Managed by Dan Krska, the new facility is less than a half mile off of a major highway, close to LTL carriers, and close to both of the area's major airports.



"The increase in square footage allows for a deeper and broader array of product offering for our customers. In addition, the state-of-the-art material handling equipment will ensure timely and accurate order processing," said Joe Limbaugh, Motion Industries vice president, operations/distribution/properties. "In addition to being efficient, the new distribution center is simply beautiful. It showcases the Mi Workplace commercial design standards in the offices, conversion shop and warehouse."

Krska added, "Our relocation weekend was a great success due to the preparation, leadership, and execution of the game plan. The folks really grasped the concept and embraced the task. I was truly humbled to watch 150 Motion employees, with the help of contracted labor, all work together to finish ahead of schedule. Once again, it proves why I am proud of this company."

The new DC officially started operation on Sunday, March 5, at the end of the relocation weekend. Brand new hanging and roller conveyor lines as well as a bevy of forklifts efficiently move product orders throughout the warehouse portion of the 156,000 sq. ft. facility, which nets the company almost 50,000 square feet over the previous location. The increased number of shelves and docks within this expanded footage allows for greater inventory breadth and depth, as well as faster picking and delivery to customers. This DC houses approximately 50,000 SKUs.

"In addition to the availability of more product, the Motion Industries branches will have access to a facility that is designed for on-site customer interaction. Spacious conference rooms, Red Zone tour paths and a Motion Experience Center are part of the design," said Limbaugh.

([www.motionindustries.com](http://www.motionindustries.com))



# SKF

REMANUFACTURING SERVICES PROVIDE TIMELY AND COST-EFFECTIVE SOLUTIONS

SKF remanufacturing services for industrial gearboxes provide cost-effective solutions to refurbish and/or upgrade obsolete or damaged systems and quickly return them to service. A systems approach is applied to diagnose root causes of gearbox failure and prescribe technical remedies to implement proper fixes. This process further engages proprietary modeling and simulation software combined with engineering expertise to enable performance upgrades. All types and brands of gearboxes represent candidates for SKF remanufacturing services implemented at dedicated SKF gearbox repair centers.

The process begins with on-site inspection and initial diagnosis before a gearbox is sent to one of SKF's repair centers. SKF service engineers at the repair center then disassemble, clean, inspect, and analyze critical components such as gears, bearings, shafts, and seals. Root cause analysis pinpoints why a gearbox has failed or experienced unplanned stops. Refurbishment is carried out as a complete machine renovation involving the replacement and/or reworking of parts and housings.



Refurbishment presents an opportune time to upgrade with value-added design, engineering, components, and/or precision machining for enhanced gearbox system operation. Upgrades can focus on increased power and output torque, higher service factors, and extended MTBF (Mean Time Between Failures), among other parameters.

After all work is completed, SKF performs final testing and installs the gearbox for a return to full productivity and efficiency.

Cost-benefit analysis has shown that significant cost savings may be achieved by remanufacturing a gearbox, which is typically 40% less expensive than a new unit and can be delivered much more quickly—especially important for large, purpose-built industrial gearboxes.

Gearbox remanufacturing conducted by skilled specialists employing advanced engineering and world-class components ultimately can contribute to reduced total life cycle costs, fully exploited service life, cost savings, improved up-time from increased machine availability, reduced environmental impact in terms of less energy and less scrap, and enhanced asset reliability. ([www.skfusa.com](http://www.skfusa.com))

## CUSTOM TUBULAR COMPOSITE COMPONENTS

QA1's Advanced Materials Division is able to take your composite concept from initial design to full production, all at our facility in Lakeville, MN. Because everything is designed and manufactured in-house, QA1 can tailor the product to your needs.

- Application and design engineering
- 3D modeling, simulation and prototyping
- Testing and product validation
- Manufacturing and quality control



ISO 9001:2008 Certified

# QA1

P: 800.721.7761  
QA1.net/custom

F: 952.985.5679  
sales@QA1.net

# SUHNER

  
Transmission expert.



## Flexible shafts for special machinery

Efficient automation starts with efficient shafts.



**SUHNER MANUFACTURING, INC.**  
Rome, GA 30161  
706-235-8046  
[www.suhner.com](http://www.suhner.com)  
[info.usa@suhner.com](mailto:info.usa@suhner.com)

**SUHNER**  
EXPERTS. SINCE 1914.

# Pack Expo: The Push to Automation

With Pack Expo Las Vegas around the corner, we took a look at the state of the packaging industry today to see what you can expect at the show. The answer is more automation.

Alex Cannella, Associate Editor

Jeff Pike, Yaskawa's director of motion group marketing, recalls a time not so long ago when the packaging industry was very different from how it is now. He remembers a time where packaging machines were less complex creations compared to today's multi-servo constructions.

"When I started calling on packaging accounts when I was in sales, every packaging machine had one induction motor and was sort of this Rube Goldberg machine of chains and cams to accomplish all the motion...Over the last 15 years, everything's converted from that type of architecture where there was really fixed mechanics with one motor to now when you walk around the show, pretty much every machine you see has 10-15 servo axes and each axis of motion is individually controlled."

How far we've come.

But like any other industry, packaging is constantly evolving at an ever increasingly breakneck pace, and that means that manufacturers need to be constantly paying attention to stay savvy of the latest industry developments to take advantage of. And it just so happens that the best opportunity to do exactly that is coming up in September. The latest rendition of Pack Expo Las Vegas is just around the corner, and it's going to be the place to see what's happening in the U.S. packaging industry for decision makers and machine builders alike.

For Kollmorgen, this will be their sixth Pack Expo, and according to their Business Development Manager, Bill Sutton, those machine builders are a prime reason for them to attend the show. Alongside those machine builders, however, are also those machine builders' customers. For Kollmorgen, Pack Expo offers not just an opportunity to talk shop and drum up business

with their customer base, but also to meet and interchange ideas with the next party on the chain, their customers' customers.

"The majority of our North American customers and many of our international customers exhibit at Pack Expo," Sutton said. "We provide innovative technology solutions for many

of the machine builders that exhibit at the show. We also we provide unique value ideas to the end-user customers that are there to see those machine builders. Both our customers and our customers' customers come to Pack Expo, and it's a great opportunity for us to display our new technology in a creative way to them."





Machine builders in particular will find a lot to see on the showroom floor. As one of the most visible epicenters of the U.S. packaging industry, the show will feature exhibitors of every stripe showing their latest mechanical innovations.

“There’s a lot of machines on the show floor,” Laura Thompson, senior director of expositions at PMMI, said. “People come to this show and they can see everything in action. And they can find basically anything they need, from components to seeing a full packaging line in action to seeing the finished materials and containers. It’s your one-stop shop on where to find everything and stay up on the latest trends in the industry.”

That’s not just a bullet point that PMMI puts on their website to draw attendees to the show. Long-time exhibitors like Yaskawa also believe that the show is a prime location to see what direction the industry is heading in.

“If you want to see what machine builders are doing...Pack Expo is really the place to see all of that,” Pike said. “Outside of just the packaging industry, it’s really where a lot of the technology is happening just from a machine building standpoint.”

### Displays in Motion

Visitors won’t get to just set eyes on the latest in packaging machinery — in most cases, they’ll get to watch it in action. Often at a show, most booths are stocked with rows of static products

with a single machine that may or may not be running as a centerpiece. At Pack Expo Las Vegas, many exhibitors are filling their booths with fully functional, automated demonstrations of their products in action.

“When you look at our booth today, you don’t see any static products,” Pike said. “What you see is application solutions for picking, packing, palletizing, and you see the integration of motion and robotic technologies together on those application solutions...Everything that we take to that show now is in motion and being demonstrated.”

Yaskawa will have a wide array of fully automated systems on display at their booth in different cells. Front and center will be their palletizing/de-palletizing cell, in which Yaskawa will be demonstrating safety interactions between the cell and an operator. Yaskawa will also be putting on a few demos at their booth, including one of a delta robot running on Yaskawa’s IEC-61131 motion controller and another featuring case packing with T-Bots and articulated robot arms. Additional displays will include a cell with two delta robots doing high speed picking and circulation of products on a line, a high-speed robot on display, and even a collaborative robot handing out beer.

In addition, Yaskawa will also be displaying its control solutions. Most prominent amongst these will be their one-size-fits-all control architecture, which they’re designing to work on everything from a T-Bot to a delta. The

concept is that if a single application code works with multiple kinds of robots, customers can interchange different mechanisms as needed without having to rewrite the entire code to use them, which reduces the technical requirements for the company to make such a change.

“The control solution is just as important as the mechanical piece,” Pike said. “That’s where we’re driving a lot of our product development: developing a control architecture that allows customers to use the whole continuum of product types, from just buying individual axes to buying a t-bot to buying an articulated arm or doing a specialized mechanism, all inside of one software environment.”

Kollmorgen, meanwhile, will be displaying two of their comprehensive, full control systems in operation at their booth. The first will be an aquarium designed to show off Kollmorgen’s hygienic motors and IP67 drive system. Motors will be “cleaned” using water spray throughout the show simulating their resistance to daily cleaning routines, and thus value in food processing applications, will also be put on display.

The second display will be a pair of four-foot tall Rock’em Sock’em Robots complete with 14 axes of motion entirely powered by Kollmorgen products, including their automation suite, actuators and servomotors. The robots won’t just be fully functional; attendees will even be able to get hands on and play around with them.

According to Sutton, the purpose of the booth is to highlight the company’s ability to both construct full system solutions of their own and co-engineer motor and drive solutions that work in tandem with other companies’ control solutions.

While at the show, Kollmorgen will also be unveiling their newest servomotor, the AKM-2G, which according to Sutton, features 30-50 percent higher torque density over Kollmorgen’s previous products and conventional standards.

Regal Beloit’s main feature will be their System Plast Modsort right angle transfer station, which is designed to transfer packages based on a package’s momentum.

“The Modsort station features the System Plast 2253RT roller top belt, which allows it to uniquely transfer and divert packages based on the sphere’s vector speed and direction while also featuring a 1-inch, on-center sphere array to allow for very small packages to be diverted,” Mike Suter, Regal Beloit America’s vice president of marketing and power transmission solutions, said. “The station can divert on the fly or stop and divert at a true 90-degree angle, and is ideal for poly-bags and small packages while also easily handling boxes.”

According to Suter, Modsort stations can be placed end-to-end or integrated with a conveyor depending on your needs, and is also customizable to work with picking and packing stations. It can also be retrofitted into an existing conveyor system.

The Modsort will be on display front and center as a four-square conveyor system designed to show different possible Modsort modules and configurations to illustrate many of the system’s benefits. Alongside the Modsort, Regal Beloit will be showing off many of their existing products, including Hub City HERA right angle gear reducers, Grove speed reducers, Marathon Motors, SealMaster and McGill bearing products and other System Plast conveying components.

For the first time in North America, Festo will be unveiling its Motion Terminal VTEM, a digital pneumatic system that can replace 50 different pneumatic components with downloadable software apps. Festo says the Motion Terminal VTEM is the first of its kind digital pneumatic system— a controller and flexible valves. Combinations of apps are used to perform various functions such as motion with leak detection and energy savings or proportional directional motion. At the Festo Pack Expo booth, five different VTEM controlled motion functions will be showcased in active demos. Festo will also be showing its range of systems optimized for motion in packaging applications including gantry systems, IO-Linked enabled devices, and pneumatic and electric motion control on a single control platform.

Amongst their numerous offerings,

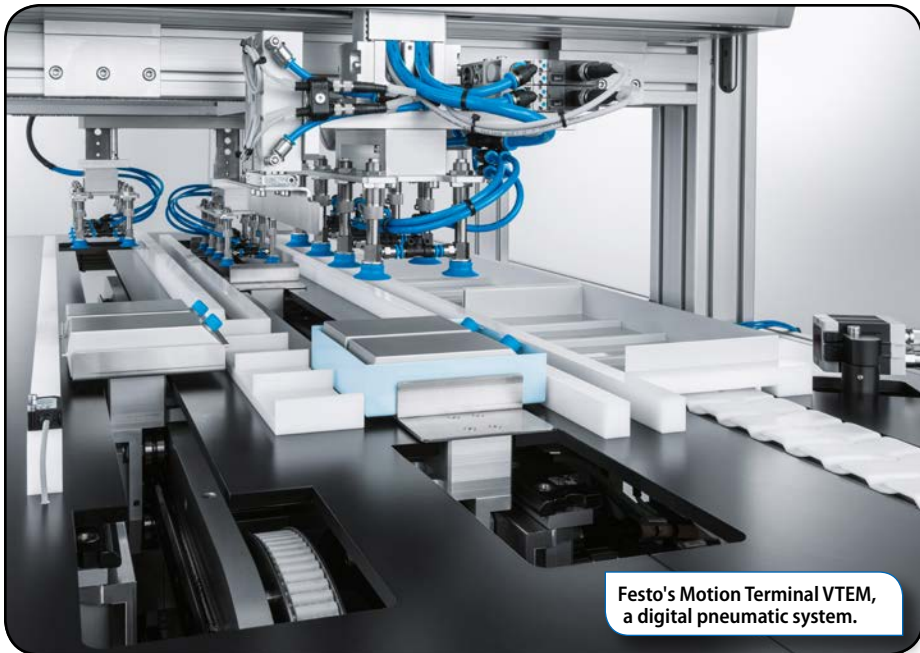

Festo's Motion Terminal VTEM, a digital pneumatic system.

Siemens will be displaying their Sinamics G120C drive, which recently came out with a new AA frame size that’s smaller than previous G120C A models but offers equivalent power ratings. This new “tiny drive” is designed to save up to 32 percent of space in a control cabinet compared to the A size it’s replacing. The G120C also features cable lengths of 50 meters shielded and 150 meters unshielded.

Siemens will also be bringing back their Mechatronics Concept Designer, which was amongst the products they brought to Pack Expo last year. The Mechatronics Concept Designer is one of Siemens’ CAD programs that features two different modes. In manual mode, users can trigger individual axes, while production mode allows axes to be moved synchronously towards each other on electrical cam discs. The Mechatronics Concept Designer is an ideal way to design a machine and double-check its functions for optimization before it’s actually built.

Taking center stage at Bosch Rexroth’s showcase will be their Industrial Internet-centric analytics and control equipment, the newest addition of which is their IoT Gateway. Bosch Rexroth’s Gateway is a product that takes in collects a constant stream of data from sensors on a machine or part, such a motor or drive, for example, and sends that data onward to be analyzed. Vibration, temperature, per-

formance, the Gateway monitors it all over time.

What the Gateway can’t do, however, is allow users to study the data. While users can study what the Gateway is picking up in real time, it doesn’t store the data, but instead works as a conduit to interpret and transfer the massive waves of data produced by constantly monitoring a machine to an analysis tool or software.

“You have a simple interface to see what’s going on live,” Brian Schmidt, application supervisor at Bosch Rexroth, said. “But most likely, you’re going to want to do something with that data more than just looking at it real time. You’re going to want to analyze it, look for trends, like maybe temperature changes or vibrations that get worse over time.”

It should come as no surprise that Bosch already provides products to complement the IoT Gateway and provide complete data analytics and enterprise management solutions. The Production Performance Manager (PPM), developed by Bosch Software Innovations, is one such software product on display at Pack Expo. Using PPM’s toolset, engineers and plant managers can analyze trends over time in their machines to better understand the causes of reduced productivity, receive early indicators of mechanical failure before a breakdown occurs, and ensure corrective actions are taken us-

ing the Ticket Management feature.

On the more physical side of things, Bosch Rexroth will be displaying single-cable motors that feature a cable link that can be expanded as far as 75 meters, alongside their usual drives and control systems. However, Bosch Rexroth's focus currently is on the automation and incorporating Industrial Internet technologies into their packaging solutions.

"The trend in the market is more line integration in terms of adding robotics to the line, and also the evolution of the Internet of Things," Kin Yung, director of the printing and packaging industry sector at Bosch Rexroth, said. "So our main focus this year is on connected automation."

### Driving Automation

Bosch Rexroth's focus going into 2017's Pack Expo shouldn't be much of a shock. There have been whispers of the advent of the "Fourth Industrial Revolution" for years, and the technological leaps it promises have been a central focus of almost every trade show or conference to happen this year. Much like the rest of the industrial world, packaging isn't just pushing into a brave new world of automation—many would argue that it's already there.

But what about the other side of the equation that Yung sees the industry shifting towards: robotics? It might not be a surprise to see robots becoming increasingly implemented in the industry as a whole, but the shift that is more eye-catching is that robots are

becoming a vital part of the packaging machines themselves.

According to Pike, robotics and motion control are becoming increasingly intertwined bedfellows in the packaging industry. Robotic applications are starting to require more sophisticated motion control solutions, motion control guys will find an ever-hungrier market for their products in the robotics sector, and the actual machine builders are going to see more and more competitors with increasingly sophisticated and competitive machines utilizing the latest results of the increasingly solidified union between those two fields.

Yaskawa has already begun responding to the shift in demand accordingly. In recent years, the company's robotics and motion control groups have started coming together and undergone joint ventures.

"We saw that progression happen in the packaging industry where people were starting to have robots and standard motion technology inside of the same machine and they sat together and needed to interact," Pike said. "And really when we started digging into this five years ago, what customers were saying was 'I'm starting to do this. I'm starting to put a robot inside a machine or right next to a machine. I want to reduce the number of processors. I want to reduce the number of controllers in my system. I want to bring all this stuff together.' That's when we started saying 'ok, we have some value to bring to this space' rather than just selling components."

According to Pike, demand has only risen since Yaskawa's two groups began cross-pollinating, and he doesn't see it stopping anytime soon.

"The interest in robotic technology and more advanced motion control is just increasing," Pike said. "What we see driving that...is the end users are asking for more effective, more flexible machines, mobile robotics, things that are just not fixed anymore."

Perhaps most telling of the direction that the packaging industry is going isn't what's expected to happen at Pack Expo, but what's already happened at Interpack. When Yaskawa attended the show, they witnessed first hand the industrial shift to lean more heavily on robotics and automation in full force in Europe.

"When we went to Interpack, we saw that everywhere," Pike said. "And I think the manufacturers in the U.S. are a little bit behind that, so that's really what we're going to be looking for at [Pack Expo] this year is how much is that starting to be adopted in the U.S.—that concept of a purpose-built mechanism rather than a gantry or a t-bot or h-bot or some sort of a cartesian mechanism."

Bosch Rexroth, similarly, was on hand at Interpack as an exhibitor, where they were amongst the throng of companies showing off their latest advances in Industrial Internet technology as they intend to be at Pack Expo. Amongst their

Siemens' G120C drives, the smallest of which, the AA, will be on display for the first time at Pack Expo this year."



exhibits, they showed off simulation software that could simulate a virtual twin of a potential packaging machine and how it would perform before the machine was ever built.

"They can do the simulation even down to the motor performance..." Yung said. "Do an animation to simulate that virtual machine. So we can do like virtual commissioning, basically."

### Pack Expo: Keystone for the Industry

How the U.S. packaging industry will reflect these shifts will be seen soon enough. Pack Expo Las Vegas is coming up fast next month, and there will be plenty for all in attendance to see for themselves what direction the industry is moving in. And not only will attendees be able to see the future exhibited on the floor, they'll also be able to check out Pack Expo's extensive educational offerings, the most notable of which will be the 54 presentations that will make up Pack Expo's Innovation Stage.

The Innovation Stage will be a central hub at the show, with presentations running throughout each day right on the trade show floor. Presentations will cover the latest advances in the industry and are designed to pack as much information as possible while remaining unobtrusive affairs with careful attention paid to convenience and ease of access.

"In our outreach to attendees, we've always been told they want something that's easy for them to drop in, something on the show floor," Thompson said. "They don't necessarily want to commit to going to a meeting room for two hours. These are nice, quick, easy to access presentations. They're about 30 minutes, right on the show floor, that are free of charge."

Sutton's coworkers at Kollmorgen, both sales representatives and machine tool builders alike, have found the brief seminars to be filled with interesting, useful information on everything from trends in the industry and spotlights on specific topics like connectivity to new products that either complement or compete with their own.

In addition to the Innovation Stage, Pack Expo will also feature a few individual workforce seminars. One occur-



Also at Kollmorgen's booth: an aquarium designed to show off their motors' resilience to water.

ring before the show will focus on the benefits of risk assessment programs, as well as how to go about conducting them, while another during the show will look at best practices for training your employees at every level, from technicians to even other trainers.

But regardless of what lessons might be learned next month at Pack Expo, Pike is excited to be here in this moment in the industry's progression.

"It's an exciting time in the industry, to be there as things are transitioning to new technology," Pike said. "As a vendor, it makes what we do a lot more fun. [There are] things coming up that are really challenging. Like, how do I put this robot on the back of a vehicle and let it drive around and pick things? Or how do I look into the back of a truck and unload a set of cases? Or how do I pack a case that has mixed product from five different lines and throw a hat in there? We're all engineers and we like to solve fun problems. It's making the industry really interesting and exciting right now."

The solutions to those problems, and the many problems like them, are the future of the packaging industry. And they'll be on display right before your eyes at Pack Expo, Sept. 25-27 at the Las Vegas Convention Center.

#### For more information:

Bosch Rexroth AG  
Phone: (800) 739-7684  
[www.boschrexroth.com](http://www.boschrexroth.com)

Festo USA  
Phone: (800) 993-3786  
[www.festo.com](http://www.festo.com)

Kollmorgen  
Phone: (540) 633-3545  
[www.kollmorgen.com](http://www.kollmorgen.com)

Pack Expo 2017  
Phone: (571) 612-3200  
[www.packexpolasvegas.com](http://www.packexpolasvegas.com)

Regal Beloit Corporation  
Phone: (608) 364-8800  
[www.regalbeloit.com](http://www.regalbeloit.com)

Siemens USA  
Phone: (800) 743-6367  
[www.siemens.com](http://www.siemens.com)

Yaskawa America Inc.  
Phone: (800) 927-5292  
[www.yaskawa.com](http://www.yaskawa.com)

For Related Articles Search

packaging

at [www.powertransmission.com](http://www.powertransmission.com)

### September 6–8—AGMA 2017 Bevel Gear System Design

San Diego, CA. Learn how to design and apply bevel gears systems from the initial concept through manufacturing and quality control and on to assembly, installation and maintenance. Engage in a practical hands-on guide to the bevel gear design, manufacture, quality control, assembly, installation rating, lubrication and, most especially, application. Engineers, technicians, and others involved in the selection, application and/or design of bevel gear systems should attend. Ray Drago is the instructor. For more information, visit [www.agma.org](http://www.agma.org).

### September 13–15—VDI International Conference on Gears 2017

Garching, Germany. Supported by national and international associations, the conference brings together over 600 leading experts from the international gear and transmission industry. The 2017 conference will be a unique meeting point for equipment manufacturers, producers and researchers of gear and transmission systems to present their new solutions, latest research results and technical ideas. There is still room for improvement in the field of gears and transmissions, how gears can contribute to increasing energy efficiency, reducing resource consumption and how new technologies will be incorporated in the powertrain. For more information, visit <https://www.vdi-wissensforum.de/en/event/international-conference-on-gears/>.

### September 18–22—AGMA 2017 Basic Training for Gear Manufacturers

Oak Lawn, Illinois. Learn the fundamentals of gear manufacturing in this hands-on course. Gain an understanding of gearing and nomenclature, principles of inspection, gear manufacturing methods, and hobbing and shaping. Utilizing manual machines, develop a deeper breadth of perspective and understanding of the process and physics of making a gear as well as the ability to apply this knowledge in working with CNC equipment commonly in use. This course is taught at Daley College. A shuttle bus is available each day to transport students to and from the hotel. Although the Basic Course is designed primarily for newer employees with at least six months' experience in setup or machine operation, it has proved beneficial to quality control managers, sales representatives, management, and executives. Course instructors are Dwight Smith, Allen Bird and Peter Grossi. For more information, visit [www.agma.org](http://www.agma.org).

### September 19–22—Process Expo 2017

McCormick Place, Chicago, Illinois. Process Expo represents the pinnacle of food technology bringing together the world's most successful food and beverage processors, equipment manufacturers and leaders in the field of academia. It is owned and organized by the Food Processing Suppliers Association (FPSA), a global trade association serving suppliers in the food and beverage industries. Nearly 600 food processing and packaging exhibitors will display machines, products and services specific to food and beverage processing. For more information, visit [www.myprocessexpo.com](http://www.myprocessexpo.com).

### September 25–27—Pack Expo 2017

Pack Expo Las Vegas, North America's largest packaging event of 2017, will bring together the solutions needed to launch new products and solve production issues. Corporate managers,

engineers, sales managers, plant managers, manufacturers and production supervisors, brand and marketing managers, quality controllers, purchasers, research/development and package designers from a wide variety of consumer packaged goods companies (CPGs) will be in attendance. More than 2,000 exhibitors will display state-of-the-art technologies, equipment and materials. The show is co-located with the Healthcare Packaging Expo, bringing pharma/biopharma, nutraceutical and medical device manufacturers together for the latest trends, innovations and solutions. For more information, visit [www.packexpolasvegas.com](http://www.packexpolasvegas.com).

### September 25–28—Canadian Manufacturing Technology Show 2017

The International Center, Mississauga, Ontario. The Canadian Manufacturing Technology Show, based in Toronto, is Canada's national stage for manufacturing technologies, best practices and industry connections. For more than 30 years, the CMTS audience from within Canada's leading industries, including automotive and aerospace, have come together to source solutions and knowledge from the global leaders in machine tools and tooling, metalworking, and advanced manufacturing. CMTS provides attendees from all walks of manufacturing an experience they never forget and often repeat: a hands-on, flexible learning environment of revolutionary technologies. Experience more than 3,000,000 lbs. of manufacturing equipment in action and connect with 700+ suppliers of technologies and solutions under one roof demonstrating live, working equipment. For more information, visit [www.cmts.ca](http://www.cmts.ca).

### October 4–6—AGMA Steel for Gear Applications

Alexandria, VA. This course provides detailed information to make use of steel properties in a system solution and understand the potential that different steel options can offer for various applications. Students will explore the how the production of the steel can affect the performance of the material and also the final component and system. The course will be facilitated by Lily Kamjou, a senior specialist in Ovako's Industry Solutions Development department. It is an advanced level course and qualifies for those individuals pursuing the Advanced Gear Engineering Certificate. For more information, visit [www.agma.org](http://www.agma.org).

### October 24–26—Gear Expo 2017

Columbus, Ohio. For three days, the full range of drive technology experts—design, manufacturing, application engineering, gear buyers and manufacturers—network and build relationships that benefit their respective companies. For the past six years, AGMA's Gear Expo has been growing and expanding with more suppliers and attendees meeting to build new partnerships and explore the latest technology on the market. Attendees represent a variety of industries including off-highway, industrial applications, automotive, and oil and gas as well as aerospace, agriculture and construction. They come from around the United States, international manufacturing hubs, and emerging markets to conduct profitable business transactions and collaborate on the innovations that make their operations more streamlined. The show is co-located with the ASM Heat Treating Society Conference and Exposition. For more information, visit [www.gearexpo.com](http://www.gearexpo.com).

## CALL FOR PAPERS!

Are you sitting on an idea for a technical paper but wondering where to present it? Do you have one already written, sitting on your desk, gathering machine dust?

How about *Power Transmission Engineering*? We are always looking for gearing- and power transmission component-relevant technical papers for publication in the magazine and in its digital version. Having your work appear in *Power Transmission Engineering* guarantees you an audience of the most experienced and discriminating industry players. You say your work has not been peer-reviewed? Not a problem, as we are lucky—and thankful—to have on-hand some of the most experienced and brilliant minds in the industry—our technical editors. So if your work “passes muster” and is published, you’ll know you were reviewed by the best—and most demanding.

Chances are you’ll be creating the paper under the auspices of the company for whom you work or own, or for one of the various industry-relevant associations. That means they as well will bask in the reflected glory that accrues with publication in *Power Transmission Engineering*.

For publication guidelines and more information, please contact Jack McGuinn at [jmcguinn@powertransmission.com](mailto:jmcguinn@powertransmission.com).

### AGMA

Page 9  
[www.gearexpo.com](http://www.gearexpo.com)

### Andantex USA Inc.

Page 13  
[www.andantex.com](http://www.andantex.com)

### B&R Machine and Gear

Page 32  
[www.brgear.com](http://www.brgear.com)

### Baldor

Page 3  
[www.baldor.com](http://www.baldor.com)

### Beyta Gear Service

Page 53  
[www.beytagear.com](http://www.beytagear.com)

### Brother International

Inside Front Cover  
[www.brothergearmotors.com](http://www.brothergearmotors.com)

### C-Flex Bearing Company

Page 2  
[C-Flex.com](http://C-Flex.com)

### Circle Gear

Page 11  
[www.circlegear.com](http://www.circlegear.com)

### CTI Symposium China

Page 35  
[www.transmission-symposium.com/china](http://www.transmission-symposium.com/china)

### Designatronics

Page 7  
[www.sdp-si.com](http://www.sdp-si.com)

### Diequa Corp.

Pages 27, 33  
[www.diequa.com](http://www.diequa.com)

### Forest City Gear

Page 17  
[www.forestcitygear.com](http://www.forestcitygear.com)

### Gear Expo

Page 9  
[www.gearexpo.com](http://www.gearexpo.com)

### Hannover Milano Fairs

Page 19  
[www.ptc-asia.com](http://www.ptc-asia.com)

### Lafert North America

Page 14  
[www.lafertna.com](http://www.lafertna.com)

### Mach III Clutch

Page 16  
[machiii.com](http://machiii.com)

### McInnes Rolled Rings

Page 10  
[www.mcinnesorledrings.com](http://www.mcinnesorledrings.com)

### Molon Motor and Coil

Page 18  
[www.molon.com](http://www.molon.com)

### Napoleon Engineering Services

Page 25  
[www.nesbearings.com](http://www.nesbearings.com)

### Nordex Inc.

Pages 12, 32  
[www.nordex.com](http://www.nordex.com)

### QA1 Precision Products

Page 55  
[www.qa1.net](http://www.qa1.net)

### R+W America

Page 15  
[www.rw-america.com](http://www.rw-america.com)

### Rocky Mountain Technologies

Page 53  
[www.rockymountaintechnologies.com](http://www.rockymountaintechnologies.com)

### Schaeffler Group

Back Outside Cover  
[www.schaeffler.us](http://www.schaeffler.us)

### SEW-Eurodrive

Inside Back Cover  
[www.seweurodrive.com](http://www.seweurodrive.com)

### SDP/SI

Page 7  
[www.sdp-si.com](http://www.sdp-si.com)

### SMT

Page 2  
[masta.smartmt.com](http://masta.smartmt.com)

### Suhner Manufacturing

Page 55  
[www.suhner.com](http://www.suhner.com)

### Turner Uni-Drive

Page 32  
[www.turnerunidrive.com](http://www.turnerunidrive.com)

### Zero-Max

Page 5  
[www.zero-max.com](http://www.zero-max.com)



# Power Transmission Engineering



**Power Transmission Engineering** is Your KEY to understanding Gears, Gear Drives, Bearings, Motors, Clutches, Couplings, Brakes, and other Power Transmission Components.

Unlock your FREE subscription by filling out this form.

## FREE SUBSCRIPTION

**1**  **YES** I want to receive/continue to receive **Power Transmission Engineering** FREE!  
 No thank you.

Name: \_\_\_\_\_ JobTitle/Position: \_\_\_\_\_  
(print)

Signature \_\_\_\_\_ Date: \_\_\_\_\_  
(required)

**2** → E-mail \_\_\_\_\_  
(So we can notify you when the online edition is available)

 **SAVE a TREE!**  
 I ONLY want the digital edition (e-mail required)

**3** → Please update your contact information or attach you business card here. (No Staples)

Company Name: \_\_\_\_\_  
 Address: \_\_\_\_\_  
 \_\_\_\_\_  
 \_\_\_\_\_  
 City: \_\_\_\_\_  
 State/Province: \_\_\_\_\_ ZIP+4/Postal Code: \_\_\_\_\_  
 Country: \_\_\_\_\_  
 Telephone: \_\_\_\_\_ Fax: \_\_\_\_\_  
 E-mail: \_\_\_\_\_  
 Website: \_\_\_\_\_

**5** → My company's principal product or service is: \_\_\_\_\_

**6** → What is your primary job function responsibility? (Check one)

<input type="checkbox"/> Corporate Management (1)	<input type="checkbox"/> Quality Control (7)
<input type="checkbox"/> Plant Engineering (2)	<input type="checkbox"/> Factory Automation (8)
<input type="checkbox"/> Design Engineering (3)	<input type="checkbox"/> Maintenance (9)
<input type="checkbox"/> Marketing & Sales (4)	<input type="checkbox"/> Other (10)
<input type="checkbox"/> Manufacturing Engineering (5)	
<input type="checkbox"/> Purchasing (6)	

Is there a colleague within your company that might benefit from having their own copy of **Power Transmission Engineering** magazine?

Name: \_\_\_\_\_  
 Title: \_\_\_\_\_

**4** → How is THIS LOCATION involved with power transmission products? (Check all that apply)

WE MAKE power transmission products (10)  
 WE BUY power transmission products (12)  
 WE SELL power transmission products (Distributors, sales reps. etc.) (14)  
 WE DESIGN products with power transmission components in them. (16)  
 Other (please describe) (15) \_\_\_\_\_

**DIGITAL SUBSCRIPTIONS**

**YES, I want to be notified each issue when *Power Transmission Engineering* is available online**

**YES, I would like to receive *Power Transmission Engineering's* monthly e-mail newsletter**

**YES, I would like to receive *Power Transmission Engineering's* twice monthly e-mail Product Alerts**

**YES, I would like to receive 3rd-party e-mails from *Power Transmission Engineering's* advertisers and partners**

**YES, I would like to receive subscription renewal notices by e-mail**

**No, I do not wish to be contacted by e-mail.**

**FAX TO 1-847-437-6618** or  
 VISIT US ONLINE AT  
[www.powertransmission.com/subscribe.htm](http://www.powertransmission.com/subscribe.htm)

# MediaMation Utilizes Digitization and Pneumatics to Alter Theater Experience

Matthew Jaster, Senior Editor

**“For your safety, please keep your hands, arms and legs inside the vehicle at all times.”**

We’ve heard this statement countless times at amusement parks, but we may start hearing it at the local multiplex (which sounds rather difficult when you’re gripping a large bucket of popcorn and a gallon of soda).

Imagine a car chase in your typical big-budget summer spectacular, but instead of watching the action unfold, the audience is participating in it.

On a hairpin turn, the cinema seats tilt to the left — only to swing back to the right when the car is travelling straight ahead again. The audience can feel the unevenness of the road surface, smell the fragrant undertones of burning rubber and take in exhaust fumes. Water splashes into their faces as the car drives through a puddle. At the same time, they can feel a draft of air blowing through their hair.

This is the concept behind MediaMation’s MX4D Motion EFX seats. With these premium theater seats, the audience essentially goes along for the ride. Festo, a supplier of pneumatic and electrical automation technology, assists in the process.

Jeremy Shubert, sales engineer at Festo, says the company has enabled the MX4D cinemas to run reliably for years for various entertainment enterprises. “The addition of the Festo Motion Terminal reduces the total air consumption as well as provides diagnostics and reduces control complexity,” Shubert said.

The Festo Motion Terminal VTEM controls all kinds of motion and triggers all the effects. This versatile pneumatic control system integrates digital functions into a single valve. Preprogrammed function modules and motion apps eliminate the need for costly system structures. The motion apps “Proportional directional control valve” and “Proportional pressure regulation” control the flow rates and pressures to ensure fast and powerful yet gentle and precise motion sequences.

So the car chase unfolds in a much more realistic (and terrifying) way on the screen in front of you.

“Controlling dynamic vertical loads with pneumatics is a challenging task that the Motion Terminal makes easier,” Shubert said. “Components such as the SDAP position transmitter that mounts directly into the actuator slot provides robust feedback of the actuator position.”

This is all possible with the latest advancements in digitalization and piezo technology. Each individual film sequence gets its own preset controls and operation, giving the audience a fast and intuitive viewing experience.



The motion profiles for the films are processed in a controller CPX-CEC directly on the Festo Motion Terminal. Many hardware components previously required are now superfluous. With the VTEM, three valves control the three actuators of each cinema seat, while one valve is responsible for pressure regulation.

“The Festo Motion Terminal makes everything much easier for us. Installation, commissioning, diagnostics and fault-finding can now be realized with far fewer components,” said Dan Jamele, CEO of MediaMation.

And it’s also getting some “theater to arena” activity in the gaming industry.

MediaMation has partnered with Hammer Esports and TCL Hollywood Chinese Theatre to enhance the gaming theater concept. The modular system allows theaters to transform seamlessly into esports arenas, with tournaments organized and hosted by Hollywood Esports.

Featuring the MX4D motion EFX seats, participants can immerse themselves in the full schedule of game play and competitions. A GameMaster/DJ will synchronize the seating with the game play, so that spectators get to experience the motion and intensity of the game itself. This concept was recently featured at the Electronics Entertainment Expo (E3) in Los Angeles.

Festo is proud to be involved in technology that is altering the entertainment industry.

“The Motion Terminal essentially enables a company like MediaMation to continue to push theater design into the future,” Shubert added.

And potentially make your Sunday afternoon matinee five times as thrilling.

For more information, visit [www.mediamation.com](http://www.mediamation.com) or [www.festo.com](http://www.festo.com). **PTE**



## The key to productivity...

Stop wasting valuable time on the phone or fumbling through catalogs, price books and emails to specify a gear unit for your application. Simply go online to the PT Pilot® selection tool from SEW-EURODRIVE!

PT Pilot® quickly provides quotes, parts lists, 3D CAD drawings, motor options, gear options and variable frequency drives with just a few keystrokes.

It is also compatible with smartphones and tablets. So, you can literally obtain an immediate quote at your fingertips anytime, anywhere!

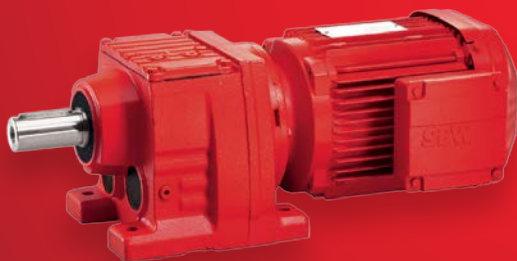
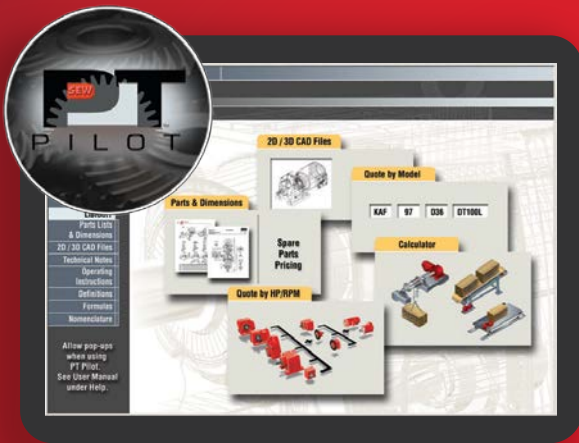

**SCHAEFFLER**

**X-life**  
proven to be better

# Stop Downtime from Bottling Up Your Profits!

## Uncork Some Schaeffler Reliability with KUBE

Schaeffler's innovative 4-row linear recirculating ball bearing and guideway system, KUBE is designed to keep your packaging machines moving by effectively vanquishing those dreaded causes of downtime: inadequate lubrication and contamination. Featuring our exclusive X-life™ technology, KUBE is synonymous with extra-long maintenance intervals and maximum productivity.

### SUPERIOR LUBRICATION • OPTIMUM SEALING

With an integrated, patented lubrication channel in the carriage's load zone that stores grease where it's needed and an innovative one-way lubrication valve that ensures consistent grease flow, **KUBE delivers longer lubrication intervals than any competitor's bearings on the market.** Meanwhile, advanced, low-friction seals offer optimum protection against contamination with minimal displacement resistance.

Choose KUBE and bottle up downtime, not your profits!

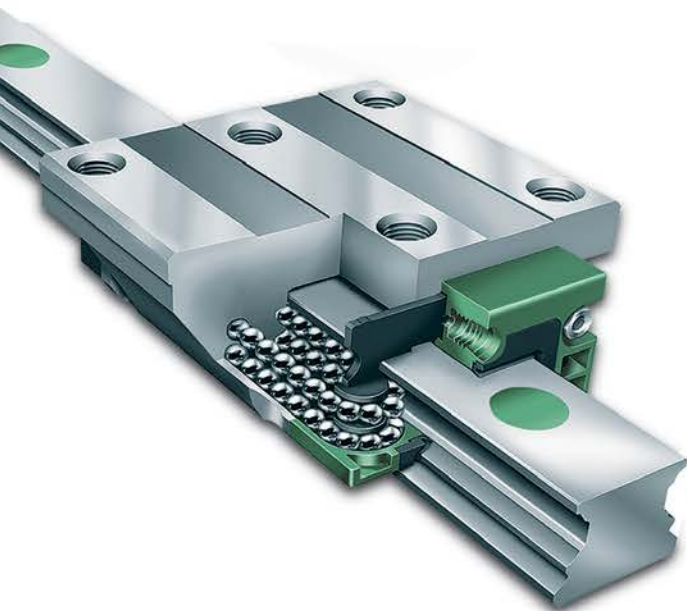

Need more details?  
Please contact us at [info.us@schaeffler.com](mailto:info.us@schaeffler.com)  
[www.schaeffler.us](http://www.schaeffler.us)

©2016

Superior-quality products.  
Comprehensive reliable solutions.

