

Power Transmission Engineering®

JUNE 2021

OFF-HIGHWAY

GEAR DRIVES • FLUID POWER • BEARINGS



Power Transmission Engineering is now published by The American Gear Manufacturers Association

www.powertransmission.com



You could always rely on your brother for the best protection.

You still can. With Brother Gearmotor's industry-best 5-year limited warranty, you can be assured of the best protection and performance on every standard model.



With premium protection comes the ultimate peace of mind. That's why Brother leads the way once again, by shielding its entire line of standard gearmotors with the industry's best warranty. No matter how far the journey or how rough the path, rest assured you've got the protection you need right at your side. Brother...we've got your back.



Call us today for a sample gearmotor to try out.

brother
at your side

866.523.6283
BrotherGearmotors.com

Power Transmission Engineering®

JUNE 2021



A Publication of
The American Gear
Manufacturers Association



FEATURE ARTICLES

- [22] **The Power Shift**
Companies look to fuel economy, energy efficiency and operating costs to improve off-highway applications.
- [28] **Electric Car Safety**
Freudenberg provides DIAvent pressure equalization element for Chinese passenger cars.
- [32] **Simple, but Tough**
Radial spherical plain bearings play a key role in off highway equipment and vehicles.

TECHNICAL ARTICLES

- [44] **Field Weakening**
What, how, and why to do it.
- [48] **Joint Research and Simulation Software for an Optimized Rolling Bearing Friction Model**
FVA Software bundles the results and knowledge from hundreds of research projects in one platform.
- [52] **CASE STUDY: Smart Electric Actuators Give the Marching Arts a Lift**
Electric actuators are demonstrating logistics efficiencies and improvements that have numerous implications.

Stay Connected



Follow us on Twitter
twitter.com/#!/PowerTransMag



Connect with us on LinkedIn
www.linkedin.com/groups/Power-Transmission-Engineering-PTE-2950055



Subscribe Online
www.powertransmission.com/subscribe.htm

Vol. 15, No. 4. POWER TRANSMISSION ENGINEERING (ISSN 2331-2483) is published monthly except in January, May, July and November by The American Gear Manufacturers Association, 1840 Jarvis Ave., Elk Grove Village, IL 60007, (847) 437-6604. Cover price \$7.00. U.S.

Periodicals Postage Paid at Elk Grove Village IL and at additional mailing offices. Send address changes to POWER TRANSMISSION ENGINEERING, 1840 Jarvis Ave., Elk Grove Village, IL 60007.

The American Gear Manufacturers Association makes every effort to ensure that the processes described in POWER TRANSMISSION ENGINEERING conform to sound engineering practice. Neither the authors nor the publisher can be held responsible for injuries sustained while following the procedures described. Postmaster: Send address changes to POWER TRANSMISSION ENGINEERING, 1840 Jarvis Avenue, Elk Grove Village, IL, 60007. ©2020 Contents copyrighted by THE AMERICAN GEAR MANUFACTURERS ASSOCIATION. No part of this publication may be reproduced or transmitted in any form or by any means, electronic or mechanical, including photocopying, recording, or by any information storage and retrieval system, without permission in writing from the publisher. Contents of ads are subject to Publisher's approval.

FIND OUT MORE NOW AT:
WWW.NEUGART.COM/EN-US



POWERFUL SOLUTIONS FOR RACK AND PINION DRIVES.

Planetary gearboxes with mounted pinion

A gearbox/pinion combination developed from a single source is the guarantee of ideal technical coordination for your rack and pinion drive.

CONTACT:
Neugart USA Corp. | 14325 South Lakes Drive
Charlotte, NC 28273 | USA
Phone: +1 980 299-9800 | sales@neugartusa.com



QuickSilver Controls SilverMax™ Integrated Hybrid Servos

Motor + Encoder + Controller + Driver

High Efficiency Over Wide Speed Range
Highly Programmable
Handles Large Inertia Mismatch
NEMA 23 and 34

Bringing Our 23 years of
Hybrid Servo Expertise
to Your Project!





+1 909 599 6291

www.QuickSilverControls.com

Power Transmission Engineering

VOL. 15, NO. 4

- [04] **PTEExtras**
Hannover Messe Digital Recap; **PTE Videos:** Dana Spicer TE50; **NSK** Mining and Construction Success Story.
- [06] **Publisher's Page**
Getting Ready for Normal.
- [08] **Product News**
Ringfeder Couplings Offer Concentricity for Precision Applications; **SDP/SI** Introduces New Brushless Motors and Motion Control Solutions; **Schaeffler** Presents LubeAdvisor Mobile App; **Voith** Presents Drivetrain Diagnostics System; **SKF** Updates Bearings App; **Siemens** Introduces Sinamics G115D Distributed Drive System; **Faulhaber** Miniature Motion Controllers Offer Compact Design and Custom Options; **Bonfiglioli** Offers Drive Diagnostic App.
- [40] **Engineering sMART**
Products and services marketplace.
- [56] **Industry News**
News and highlights from around the industry.
- [62] **Advertiser Index**
Contact information for every advertiser in this issue.
- [63] **Subscriptions**
Renew your free subscription today.
- [64] **Power Play**
History-Making Micromotors on Mars!





Aggregate motors

For the toughest conditions

We understand that harsh and rugged environments require exceptional designs and features. If you have specific needs around **torque, service factor, overload**, inverter use, or dust ratings, we have quarry duty, severe duty, crusher duty, and custom solutions. Stock ABB and Baldor-Reliance® aggregate motors are now available in 184T through 588 frames.

Reliable. Flexible. Performance.

479-646-4711
new.abb.com/motors-generators

ABB

Hannover Messe Digital Recap

Robotics, digital tools, automation and artificial intelligence will all play a significant role in the factory of the future. Companies like Continental, ALD Vacuum Technologies, Schaeffler, and Bosch Rexroth are using technology to advance PT and motion control components. Learn more here:

www.powertransmission.com/blog/hannover-messe-2021-smart-manufacturing/



PTE Videos Dana Spicer TE50

The Dana Spicer TE50 powershift transmission is designed for large load haul dumpers, trucks used in underground mining, as well as wheel loaders. The Spicer TE50 transmission is engineered to fit within current vehicle design envelopes and is offered with a four- or eight-speed gearbox that provides optimized shifting ratios. It is available with advanced automatic lockup, which improves fuel efficiency by enabling direct drive even at low speeds.

www.powertransmission.com/videos/Dana-Spicer-TE50/

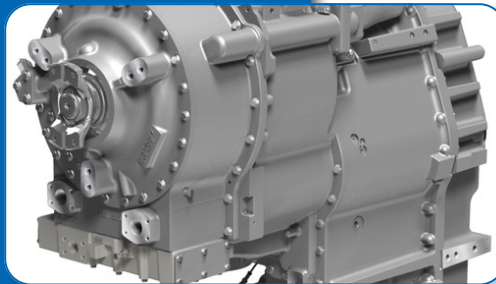

NSK Mining and Construction Success Story

A customer was experiencing constant bearing failure within an autoclave bogie wheel assembly, using deep groove ball bearings. The failures resulted in damage of surrounding hardware (housings and axles) and high labor and parts cost, as components needed frequent replacement. NSK Engineers examined the application and determined that ingress of hard particulates and moisture, combined with excessive load was the root cause of premature bearing failure.

www.powertransmission.com/videos/NSK-Mining-and-Construction-Success-Story-/



Power Transmission Engineering



AGMA MEDIA
1840 Jarvis Avenue
Elk Grove Village, IL 60007
Phone: (847) 437-6604
Fax: (847) 437-6618

EDITORIAL

Publisher & Editor-in-Chief
Randy Stott
stott@agma.org

Senior Editor
Jack McGuinn
m McGuinn@agma.org

Senior Editor
Matthew Jaster
jaster@agma.org

ART

Art Director
David Ropinski
ropinski@agma.org

ADVERTISING

Advertising Sales Manager & Associate Publisher
Dave Friedman
friedman@agma.org

Materials Coordinator
Dorothy Fiandaca
fiandaca@agma.org

CIRCULATION

Circulation Manager
Carol Tratar
tratar@agma.org

ACCOUNTING
Luann Harrold
harrold@agma.org

MANAGEMENT

President
Matthew Croson
croson@agma.org

FOUNDER

Michael Goldstein founded Gear Technology in 1984 and Power Transmission Engineering in 2007, and he served as Publisher and Editor-in-Chief from 1984 through 2019. Michael continues working with both magazines in a consulting role and can be reached via e-mail at michael@gartechtechnology.com.



EXTREME ENVIRONMENTS CALL FOR RESILIENT & RELIABLE MOUNTED SPHERICAL UNITS.

Harsh environments need a resilient and reliable spherical roller bearing housed unit that can stand up to tough conditions. RBI Bearing's line of Mounted Spherical Units are designed to withstand challenging environmental conditions, such as, impacts from aggregate, extreme temperatures, heavy load conditions and misalignment. Available with Armor Bearing Technology & Protection to reduce bearing friction and substantially increase bearing life. Contact RBI Bearing for pricing.

www.rbibearing.com 1-800-708-2128

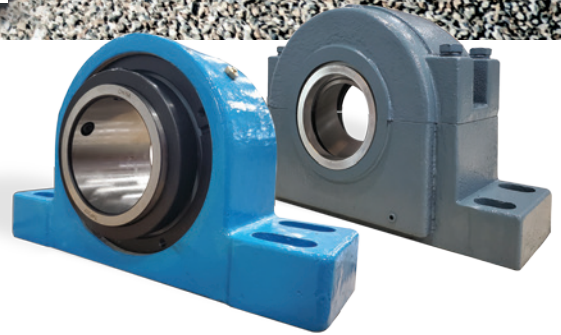

Getting Ready for Normal



In May, Gov. Mike Parson of Missouri sat down and recorded a video on behalf of AGMA's upcoming Motion+Power Technology Expo. He wanted to personally invite as many people as possible to come to the show, recognizing its importance as one of the first and most significant manufacturing shows being held in person this year. You can watch Governor Parson's full video here: https://youtu.be/wlzLNMA_B00.

"Manufacturing is extremely important to Missouri," Parson says, "We are pleased to welcome those in the gear, electric and fluid power industries to come to do business in our innovative and technology-advanced state."

MPT Expo takes place Sept. 14-16 in St. Louis, and it will feature exhibitors from the entire supply chain for the power transmission industry. So if you're looking for a new supplier of gears, gear drives or other mechanical, electrical or fluid



"We're ALL IN for the Motion + Power Technology Expo, and we are open for business."

– Governor Mike Parson of Missouri

power transmission components, you'll find many of our industry's leading suppliers there. And if you are a manufacturer of those components, you'll find the full range of machine tools, cutting tools, inspection equipment, materials and services needed to make gears and gear drives – not to mention the fact that the show is co-located with ASM's Heat Treat 2021, where you'll find everything you need for heat treating.

More than 130 exhibitors have signed up to participate in the show, and more are expected as companies loosen restrictions on travel over the summer. You can see the full list at motionpowerexpo.com.

It's extremely rare in the industrial trade show world for such a high-profile individual to take an active role in promoting a single event. That's how important MPT Expo is.

"We are ready to welcome you," Parson says. "Exhibitors and attendees will be able to safely meet face to face at an event that moves the power transmission industry forward."

Like Governor Parson, we at *Power Transmission Engineering* are also looking forward to MPT Expo. It's been a long time since we've gotten to see many of our advertisers and subscribers in person, and the AGMA Media team is ready to help our industry return to some semblance of normalcy. In fact, we're thrilled to be able to go to St. Louis and report on the latest developments, trends and technologies in our industry.

We'll have pre-show coverage of MPT Expo beginning next issue, and we'll continue that coverage in our September show issue. While we're in St. Louis, our editors will be interviewing as many experts as possible, and the results of those conversations will appear as articles in print, online and even in video segments for the *Revolutions* series on *Power Transmission Engineering TV*.

Registration for MPT Expo is now open. In fact, our team would like to offer you the opportunity to join us as our guest. We understand there are unique factors to consider this year, including health and safety protocols during live events, travel budget restrictions and more. The last thing you need to worry about is paying another entry fee.

That is why we're happy to offer this discount code for a free Expo Only pass (available until the end of June): **MPTFREE**.

I hope you'll join us in St. Louis. We're really looking forward to seeing you all again.

Randy Stott

We deliver precision gears, high-quality machined parts, and molded components for thousands of applications.

- Prototype
- High-Volume Production
- Custom Design
- Engineering Support
- Precision Manufacturing
- Assembly



ISO 9001:2015 | AS9100D
ITAR Compliant - DDTC Registered
DFARS Compliant
NIST SP 800-171 Compliant

CNC Swiss Turning | CNC Milling & Turning | Gear Cutting | Bevel Gear Cutting
Rapid Tooth Cutting Only Capability



As an online engineering resource, SDP/SI provides:
Engineered Mechanical Solutions
Design Tools and Calculations
Product Specifications
3D CAD Models

Shop with us 24/7
87,000 Component Choices
Gears, Timing Belts, Pulleys, Couplings, and More

SDP/SI looks forward to working with you!
Send an RFQ – we can quote from a
3D model or drawing

For Metric Gears or Bearings, Check into our sister companies:



Supplying North America
with Metric Gears

<https://qtcgears.com>



The Bearing Marketplace

<https://qbcbearings.com>

Ringfeder

COUPLINGS OFFER CONCENTRICITY FOR PRECISION APPLICATIONS

Ringfeder Power Transmission recently released its GWE 5113 and 5117 series of elastomer jaw couplings which include a compact hub design, low moment of inertia and excellent damping properties. Thanks to this combination of features, these new couplings are ideal for linear technology, robotics, conveyor systems and other precision-driven applications.

Featuring two single-slit clamping hubs made of high-strength aluminum, the 5113 model facilitates installation, while its symmetrical clamping slots and screw positions ensure an even distribution of mass. With this optimized design, the coupling offers superior concentricity and eliminates any radial loads that can damage the bearings of the motor shaft. This hub design is also featured in the 5117 model, which includes an expanding mandrel for friction-locked torque transmission on hollow shafts.

Other features and benefits of the 5113 and 5117 models include:

- Low mass and an even weight distribution due to their special aluminum hub.
- Superior concentricity and uniform



vibration- and shock-damping power transmission, owing to the symmetrical arrangement of the clamping slots and screw positions, as well as the un-slotted cam area.

Compact design, making units ideal for small or confined installation spaces.

Precise, backlash-free torque transmission up to 560 Newton meters.

Seven available sizes with wide bore diameters from 4 to 56 millimeters.

Adjustable misalignment capabilities, damping properties and torsional stiffness levels, thanks to bored and unbored elastomer spiders that range in Shore hardness levels from 80 Shore

A to 64 Shore D.

Optional coupling hubs with keyways to DIN 6885-1 or standard inch dimensions.

Laser marking for easy traceability. These markings include the coupling type designation, manufacturing date and screw-tightening torques.

Optional ATEX compliance for explosive areas.

In addition, Ringfeder has applied QR codes to these couplings starting from size 19, providing users with quick, convenient access to assembly and operating instructions via a mobile device.

www.ringfeder.com



SDP/SI

INTRODUCES NEW BRUSHLESS MOTORS AND MOTION CONTROL SOLUTIONS

Stock Drive Products/Sterling Instrument (SDP/SI) is launching a series of brushless DC servomotors, AGV motors, controllers, and integrated motors.

Whether it is a 600 kg or 1,200 kg AGV application that demands substantial torque or a compact solution for precision automation application the brushless DC motors (BLDC) are designed to meet a range of requirements. The 24V and 48V motors are rugged IP rated, quiet, and highly efficient. For demanding applications where rapid acceleration and deceleration is needed, SDP/SI now offers two premium brushless servomotor series. These provide an all-in-one



90 MISSILES

330 SAILORS

1,100 MILES OUT
TO SEA

**ZERO
ROOM
FOR GEAR
DRIVE
FAILURE.**



Whether it's the frontline combat fleet of the U.S. Navy or your own gear drive operation needs, Philadelphia Gear delivers mission-critical performance and reliable, responsive support.

With unmatched expertise that's on call 24/7, plus complete warranty coverage on workmanship and material for any gear drive we service, including those from other manufacturers, we've set the standard in dependability — on land and at sea — for more than 125 years.

Keep your mission moving.

Visit [PhilaGear.com/MyMission](https://www.philagear.com/MyMission) to learn more.

solution, offered in 5 frame sizes, rated speeds up to 6,000rpm, with brake, gearhead, and feedback options they are used in systems requiring reliability, high torque density, and low noise. Integrating the brushless servomotor is now even easier with the user-friendly motion controller software interface combined with low, mid, and high-power controllers offered in single or dual channel configurations. To cover any system requirements SDP/SI also presents a wide range of AGV

accessories: such as optical flow sensor, magnetic track following sensor, and controller network communication options.

“SDP/SI offers custom design, manufacturing and a wide variety of component choices for the engineer and OEM,” said Robert Kufner, president and CEO of Designatronics, Inc. “The addition of these motors with brushless technology, speed and torque flexibility provides our customers with a reliable, cost-effective servo control

solution. As applications change and industries evolve we will continue to provide products that suit our customer’s needs and the engineering expertise to set their ideas into motion.”

“SDP/SI continues to develop and supply components and custom engineered solutions that improve productivity and quality for our customers,” said Doug Kerester, vice president of sales and marketing, Designatronics. “The brushless servomotors are the latest addition to our catalog designed to offer a diverse line of products with a wide range of available options.”

www.sdp-si.com



Your Objective:

One face in perfect alignment with another. *For infinity.*

No problems. No distress. No delays.

That’s the same objective you have for choosing your gear producer. Circle Gear’s objective is to engage with every customer’s objectives.

- ▶ **One to 1000 gears**
- ▶ **Customer designed or reverse engineered**
- ▶ **Gearbox repair, rebuild or redesign**
- ▶ **OEM or end-users**
- ▶ **ISO 9001:2015 Certified**

1501 S. 55th Court, Cicero, IL 60804
 (800) 637-9335
 (708) 652-1000 / Fax: (708) 652-1100
sales@circlegear.com
www.circlegear.com



Spiral and Straight Bevel Gears (*Cut, Ground or Lapped*) • Spur Gears • Helical Gears • Long Shafts • Herringbone Gears • Involute and Straight Sided Splines • Internal Gears • Worm and Worm Gears • Racks • Sprockets • ISO Certified



Partnering with QualityReducer to provide Gearbox repair, rebuilding and reverse-engineering.

Schaeffler

PRESENTS LUBEADVISOR MOBILE APP

The new LubeAdvisor mobile app helps ensure optimal bearing lubrication. Designed for iOS and Android mobile devices, LubeAdvisor quickly and accurately calculates the optimal lubrication amount and interval for bearings.

Developed by the engineering experts at Schaeffler, LubeAdvisor has



been designed to take the guesswork out of bearing lubrication using the smartphone-based convenience customers have come to expect.

Available free in the App Store and on Google Play, it offers an intuitive interface and simple-to-perform calculations. Using LubeAdvisor is quick & easy:

1. Select the appropriate bearing number and grease type from the app's dropdown menus.
2. Enter the applicable operating parameters.
3. LubeAdvisor instantly calculates the optimal lubrication quantity and time interval for the selected bearing.

LubeAdvisor helps keep bearings operating at peak performance with just a few clicks on any iOS or Android mobile device.

www.schaeffler.com

Atlanta Drive Systems

ANNOUNCES NEW RANGE OF STEEL WASHDOWN GEARBOXES

Atlanta Drive Systems, Inc. is pleased to announce a new range of stainless steel washdown gearboxes, perfect for use in demanding applications in the food and beverage, meat and poultry, marine, chemical and pharmaceutical industries. They are ideal for applications that have direct contact with food

products which require washdown under high pressure and are available with ATEX and IP69k protection.

They are offered in three levels of corrosion protection depending on the environment they are exposed to: Coated Aluminum (Z-Series), Stainless Steel Shielded (L-Series) and Stainless



SMT

Gearbox & Driveline Design, Analysis & Optimisation

MASTA enables engineers to design robust, efficient, light weight and quiet transmissions from concept design, all the way through to manufacture.

Run and generate reports on a wide variety of analyses including NVH, system deflection, durability, FE & more.

Visit smartmt.com/masta to learn more.

MASTA¹¹

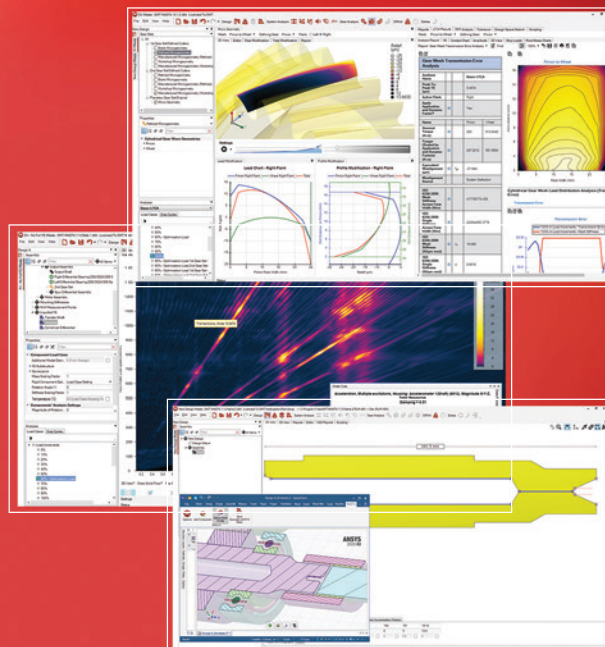

Visit smartmt.com/evaluation-PTE to request a FREE evaluation of MASTA for up to 3 months.

Steel (I-Series).

The gearboxes are available in reduction ratios from 5:1 to 102:1, with output torque capacities up to 480 lb.ft. and input powers up to 5.4hp. Stainless steel motors are also available for use with these gearboxes.

Unit design benefits include: housings with smooth surfaces, stainless steel 316L output shafts, viton seals with stainless steel 316L shield, hardened & ground gearing, all stainless steel 316L hardware, closed stainless steel 316L protection cap with o-ring, and fully modular IEC and NEMA C motor flanges.

www.atlantadrives.com

Voith

PRESENTS DRIVETRAIN DIAGNOSTICS SYSTEM

With OnCare.Health Vorecon, Voith presents a new data diagnostics system that goes one step further than conventional machine protection systems do. It learns, monitors, and performs diagnostics in real time. By means of typical signal patterns, the system first learns the reference state of the machine. Then it continuously monitors, records, analyzes, and evaluates the relevant signals.



With the help of signal and trend analyses, the system predicts the future behavior of the machine. Significant changes are recognized and reported long before an alarm is triggered or a fault occurs. However, if faults do arise, their root causes can be quickly and precisely analyzed and eliminated based on the data.

An easily accessible and user-friendly interface helps the user to keep an eye on all operating data, times, and states of the Vorecon. The user thus receives in-depth knowledge about the machine's behavior under various conditions. From the data in OnCare.Health Vorecon, Voith generates a monthly service report containing extensive performance diagnostics for the machine, including a servicing and maintenance recommendation. This not only ensures optimal stocking of spare parts but also allows service to be scheduled based on the machine state and not according to a fixed cycle. OnCare.Health Vorecon thus helps to increase the availability of the relevant drivetrains and at the same time lowers maintenance costs.

OnCare.Health Vorecon can be easily installed locally and connected via fieldbus to existing IT infrastructures. An

internet connection is not required. Data are also not saved in a cloud. The communication channels meet the highest security standards required for critical infrastructures.

www.voith.com

SKF

UPDATES BEARINGS APP

SKF has updated the app that gives users instant information on super-precision bearings. Super-precision manager app allows users to scan a code on the product packaging, or on the bearing itself, to access product data, mounting instructions and measurement reports. It also includes information on when and where a bearing was manufactured, for enhanced traceability.



The app has been updated with a new bearing matching function which enables each user to retrieve bearing data and combine universally matchable bearings into sets. This choice is critical when for example mounting bearings in spindle applications. The matched sets can be saved into a report for later use or documentation. The function has been added to the app following requests from customers.

“The app makes life easier because it saves time when accessing information,” says Sten Thunberg, project manager at SKF. “It also makes the documentation process much more efficient. There is less chance of human error, because data is not transcribed manually.”

Super-precision manager app is available in 15 languages, including both simplified and traditional Chinese. The app is typically used in machine tool applications, such as spindle repair and maintenance. It can be used in a variety of job functions. Customer service staff can use it to supply detailed documentation, for instance. Similarly, service staff could use the app to see what has been built into a spindle.

Access to this type of information can be further enhanced via SKF's API (application programming interface) portal. The API connects to data—such as product characteristics—in a seamless, secure way. This allows users to build their own technical solutions around tools and machinery. Ultimately, this helps to increase the lifetime of assets and lower costs.

www.skf.com

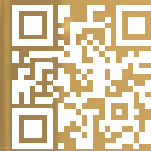
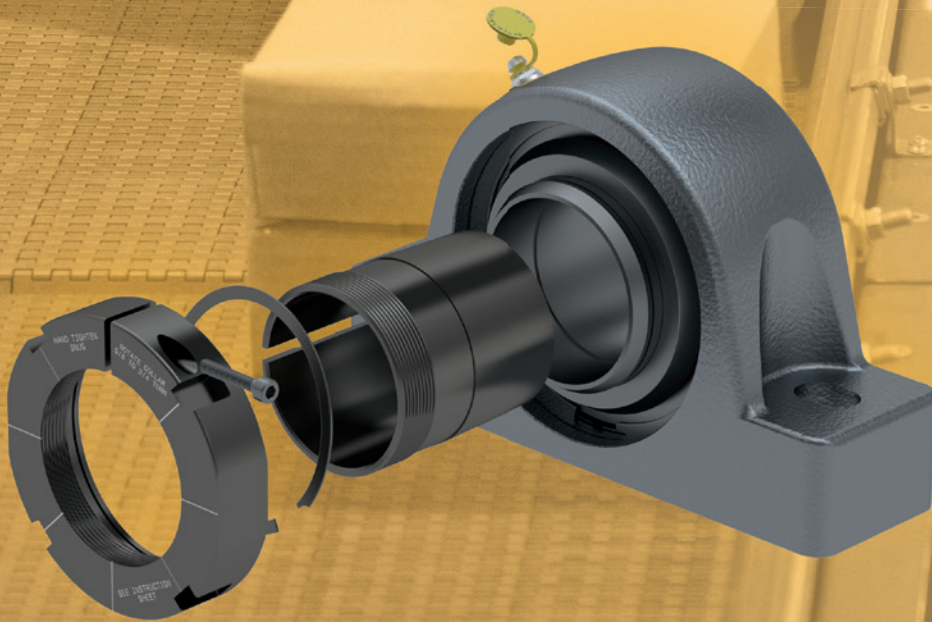

What **if...**

you could
simplify adapter
lock installation?

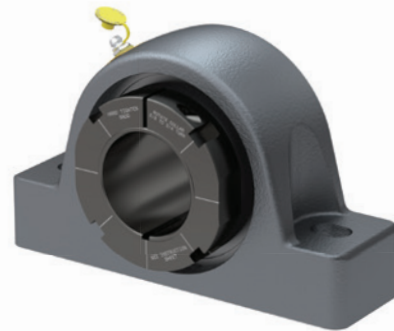

Installation just got easier with the Sealmaster® Klamploc™ adapter lock bearing! With only common tools needed and instructions printed directly on the collar, the patented* Klamploc taper adapter lock reduces complexity and downtime, and improves clamping force compared to standard designs. To contact our experts, visit:

regalbeloit.com/USRB-Klamploc
Creating a better tomorrow™ ...

* Patent #10,422,386

Regal, Creating a better tomorrow, Klamploc and Sealmaster are trademarks of Regal Beloit Corporation or one of its affiliated companies.
© 2020, 2021 Regal Beloit Corporation, All Rights Reserved. MCAD20034E • 10359E

Siemens

INTRODUCES SINAMICS G115D DISTRIBUTED DRIVE SYSTEM

With its new Sinamics G115D, Siemens is introducing a new, compact and powerful drive system specifically designed for horizontal conveyor applications. The drive system comprises the motor, drive and gearbox in one unit and is offered in two versions — wall-mounted and motor-mounted.

The Sinamics G115D drive system is characterized by a robust design with a high IP protection class (up to IP66 / UL Type 4X) and is suitable for use in harsh environments. Thanks to its compact dimensions, the Sinamics G115D can be easily installed in confined areas. The drive system can also be operated reliably over a wide temperature range of -30 to 55 degrees Celsius (-22 to 131 degrees Fahrenheit), enabling operation in deep freezing applications.

Sinamics G115D is suitable for applications in intra-logistics and airports, as well as in the automotive and food and beverage industries. Its power ranges from 0.37 to 7.5 kilowatts (1/2 to 10 hp) for wall-mount applications and 0.37 to 4 kilowatts (1/2 to 5 hp) for motor-mounted applications. The drive system can be put into operation quickly and easily with comprehensive integration into the Totally Integrated Automation (TIA) portal including Startdrive commissioning software or the Sinamics Smart Access Module (SAM) web-server for Wi-Fi setup and diagnostics.

To be prepared for digital transformation and to enable cloud-based analysis, Sinamics G115D is integrated into

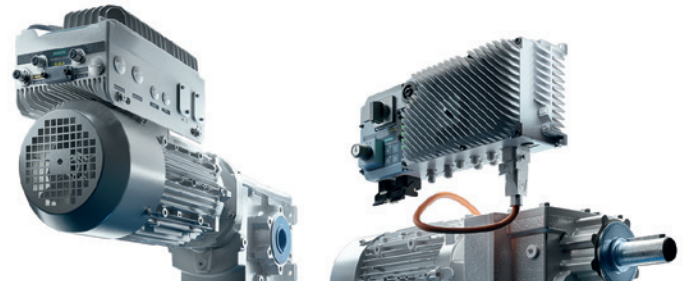

the entire MindConnect portfolio and is compatible with MindSphere applications such as Analyze MyDrives.

Thanks to Profisafe, the Sinamics G115D has Safety Integrated in the form of STO (Safe Torque Off) SIL2, which standardizes and facilitates the certification process. For flexibility in terms of installation, service and maintenance, the solution is equipped with a plug-in connector and flexible connection possibilities. The device is particularly suitable for interaction with Simatic controllers such as the Simatic S7-1200 or Simatic ET200 for motion control.

Siemens offers warranty extensions for Sinamics G115D through its Service Protect package. As part of this service package, an additional one or two-year warranty extension may be purchased for failure coverage. The package offers simplified processing under normal warranty conditions for the extended period.

usa.siemens/sinamics-g115d

A Better Way to Buy Gearboxes

GET STARTED

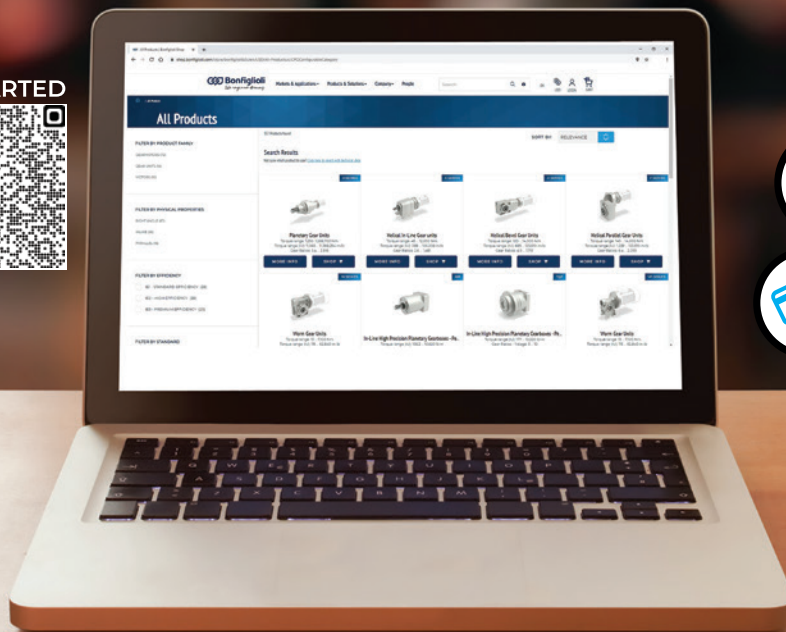

Real-Time Price Estimates



Real-Time Delivery Estimates



Credit Card Payment Accepted

 **Bonfiglioli**

Visit Us at Shop.Bonfiglioli.com

**WE'VE BEEN SOLVING
INDUSTRY'S TOUGHEST
LUBRICATION PROBLEMS
FOR OVER 150 YEARS...**

Roger Thostenson
Lubriplate District Manager
OK, AR, Northern TX & MS



**WHAT CAN WE
DO FOR YOU?**

Lubriplate®

WE ARE HERE TO HELP

Lubriplate has been helping industry meet its lubrication needs for more than 150 years. In that time, we have learned what works and what doesn't. Put our experience and knowledge to work for you.

WE HAVE THE PRODUCTS

Lubriplate offers a full range of ultra high-performance synthetic and petroleum-based lubricants that have been engineered from the ground up to provide a number of cost saving benefits including; extended lubrication intervals, reduced friction, multiple application capability and lubricant inventory consolidation.

WE HAVE THE SERVICES

Lubriplate offers its Complimentary ESP Extra Services Package to all of its customers at no additional charge. Services include; Complete Plant Surveys to help determine your exact lubrication needs, Color Coded Lube Charts and Machinery Tags which simplify maintenance procedures, Lubrication Training Programs and Follow-Up Oil Analysis.

Call 800-733-4755 to get started.



**Lubriplate®
Lubricants**

INCLUDED AT NO ADDITIONAL CHARGE

**Lubriplate's
ESP**

Complimentary Extra Services Package

**COLOR CODED LUBE CHARTS & MACHINERY TAGS
PLANT SURVEYS / TECH SUPPORT / TRAINING
LUBRICATION SOFTWARE / FOLLOW-UP OIL ANALYSIS**

Newark, NJ 07105 / Toledo, OH 43605 / 800-733-4755
To learn more visit us at: www.lubriplate.com



Made in the USA
Used Worldwide

OIL SHEAR
MOTOR BRAKES



No Adjustment-Ever!



Maintenance Free!



FORCE CONTROL
INDUSTRIES, INC

800-829-3244

WWW.FORCE CONTROL.COM

Gates

EXPANDS MEGASYS HYDRAULICS LINEUP

Gates recently introduced the MEGASys MXT with XtraTuff Plus cover (MXT-XTP), a universally applicable hydraulic hose, featuring Gates' patent-pending wire-braid technology. MXT-XTP offers all the benefits of Gates' industry-leading MXT hose—compact size, light weight, flexibility and high performance—with added durability from the company's proven, industry-leading XtraTuff Plus (XTP) cover.

"Gates is known for innovation driven by materials science and process engineering expertise, and pairing that with the voice-of-customer and an ability to anticipate the needs of future applications sets us apart," said Mike Haen, vice president, industrial global product line management. "MXT-XTP maintains the advantageous performance of our popular MXT hose line with the field-proven XtraTuff Plus cover. We continue to revitalize our premium MEGASys hydraulics portfolio by providing solutions for our customers' most challenging applications."

Gates' lightweight, high-performance MXT hose is proven in the factory and field, around the world, being specified in by OEMs and used repeatedly by replacement channels. It's 25 percent lighter weight than conventional hoses, making it easier to lift and handle, plus MXT is up to 49 percent more flexible, allowing faster and more ergonomic installations. Gates has enhanced the MXT hose with the optional XTP cover, maintaining MXT hose performance while adding 25 times the abrasion resistance and enhanced ozone resistance, as validated by a rigorous 800-hour ozone exposure test. The XTP cover was previously

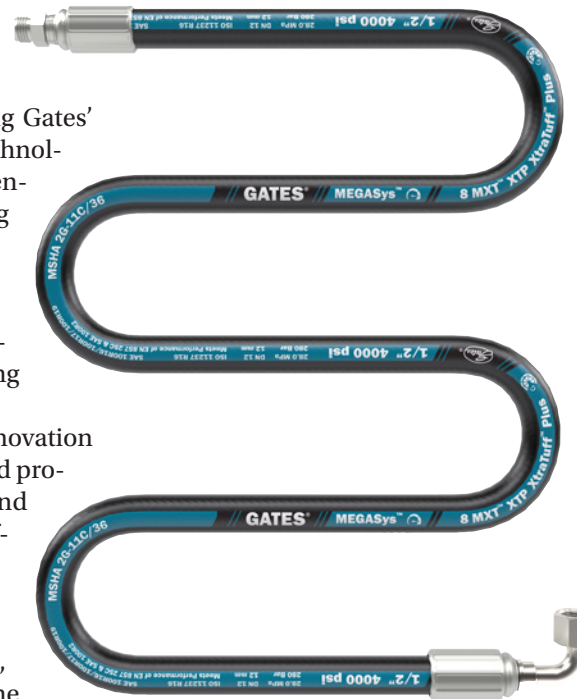

introduced as the standard cover on MXG 4K. MXT-XTP hose meets or exceeds relevant ISO, SAE and EN performance standards, is MHSA-certified for flame resistance, and is certified leak-free per SAE J1754 when used with Gates MegaCrimp couplings.

As a universally applicable premium hydraulic hose, MXT-XTP is suitable for the most demanding fluid power challenges across a broad array of industries and applications, including construction and mining, material handling, machining and metal processing, injection molding and other stationary machinery, agriculture and forestry, aerial lifts and more. Its broad applicability allows customers to simplify and consolidate inventory with a standardized, multi-use hose.

www.gates.com/mxt

NORD

MAXXDRIVE SERIES BUILT FOR TOUGH APPLICATIONS

The MAXXDRIVE portfolio from NORD DRIVESYSTEMS offers parallel and right-angle industrial gear units with high output torques from 132,800–2,301,200 lb-in, ratios from 5.54–30,000:1, and 2.5–8,075 hp across 11 sizes. In addition to this proven standard series, NORD also offers the new MAXXDRIVE XT series; right-angle gear units with thermally-optimized housings, output torques from 132,800–663,800 lb-in, ratios from 6.14–22,91:1, and 30–2,825 hp across 7 sizes. With a comprehensive selection of accessories and options, MAXXDRIVE's modular system allows NORD to perfectly match drive systems to heavy-duty applications such as conveyors, mixers, agitators, or anywhere low speed with high power is needed.

MAXXDRIVE and MAXXDRIVE XT are designed and rated to international standards. Their UNICASE housings optimize the strength-to-weight ratio, reduce leak paths, have higher stiffness, and allow for multiple mounting surfaces. The one-piece housing also ensures that no sealing surfaces are subject to torque. MAXXDRIVE units are constructed with high-grade

components including case-hardened and hardfinished gearing, C4, 42 CrMo4, or 18 CrNiMo7-6 steels, and an exclusive roller bearing system for quiet operation and longer service life. They also have high-precision axis alignment, resulting in smoother operation and reduced maintenance over time. Additionally, all bearing and sealing surfaces are machined in a single process, further promoting low noise and longevity.

Because MAXXDRIVE gear units are engineered based on a modular concept, they allow for a wide range of configuration and mounting options from NORD's standard offering yet can be easily adapted for custom drive applications. For example, the combination of a NORD motor, gear unit, coupling, and braking system results in a complete, precisely-configured unit that can be supplied ready-to-install and pre-mounted on a motor swing base or other base frame. Alternatively, a motor can be attached via industry standard NEMA or IEC adapters. Various flange and output shaft options ensure the customer's application is ideally matched and configurations

are always based on the existing operating data of the application and on the ambient conditions at the installation site, giving customers maximum individualization, and creating reliable, versatile drive systems that meet their highest demands.

www.nord.com

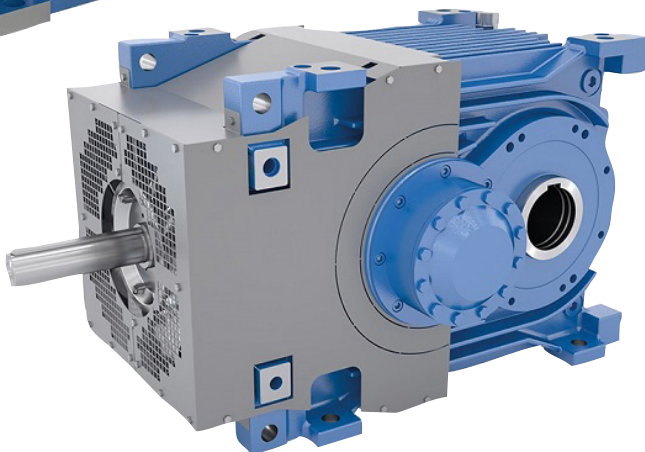
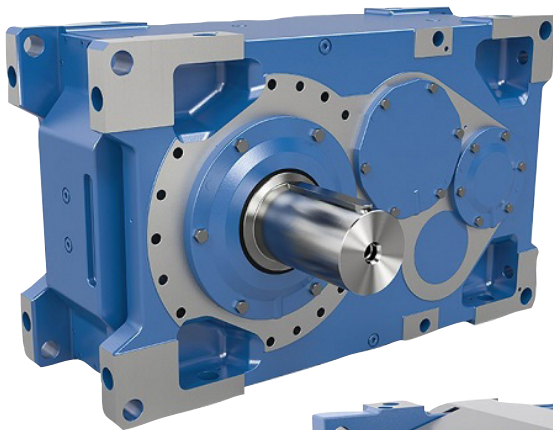

FORGING AHEAD OF THE PACK

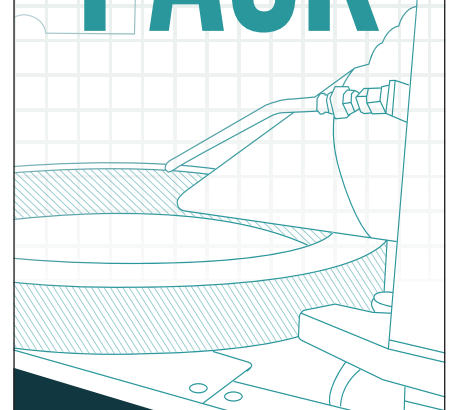

MADE IN THE
USA

**Fast.
No Fine Print.
No Premium.**

At McInnes Rolled Rings, we provide quality products, shipped fast. And we partner that with exceptional customer service to forge the perfect partnership with our customers.

**McINNES
ROLLED RINGS**

1.877.736.4409

www.McInnesRolledRings.com

Faulhaber Miniature Motion Controllers

OFFER COMPACT DESIGN AND CUSTOM OPTIONS

With the new MC3001 motion controllers, available as MC 3001 B (board-to-board connectors) or MC3001P (28-pin plug connector), Faulhaber rounds out the MC V3.0 generation of controllers at the lower end of the performance spectrum. The controllers are extremely miniaturized and, with 1.4 amperes in continuous operation and up to 5 amperes peak current, are very powerful. They are designed as slaves for control and positioning tasks of DC-micromotors, linear DC servomotors or brushless DC-motors.

The new MC 3001 are unpowered versions of the Faulhaber motion controllers and, by means of the integrated output stage with optimized current measurement, can control DC-micromotors, linear DC-servomotors or brushless DC-motors from the Faulhaber product line from 6 to 30 millimeters. They are configured here via the Faulhaber Motion Manager software V6 (version 6.8 and higher). The EMC behavior of the new motion controllers has

been certified by external laboratories.

With an overall height from 2.6 millimeters and a format from 16x27 millimeters, the new motion controllers are



The search is over!

For quality screw jacks that give you all the options in a complete package with the most advanced designs, look no further than DieQua.

- 8 ZE sizes with lifting capacities up to 20 tons
- 3 sizes servo compatible
- Precision machine and ball screws
- Standing and rotating versions
- Multiple spindle end connections and driving nut designs

To finally find what you're looking for, check us out on the web, or give us a call.



ZIMM USA
by **DIEQUA**

screwjacks.com
800-804-8619

extremely miniaturized. They feature very high control dynamics and can be operated with 1.4 amperes in continuous operation and with up to 5 amperes peak current. With the new variants, the company has rounded off its motion controller portfolio at the lower end.

In spite of their extremely compact design, the just thumb-sized controllers feature the same functionality as well as the same interfaces (RS232 and CANopen) and encoder interfaces as the other more powerful products of the MC V3.0 generation. As an intelligent driver module, they are especially well suited for installation in customer-specific applications. The full thermal protection of the motors is ensured with the integrated thermal models and by means of the high PWM frequency.

The ideal fields of use of the new motion controllers of the MC 3001 series are applications from the areas of robotics, automation technology, machine construction as well as medical and laboratory technology. Applications in these areas often have limited space yet call for high control dynamics and high performance.

They are available in two variants: the MC3001 B can be plugged into a motherboard with three micro board-to-board connectors whereas the MC3001 P can be plugged

in via a 28-pin plug connector. To help customers quickly and easily get to work on the development of their drive system, Faulhaber offers a starter kit that includes, among other things, a motherboard and makes it easier to get started. In addition, up to six different motherboard variants (depending on the variant of the motion controller and the used motor) are available. To meet specific customer needs, other boards can be created that may also include, e.g., an EtherCAT interface.

The motion controllers are designed for slave operation and can be easily and quickly combined with a number of higher-level master systems via standard interfaces.

After basic commissioning via Motion Manager, the controllers can alternatively also be operated at any time in stand-alone mode by means of integrated sequence programs.

www.micromo.com



We answer EVERY CALL, EVERY TIME, within TWO RINGS.

It's at the core of who we are.



NES Bearing Company has been providing American-made custom bearing products and services to customers in diverse industries for over 24 years.

-  NADCAP CHEMICAL PROCESSING
-  AS9100 CERTIFIED
-  ISO9001 CERTIFIED

NES Bearing Co., Inc.

nesbearings.com sales@nesbearings.com 877-870-3200

-  Short lead times
-  Unique Materials
-  Custom or Made to Print



Igus

INTRODUCES NEW TRIBO-MATERIAL IGLIDUR TX2

Igus now has the new tribo-material iglidur TX2 in its product range, which works without lubrication. Because even small excavators still need 50 liters of lubricant every year. The wound plain bearing bushings withstand very strong forces and increase wear resistance by a factor of 3.5 in load ranges with more than 100 MPa surface pressure.

Machines and agricultural vehicles: the construction or mining industries are exposed to challenging environmental conditions every day. Cold, heat, dust and dirt have a strong effect on the bearing points. The motion plastics specialist igus offers an alternative to frequently used metallic solutions with its plain bearing technology. Another material combination for wound bushings complements the range of injection-molded bearings in the heavy-duty range.



The tribo plain bearings made of high-strength filament fabric are used where very high loads occur. Here, the extremely strong filament in its specially interwoven design ensures maximum resistance and enables a maximum permissible compressive strength of 400 MPa. The newly developed material was extensively tested on the indoor and outdoor test rigs in the 3,800 square meter Igus test laboratory. Pivot tests on hard-chrome shafts showed that iglidur TX2 is around 3.5 times more wear-resistant than the standard heavy-duty material TX1. Like all iglidur plain bearings, iglidur TX2 is self-lubricating and operates dry. This prevents dirt from adhering to the bearing points. This reduces maintenance and repair costs, as well as machine failures due to insufficient lubrication. As the material is also very resistant to temperature, chemicals and moisture, plain bearings made of iglidur TX2 can be used in many other areas. Due to the freedom from corrosion and seawater resistance, they can also be used, for example, in moving applications in the maritime sector.

Diameters of up to 2,800 millimeters are feasible. In any case, the application of iglidur TX2 takes into account increased sustainability requirements, both underwater and onshore. “For example, according to the operators, even a small excavator needs between 50 and 60 liters of lubricants

per year”, clarifies Stefan Looockmann-Rittich, head of the iglidur plain bearing technology business unit at Igus. “Since the iglidur TX2 bearings do not need lubrication, the customer benefits threefold: not only saving costs for oil or grease and maintenance time, but also no lubricant is released into the environment.” iglidur TX2 is available from May as a standard product range in the diameters 20 to 80 millimeters directly from stock.

www.igus.com

ABB

EXPANDS MOTOR OFFERING WITH SEVERE DUTY XT

ABB expands the broadest severe duty offering in the market with the Baldor-Reliance Severe Duty XT motor.

The Baldor-Reliance Severe Duty XT motor is a true severe duty motor that bridges the gap between the ABB’s Baldor-Reliance General Purpose and XEX premium severe duty motor lines.

“When it comes to performance, the Severe Duty XT is a versatile option for what the industry expects as severe duty,” said Matt Rodebush, ABB’s NEMA Motors global segment manager. “With Baldor-Reliance Severe Duty XT motors, premium features come standard on a wide variety of configurations, so it’s easy to get up and running with a high-performance motor for the most demanding applications.”



Baldor-Reliance Severe Duty XT Motors are the solution to most severe duty application challenges. Severe Duty XT motors are built in Arkansas, Georgia, Mississippi and Oklahoma, and are available now from local inventory. These motors are easy to install and maintain and offer a wide range of standard features that cost extra on most other motors. Baldor-Reliance XT Severe Duty Motors, designed for protection and performance, come with the quality and reliability you expect from the brand you prefer.

www.baldor.com



PRECISE. ROBUST. AVAILABLE.

ServoClass® Couplings

- Zero-Backlash & High Torsional Stiffness
- Engineered Performance for Reliable 24/7 Operation
- Servo-Rated for Reversing, Positioning, Precision
- Low Inertia / Low Misalignment Reaction Loads
- Perfect for High Accuracy Actuator Systems
- Engineering Assistance / **Fast** Delivery



www.zero-max.com 800.533.1731

ZERO-MAX®

The Power Shift

Companies Look to Fuel Economy, Energy Efficiency and Operating Costs to Improve Off-Highway Applications

Matthew Jaster, Senior Editor

The big picture in automotive is quickly becoming the big picture in the entire transportation industry. For the off-highway market, this means keeping pace with energy efficiency regulations, changing fuel economy strategies, and reducing operating costs for customers when feasible. Companies like Eaton, BorgWarner, Dana and Thomson Linear continue to provide products and technologies to meet the changing demands of this market.

Off-highway is mirroring the automotive industry in terms of more efficient and productive vehicles and components today.



Eaton Expands Valvetrain Solutions in Off-Highway Applications

Eaton recently announced it has expanded its portfolio of valvetrain solutions for diesel off-highway vehicles to help OEMs reduce emissions and improve fuel economy. The company has supplied valves and valve actuators since 1930 with a diverse portfolio that includes cylinder deactivation systems, late (or early) intake valve closing, early exhaust valve opening, engine brakes, hydraulic lash adjusters, and valves, including sodium-filled valves and high-temperature resistant alloys.

In different ways the technologies listed above (except engine brakes which serve other purposes) are means to reduce CO₂ and NO_x emissions, which are typically conflicting objectives.

Fabiano Contarin, product director, commercial vehicle valve actuation, Eaton

Vehicle Group, caught up with PTE to discuss some of these valvetrain solutions.

Cylinder Deactivation (CDA), according to Contarin, consists of deactivating the intake and exhaust valve opening and the fuel injection on some of the cylinders when the engine is running at low load.

“By doing that, the total flow of air through the engine is significantly reduced while the total amount of injected fuel is nearly the same. This generates two effects: (1) the temperature of the exhaust gases is significantly higher (100°C+), allowing the NO_x aftertreatment to remain efficient at low load, which is key to meet future emission regulations and, (2) the overall efficiency of the engine increases, hence the CO₂ emissions are reduced,” he said.

Different than other technologies that

reduce NO_x at the expense of CO₂, CDA is able to reduce both NO_x and CO₂ simultaneously. NO_x reductions of 40%+ and CO₂ reduction of 5–8% on a low load cycle are to be expected.

Late Intake Valve Closing (LIVC), also known as the Miller cycle, consists of delaying the closing of the intake valve so the effective compression ratio is lower than the expansion ratio. This increases the thermal efficiency of the engine, improving fuel economy and reducing CO₂ emissions. By reducing the effective compression ratio, LIVC also enables higher geometrical compression ratios that further improve efficiency. Because of the reduced amount of air-flow through the engine (shorter intake stroke), the exhaust temperature is higher (+40°C), contributing to the thermal management of



Eaton has expanded its portfolio of valvetrain solutions for diesel off-highway vehicles.

aftertreatment. Overall LICV can bring a 1–2% CO₂ reduction.

Early Exhaust Valve Opening (EEVO) consists of advancing the opening of the exhaust valve so that the exhaust gases are hotter (less energy is transformed into mechanical work, more goes into heat). By doing this EEVO is a powerful tool to get the aftertreatment warm after a cold start.

“Hydraulic Lash Adjustment (HLA) eliminates the need for periodical service to adjust valve lash. This has multiple benefits including reduced service time, reduced noise in operation, as well as more consistent valve timing to improve engine efficiency and emissions,” Contarin said.

“Additional benefits particularly interesting to the off-highway market include



YOU CAN DEPEND ON WORLDWIDE ELECTRIC

Quality, Affordable Motors, Controls, and Gear Reducers for Demanding Industries and Applications



WorldWide Electric is a leading manufacturer of quality, affordable electric motors, motor controls, and gear reducers and an exclusive master distributor of **Hyundai Electric** low-voltage motors and drives. Offering fast, often same-day, shipping from 6 regional warehouses, WorldWide Electric is committed to exceeding your expectations on product availability, value, and speed & quality of service.

Call us or visit us online!

(800) 808-2131 / worldwideelectric.net

Superior Customer Support
Driven to provide the best possible customer experience

Proven Quality & Affordability
Premium motors, controls, & gear reducers at competitive prices

In Stock When You Need It
\$50M in inventory stocked at 6 regional warehouses

Same-Day Shipping Available
Most orders placed before 2PM local warehouse time can ship same-day

WorldWide Electric Corporation | 3540 Winton Place, Rochester, NY 14623
Distribution Centers located in Allentown, PA | Atlanta, GA | Dallas, TX | Indianapolis, IN | Los Angeles, CA | Seattle, WA

the ability to avoid valve lash setting in the field with risk of engine contamination and operator errors and it enables packaging the aftertreatment on top of the engine (in case of mechanical lash adjustment, aftertreatment would need to be removed to do the lash adjustment,” he added.

Improving emission performance often requires running with higher cylinder pressures and temperature. Eaton can also help on this front with proprietary valve alloys such as Crutonite, and

potentially leveraging the hollow valve technology widely used in passenger car applications.

Eaton’s valvetrain control functions offer a variety of flexibility and adaptability. “They are based on two building blocks: a rocker with a switchable capsule and a split rocker for full deactivation. By combining these two building blocks a wide variety of VVA strategies can be realized in virtually any engine architecture: single and dual overhead cam, as well as in cam-in-block engines,”

Contarin said.

Although plans for introducing new regulations are not firm, Contarin expects a new regulatory step in the 2027–2029 timeframe (Tier 5/Stage VI) imposing NOx reduction as high as 90% and CO₂ reduction of 10–15%. This is relatively similar to what is happening with on-road vehicles (EPA 2027, Euro VII), with a lag of 1–2 years.

“This will certainly drive technology implementation and different degrees of electrification. The off-highway market being very fragmented makes it difficult to speak in general terms, however we expect diesel engines to remain predominant in the mid-term, and VVA technologies to play an important role to enable OEMs to meet the new regulations. As mentioned above what makes VVA stand out from the alternatives is that it provides benefits on both the NOx and CO₂ front,” Contarin said.

All of this matters because of the number of off-highway vehicles there are vs. on-highway.

“Perception is it is a niche market, but in reality, it’s not. In 2020 4.3M engines were produced for off-highway applications while 3.5M were manufactured for on-highway. So making them cleaner is just as important,” he concluded.

www.eaton.com

LAFERT
NORTHAMERICA

SITI®

**YOUR BEST SOURCE FOR METRIC
MOTORS, GEARBOXES & COOLANT PUMPS**

RIGHT ANGLE WORM GEARBOXES

Available with stainless steel
output shaft

Hollow, or solid output shaft in
single or double design

Single & double reduction available

Ratios of 5:1 to 100:1
(single stage reduction)

Ratios up to 10000:1
(combination gearboxes)

Variety of input and output
mounting combinations in
each frame size.



AMERICAN
CLEAN
POWER

EASA
The Electro-Mechanical Authority

PTDA

Toll Free: **1-800-661-6413**
Fax: **1-905-629-2852**

www.lafertna.com
sales@lafertna.com

Heavy-Duty Drivetrains with Dana

The Spicer 246 heavy-duty steer axle and Spicer C3300 remote torque converter are offered as part of a complete drivetrain solution for rough-terrain cranes that delivers premium performance through improved gradeability and travel speeds, higher efficiency in the field, increased productivity, and reduced operating costs.

“As the global construction market recovers, buyers are looking for high-performing vehicles that deliver exceptional productivity and efficiency,” said Aziz Aghili, president of Dana Off-Highway Drive and Motion Systems. “Dana’s large and growing capabilities for rough-terrain cranes enable us to anticipate market shifts and collaborate with original-equipment manufacturers to supply the drivetrain technologies that improve their competitiveness.”

Dana’s new heavy-duty Spicer 246 steer axle features a monolithic axle design and high integrity seals that deliver exceptional performance in the most severe working conditions. It features optimized steering geometries to minimize slippage, while the single universal joint design with outboard planetary gears provides high output torque and high-capacity braking with low drag at travel speeds.

Currently available for OEM field testing, the Spicer 246 axle can also be adapted for use with airport ground support vehicles, where it can be configured with optional wet brakes.

Dana has also developed the new Spicer C3300 remote torque converter



Performance upgrades are essential for rough terrain cranes in the off-highway market.

specifically for rough-terrain cranes. It is optimized for engines up to 195 kW (260 hp) and can be packaged with Spicer remote transmissions. Dana is the only manufacturer worldwide that supplies a remote torque converter with three large pump drives for implements.

The Spicer C3300 remote torque converter is available with an optional lockup that improves efficiency while providing higher braking effort during downhill operation. It features new converter wheel sizes configured to

optimize the performance of today’s low-RPM engine designs.

Available now, the Spicer C3300 remote torque converter is already in use in terminal tractor applications, where it enables lower heights for fifth wheels.

Dana has a large and growing selection of drive and motion technologies for manufacturers of tracked and wheeled cranes.

Earlier this year, Dana introduced a new series of Spicer Torque-Hub drives for crawler cranes and other large-tracked vehicles. With torque ratings from 80,000 N-m up to 450,000 N-m, the new drives offer flexible packaging and gear ratios to meet manufacturer preferences for tracked and wheeled applications.

Also, Dana offers high-performance Brevini winches for cranes and other applications with lift capacities from 1.1 tons (990 kg) to 33 tons (30 tonnes).

Additionally, Dana supports the work functions of cranes with a wide selection of Brevini slew drives, hydraulic pumps and motors, and proportional directional valves.

www.dana.com

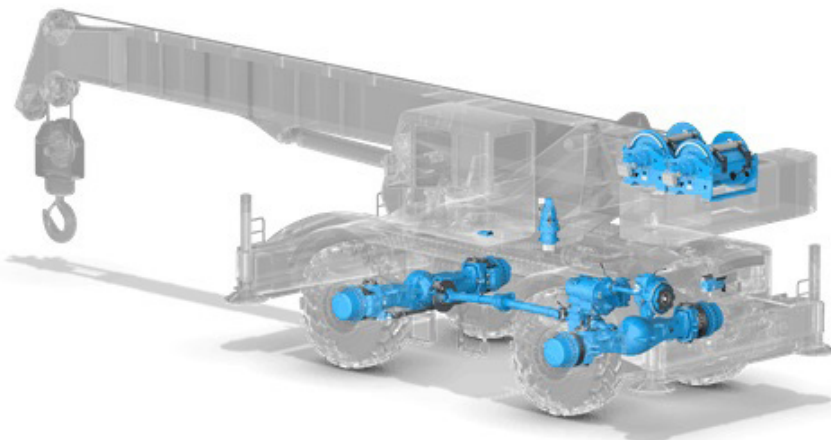

Dana has anticipated market shifts with its latest drivetrain technologies.

BorgWarner Powers Commercial Vehicles with HVH 320

BorgWarner's High Voltage Hairpin (HVH) electric motor, the HVH 320, can power a variety of hybrid and electric applications for commercial vehicle manufacturers, including a large European OEM. Production of the HVH 320, which is equipped with 800-volt capabilities and available in four variants, is expected to kick off in 2024. Its multi-faceted platform will support the manufacturers' goal of a common electric drivetrain and deliver



BorgWarner's High Voltage Hairpin (HVH) electric motor, the HVH 320, can power a variety of hybrid and electric applications for commercial vehicle manufacturers.

approximately 97% peak efficiency and over 400 kW of power.

BorgWarner leveraged its motor production experience to design four variants of its modular and flexible HVH 320 motor platform to meet the customer's requirements. The motor offers clean and quiet operation, while reaching a torque output of up to 1270 Nm. Also, the technology supports the vehicle's shifting sequence and charges the battery by generating power while braking or driving downhill.

The HVH 320 motor is the newest addition to BorgWarner's portfolio of HVH series motors, which are offered to both light-duty passenger cars and heavy-duty commercial vehicles. These versatile motors feature patented stator winding technology, are easy to integrate and are available as fully housed motors or as rotor/stator assemblies. Additionally, the motors can be used in a variety of architectural positions throughout a vehicle. BorgWarner also offers inverters that can achieve the same, next-generation 800-volt level.

"Adding the HVH 320 to our electric motor family bolsters our offerings and is an excellent example of BorgWarner's commitment to delivering state-of-the-art clean propulsion technologies that match market needs," said Dr. Stefan Demmerle, president and general manager, BorgWarner PowerDrive Systems. "Using our 800-volt rated machine, customers can significantly reduce charging time and achieve a higher power density, enabling an even brighter future for electric trucks."

www.borgwarner.com

TWO SPEED SPINDLE DRIVES

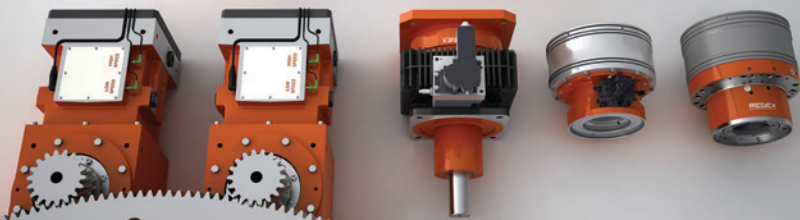

PLANETARY REDUCERS

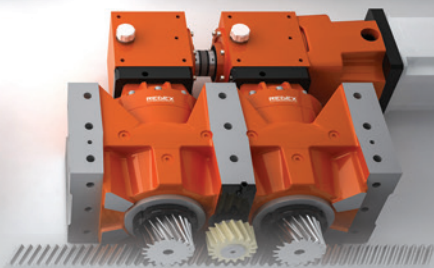
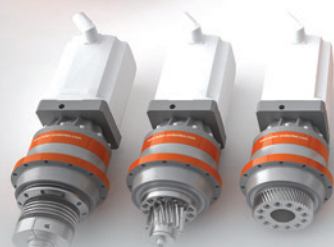

Providing Quality Unique Gearboxes & Solutions
For Use On Industrial Machinery

ANDANTEX USA Inc.

andantex.com

info@andantex.com

Phone: 877-966-9151

1705 Valley Road, Wanamassa NJ 07712

Thomson Offers H-Track Electro-Hydraulic Linear Actuators

Designers for heavy duty motion control applications have traditionally specified hydraulic cylinders for their high speed, heavy load handling and resilience. However, recent advancements that embed hydraulic technology within electric linear actuators have been delivering the benefits of hydraulics without the common drawbacks.

H-Track actuators incorporate a patented fluid power design, which provides high load capability for extreme duty use, a more compact pin to pin than other actuators of the same load capability, excellent ingress protection and corrosion resistance. The H-Track uses an external gear pump connected to a reservoir and actuator, yielding the most impact resistant

Warner actuator. The H-Track pump is burnished, cleaned, flushed and vacuum filled with degassed hydraulic fluid. The system is completely sealed with no hoses to leak. This ensures you receive contaminant free and maintenance-free product for the life of the actuator.

The H-Track electro-hydraulic linear actuator is an all-in-one, self-contained

system that can tolerate extreme shock loads, prevents leaks and features a higher speed profile. It allows personnel to avoid the messes, complexities, contaminants, and maintenance associated with traditional hydraulic cylinders. For more information regarding these innovations download Thomson's white paper, "Why Electric Actuators are Increasingly Replacing Hydraulic Systems," here:

www.thomsonlinear.com/en/products/linear-actuators/white-paper.



H-Track actuators from Thomson Linear incorporate a patented fluid power design, which provides high load capability for extreme duty use.

For Related Articles Search

off-highway

at www.powertransmission.com

Power Transmission Engineering online!

It's like your own professional superpower.

Stronger, faster and smarter than your average website, www.powertransmission.com offers everything you need to supercharge your engineering-oriented organization.

- Complete archive of articles on engineered components
- Directory of suppliers of gears, bearings, motors and other mechanical power transmission components
- Product and Industry News updated daily
- Exclusive online content in our e-mail newsletters
- The Bearings Blog
- Calendar of upcoming events
- Comprehensive search feature helps you find what you're looking for — *faster than a speeding bullet!*

www.powertransmission.com

Electric Car Safety

Freudenberg Provides DIAvent Pressure Equalization Element for Chinese Passenger Cars

Freudenberg Sealing Technologies

The innovative DIAvent pressure compensation element from Freudenberg Sealing Technologies provides pressure equalization in batteries for electric cars both during normal driving and for emergency venting in the event of damage or accidents. It is therefore an important safety feature for battery-powered vehicles. Freudenberg Sealing Technologies is now starting high-volume production of the component for the first time for use in a Chinese passenger car: DIAvent will help to ensure battery safety in the new ARCFOX α-T electric car from the Chinese manufacturer Beijing Electric Vehicles (BJEV).

In 2017, Freudenberg Sealing Technologies introduced its innovative pressure compensation element DIAvent to the public: In batteries for

electric vehicles, a valve consisting of two nonwovens with different properties takes over pressure equalization during normal operation. Excess pressure reduction during emergency

degassing is handled by a reversible umbrella valve. As simple as it sounds, the solution is very technically sophisticated. While only a few liters of air per minute are exchanged in both directions during normal operation, in an emergency the entire quantity of gas emitted from a defective cell must be removed in a few seconds. Otherwise, the strong internal pressure - many times higher than the ambient pressure - could cause the housing to burst.

The trend towards battery systems with even higher energy density is another challenge. This is because it also increases the amount of gas that must be quickly removed in case of an emergency, as well as the amount of air exchanged during normal operations.

Freudenberg's patented DIAvent valve replaces typically used micro-porous film like PTFE with a combination of two nonwovens with different properties. The water-repellent nonwoven fabric on the outside allows air exchange of approximately eight liters per minute at a low-pressure difference. And it is watertight up to 100 millimeters of water column. If the water pressure rises above this, a second

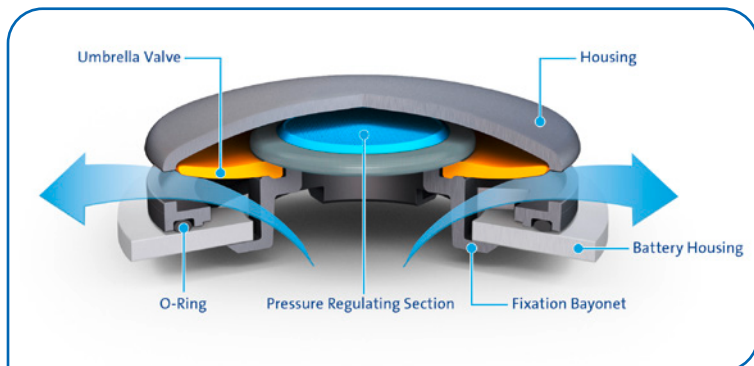

FST DIAvent open.

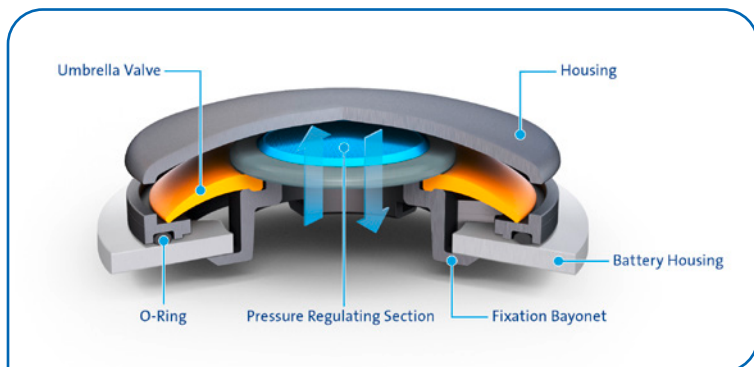

FST DIAvent closed.

inner layer of nonwovens is activated so that no water can enter the housing. Degassing in an emergency is made possible by an umbrella valve that is arranged in a ring around the nonwoven fabric. It opens reliably as soon as the pressure in the housing exceeds the atmospheric air pressure by more than 50 millibars and can then discharge 40 liters of gas per second. A major advantage of the DIAvent: the umbrella valve closes again at the end, making it easier to safely remove a damaged battery after emergency degassing. Since it reversibly opens and closes, it can also support pressure equalization in normal operation, for example when batteries with high energy density are exposed to rapid temperature fluctuations.

Another advantage of DIAvent is that it takes over the functions that are usually performed by two separate components—a breathing element and a bursting disc. This means it is more economical and easier to install for vehicle manufacturers, since only one component has to be installed.

Right after prototype production, several vehicle manufacturers expressed their interest and tested the pressure compensation element from Freudenberg Sealing Technologies. At the beginning of 2020, DIAvent went into series production for European customers for the first time. Two years ago, Freudenberg's sealing experts launched a joint development and test project with the Chinese manufacturer BJEV, which was successfully concluded with an agreement for series production in 2020.

"The cooperation with BJEV was very intensive. We are very proud that our engineering expertise helps our customer to continue its road to success," explained Liu Zehua, account manager and sales representative at

NOK-Freudenberg. "With this project, Freudenberg truly demonstrated its global footprint: The company managed a complex global customer project with local sales in China, and engineering and production in Europe." BJEV, which has been operating successfully in the Chinese automotive market for about 30 years, now wants to establish a stronghold in the European market as well. That is why cooperation with established local suppliers was important to the company, especially in view of the strict European safety standards for passenger cars.

"We are delighted that DIAvent is now going into series production for the first time at a Chinese OEM," says Matt Chapman, president, automotive

sales and marketing at Freudenberg Sealing Technologies. "The high demand for this product shows us that we know the needs of our automotive customers very well and that we are using our expertise precisely for innovations to support our customers in the difficult transition to electric mobility. And in doing so, we are also pointing the way to emission-free mobility in general." **PTE**

www.fst.com

For Related Articles Search

seals

at www.powertransmission.com

60 Years Proven

ROBOTICS • AEROSPACE • DEFENSE • TRANSPORTATION • MEDICAL

When failure is not an option, call on Spiroid.



Spiroid's skew-axis, high torque gears enable world-class power density in a small footprint.

SPIROID
HIGH TORQUE GEARING

Contact us today: 320-762-7133 • SpiroidGearing.com

Advanced Capabilities

Freudenberg Expands Material Testing for the Seal and Safety of Lithium Batteries

Freudenberg Sealing Technologies has expanded its material testing capabilities to include performance and compatibility evaluations of the rubber, elastomers and thermoplastics used to seal and safely maintain lithium-ion batteries. The company has installed sophisticated equipment and adopted new testing protocols in its Plymouth, Mich., Central Laboratory that will provide conclusive data on which materials optimally resist breakdown from constant exposure to harsh electrolytic solutions. Such data has not been readily available in the private sector until now.

The centerpiece of the six-figure investment is a specially designed Isolation and Containment Chamber (IsoC) that allows technicians to safely conduct exposure testing using the aggressive lithium electrolytic solutions found in lithium-ion battery cells. These solutions are volatile, toxic, and flammable when exposed to oxygen and ambient air moisture. The IsoC, a six-by-three-by-three-foot, two-chambered glass, and steel enclosure, allows chemists to work in a controlled, inert, and moisture-free environment.

In addition, Freudenberg Sealing Technologies also invested in a sophisticated telemetry control system that facilitates remote IsoC monitoring of the active work 24/7, head-to-toe protective gear and special respirators for chemists, non-reactive, nickel-based immersion vessels, a safety monitoring and alarm system and electrolytic solutions costing thousands of dollars per gallon.

“What we can now offer customers is design security based on scientific data,” said F. Joseph Walker, director research and development for Freudenberg Sealing Technologies in the Americas. “We have taken this

proactive step on behalf of our customers and in response to a growing use of lithium-ion batteries in diverse applications. “Previous effort has been conducted to determine the impact of materials on the electrolyte. This work focuses upon the impact the electrolyte has on the materials.”

Multiple analyst forecasts project that the lithium-ion battery market will experience double digit growth during the next five years based on increasing battery use in the automotive, construction agriculture, min-

solvents can result in a faster exchange of lithium ions between the anode and cathode sides of a battery cell—thus ultimately impacting energy discharge and recharge rates—they also expose seals, gaskets and other battery components to a constant mix of reactive, flammable, caustic and hazardous chemicals.

Freudenberg Sealing Technologies has spent decades performing comprehensive physical and analytical material testing to document the performance and compatibility of mate-



Freudenberg Sealing Technologies continues to build its lithium-ion battery expertise with the installation of a sophisticated Isolation and containment chamber in its Plymouth Central Laboratory in the United States.

ing, commercial truck, recreational vehicle, ship, train and electronics industries. In response, the lithium-ion battery developers are constantly exploring ways to make these sustainable energy devices more powerful, more robust and faster during recharging cycles. Electrolytic solutions have a direct impact on these performance issues. New and enhanced electrolytic solvents are being continuously introduced. While these

materials that are exposed to different fluids, materials and stress conditions. The data base the company has assembled from the results provides specification guidance and material benchmarks for the components it sells to customers.

Lithium-ion material testing, however, requires a unique set of inputs to safely succeed. The new equipment and test methodology being used in the Central Laboratory provides

these inputs.

“All of our exposure testing must be performed inside the IsoC in an oxygen-free, moisture-free environment,” said Freudenberg Sealing Technologies’ Michael Saruna, the Central Laboratory chemist who is in charge of material testing in electrolytic solutions. “Electrolytic solution exposed to air can result in a hazardous situation, so we had to take safety and our ability to maintain a controlled environment into account during the design of the IsoC.”

The dual chambers of the IsoC allow Saruna to install test samples in the first chamber, purge all air, oxygen and moisture from that space and then move them to the second, larger IsoC chamber for exposure testing. Materials will be immersed electrolytic solution for at least 1,000 hours, then decontaminated to insure they are safe for removal from the IsoC. They will then be subjected to the company’s standard physical and analytical test methodologies.

Freudenberg will use two electrolytic solutions in its immersion testing—one that is commonly used in lithium-ion battery cells and one that has been manufactured as a control. The company will test families of materials, beginning with its own unique and proprietary materials and then moving on to test commercially available materials that are used in these batteries.

“Benchmarking will provide us with the ability to spot gaps in compatibility and performance,” Walker said. “Then we can develop material programs and components to fill those gaps.” **PTE**

YOUR **ZIP** SIDEKICK FOR POWER TRANSMISSION SOLUTIONS THAT TRANSFORM YOUR OPERATIONS.

Join the zip chain revolution with the Zip Chain Actuator® (ZCA). The ZCA uses a unique segmented roller chain, paired with a special sprocket that “zips” the chain together into a rigid push-pull actuator with high speeds and a small footprint. Use the ZCA so you can optimize space, save time, and solve operational problems in your factories. That’s what you can expect from your trusted, reliable sidekick.

NEW... ZIP CHAIN ACTUATOR®

OUTPERFORMS
LINEAR ACTUATORS
BY OFFERING:

- > High speed
- > Longer life
- > Multi-point stopping
- > Compact design



Want us to optimize your operations?
That’s what we do. Call us today to schedule
an on-site visit 800-323-7790

©2021 U.S. Tsubaki Power Transmission, LLC. All Rights Reserved.

TSUBAKI
LEADING THE MOVEMENT

For Related Articles Search

electrification

at www.powertransmission.com

Simple, but Tough

Radial spherical plain bearings play a key role in off highway equipment and vehicles

John Wallace, Vice President of Operations, AST Bearings and
Steven Sanchez, P.E., BSA Certified Bearing Specialist, Engineering Manager, AST Bearings

Original equipment manufacturers (OEM) of off-highway equipment and vehicles are continuously looking for new ways to apply technology into their designs, both new and old—anything that will give their products an edge in productivity, payloads, and efficiency.

The machines and vehicles they produce must endure extreme environments, demanding operating conditions, and heavy loads. Reliability and ease of maintenance are paramount; repairing equipment on-site is costly, and often almost impossible. However, many designs are built upon tried-and-true platforms that incorporate drivetrains, suspensions, steering linkages, torsion bars, connecting rods, articulated joints, heavy duty linkage pivots, and hydraulic cylinders. All of these applications have something important in common: they use radial spherical plain bearings and rod ends. Engineers have yet to develop bearings that better accommodate the combinations of movements and heavy loads these vehicles and equipment encounter, with reliability and cost-effectiveness.

Here's what you should know about these relatively simple and extremely tough bearings found in most off-highway applications.

How they work

Radial spherical plain bearings have an inner ring with a sphered convex outside surface, and an outer ring with a correspondingly sphered (but concave) inside-sliding contact surface. The two general styles relate to the manufacturing method. *Swaged* style bearings are made by “swaging,” or forming, the outer ring over the inner ring (or ball). *Fractured* style bearings have an outer ring that is split, or fractured, in one position to facilitate assembly of the rings during manufacturing.

The bearings can be comprised of different sliding contact surface combinations, i.e. the sliding surfaces of inner and outer rings are made from different materials. Some combinations require maintenance (such as steel-on-steel), while others do not.

Wheel loading excavator unloading sand at a construction site (all photos courtesy of AST).



Comparison to rod ends

Rod ends consist of an eye-shaped head with integral shank, forming a housing and one of three options: a standard spherical plain bearing, a spherical plain bearing inner ring, or a spherical plain bearing inner ring with a sliding layer between the bore of the head and the inner ring. As a rule, rod ends are available with left or right-hand female or male threads. Rod ends can have the sliding contact surface combinations steel-on-steel, steel-on-bronze, steel-on-PTFE composite material, or steel-on-PTFE fabric.



Various sizes and styles of rod ends and spherical plain bearings.

Rod ends and spherical plain bearings share common design principles and function in the same manner, designed to handle radial loads under misalignment. Rod ends are more common in linkages and connecting rods due to their ease of mounting and adjustment. They can be selected with sliding contact surface combinations that render them maintenance-free, or the steel-on-steel style can accommodate a grease fitting, allowing for regular re-lubrication.

Spherical plain bearings, however — due to their construction and internal geometry — can handle heavier radial loads under misalignment than rod ends. They accommodate misalignment between the housing and shaft, as well as oscillating movements at slow speeds. While these bearings can handle a small amount of axial load, they should be used where the load is primarily radial.

Varieties and case studies

Maintenance (steel-on-steel) spherical plain bearings are more common in off-highway applications. These bearings have a hardened sliding contact surface on both rings. The surfaces are treated with molybdenum disulfide (MoS_2) lubrication and a phosphate coating. They have both wear and corrosion-resistant characteristics. Bearings with this sliding contact surface combination require initial, and regular lubrication. The high strength of the sliding contact surfaces makes these bearings especially suitable for bearing arrangements where heavy loads of alternating direction, shock loads or heavy static loads have to be accommodated. Unless properly protected, maintenance free bearings with liners (PTFE composite or PTFE fabric) are subject to deterioration from contamination, and they are not well suited for heavy alternating loads.

Since bearings with steel-on-steel sliding contact surface combinations require regular relubrication, they typically have

lubrication holes and grooves in the inner and outer ring to allow grease to flow into the areas of sliding contact. It is important these features line up with the grooves and grease fittings in the mating components when mounted.

When mounting bearings with a fractured outer ring, it is critical that the joint be positioned at 90° to the main load direction, otherwise the service life will be shortened, particularly under heavy loads. The angle of tilt, or misalignment, is usually noted with the symbol α in most catalogs and can vary from 3° to 15° . Bearing tolerances, internal clearances, and recommended fitting practices are listed in the Engineering sections of most catalogs. In the US, ANSI/AFBMA Standards 22.1 and 22.2, Series 3, covers these types of bearings.

One of the most common uses of spherical plain bearings in off-highway equipment is with hydraulic cylinders, linear actuators designed to deliver force in a single direction, because they're effective in dealing with misalignment — a common cause of hydraulic cylinder failure. Spherical bearings are often used in the clevis style mounts of hydraulic cylinders. Deviations from the centerline of the load, introduce what is known as “side loading”. This places lateral stress on cylinder pistons, seals, bushings and rods — these components are not designed to withstand these forces, so they will fail quickly. Spherical bearings allow for some degree of misalignment due to side loading, improving cylinder longevity.



Hydraulic hoses of a modern tractor.

A typical excavator or backhoe has a half dozen cylinders, or more, for the bucket, boom, dipper, outriggers, steering, and other equipment and accessories on the vehicle where these bearings are used, in addition to steering linkages, shock absorbers, and pivot points.

Spherical plain bearings are available in various types and configurations to address specific loading and operating conditions, and environmental conditions.

Sealed Type

Spherical plain bearings are available with seals to protect the sliding surfaces in severe environments. The seals are affixed to the outer ring and make positive contact with the inner ring keeping dirt and debris out, and the lubricant in. Variations in seal materials and design vary from manufacturer, but most seals are either a polyester elastomer material or a buna nitrile rubber bonded to a sheet steel insert. These plastic and rubber seals are best suited for applications where the bearings see frequent tilting or circumferential movement. This tends to keep the contact surfaces clean.

Extended Inner Ring

To ease assembly, and eliminate the need for spacers, these bearings are also available with an extended inner ring design. These have a slightly higher cost.

High Angle

Depending on their size, most spherical plain bearings accommodate misalignment in the 5 to 15 degree range. However, higher angles of misalignment can be accommodated with a special series. This series has an increased cross section inner ring which allows for the higher angle of tilt, up to 20 degrees.

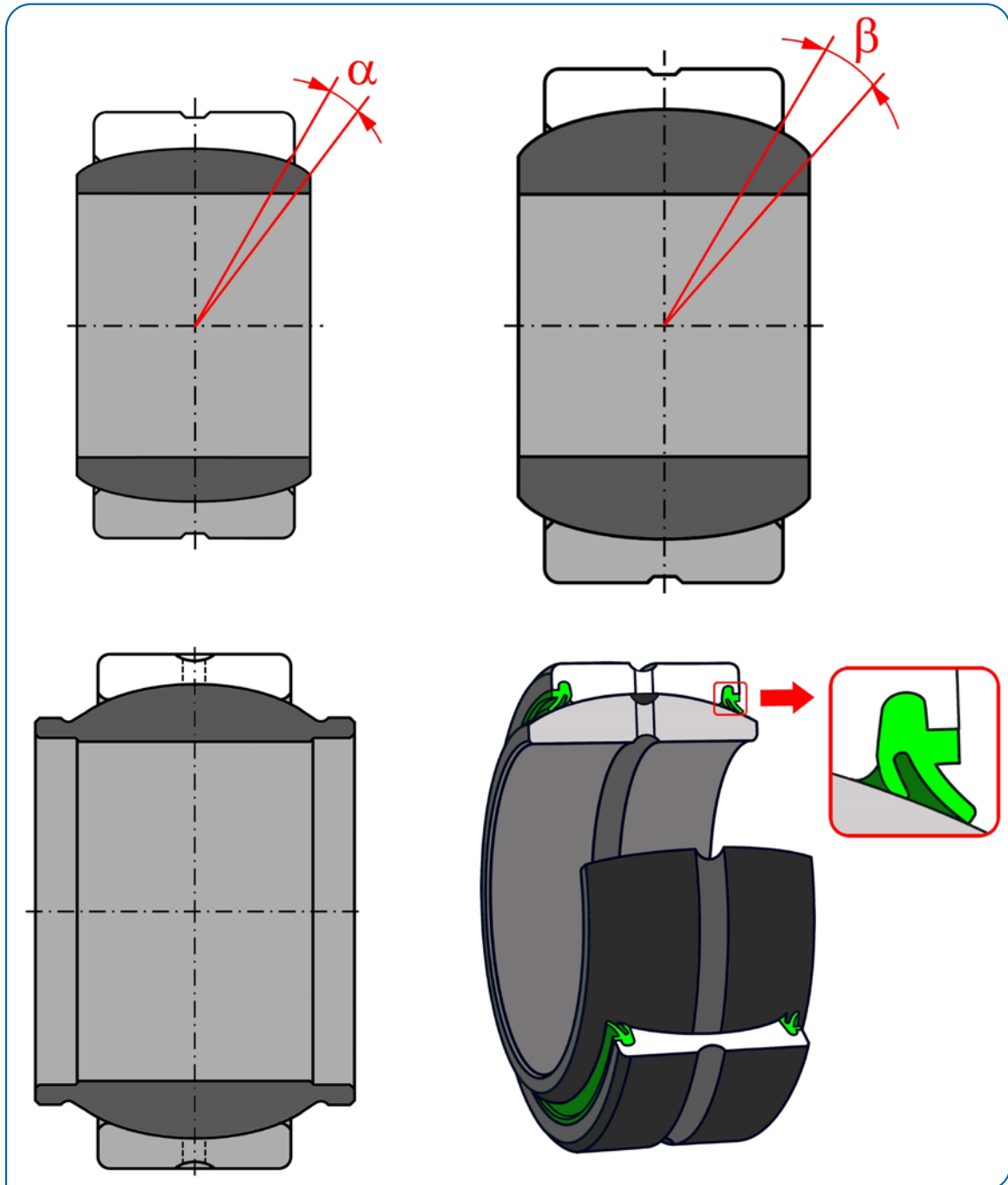

Spherical plain bearing configurations (Upper Left: Standard, with misalignment Angle α ; Upper Right: With higher misalignment Angle β ; Lower Left: Extended inner ring; Lower Right: Seal type).

Impact Resistant

In some off highway applications shock or impact loading is common and can have a devastating effect on bearings. Most spherical plain bearings are manufactured from thru hardened 52100 chrome steel. These bearings have good wear resistance and fatigue strength. However, with their high hardness, they are susceptible to chipping, cracking, and breaking under these conditions. Spherical plain bearings manufactured from low carbon, carburizing steels, such as 8620, and processed with a special heat treatment known as case hardening are recommended in these applications. The case hardening provides an outer layer of high hardness for wear resistance and fatigue and the core of the bearing is “softer”, or more ductile, which allows the bearing to absorb impact. These bearings carry a price premium.

Loading and life

Spherical plain bearings can accommodate loads in both the axial and radial directions, with the load predominantly radial for the latter. Angular contact types are available for heavier thrust or axial loading. Loads can be in combination, and the direction constant or alternating.

Other loading considerations:

- Loads are dynamic when sliding movements take place in a loaded bearing, causing wear in the bearing.
- Dynamic loads can be oscillatory or rotational. Oscillatory loads can be accommodated only along the lateral axis and are limited to the angle of misalignment, or tilt, designed into the bearing.
- The higher the frequency of oscillation, the lower the bearing life for a given application.
- Under static load, the limiting factor is the strength of the material of the bearing or rod end.

While these bearings have very straightforward construction and operating principles, calculating service life is tricky—so engineers are advised to contact the manufacturer for assistance. The values of load ratings depend on the definition used, so it’s not always possible to make direct comparisons with load ratings published by each manufacturer.

Dynamic load rating

Dynamic load rating is used for calculations when the spherical plain bearing is subject to dynamic stress. It represents the load, constant in magnitude and direction, under which a basic rating service life, expressed as a sliding distance, will be attained for continuous oscillating movement at a defined sliding velocity at room temperature. It assumes that the load acting on radial and angular spherical plain bearings and on rod ends is purely radial, and that the load acting on spherical plain thrust bearings is purely axial and acts centrally. Dynamic stresses often occur in combination:

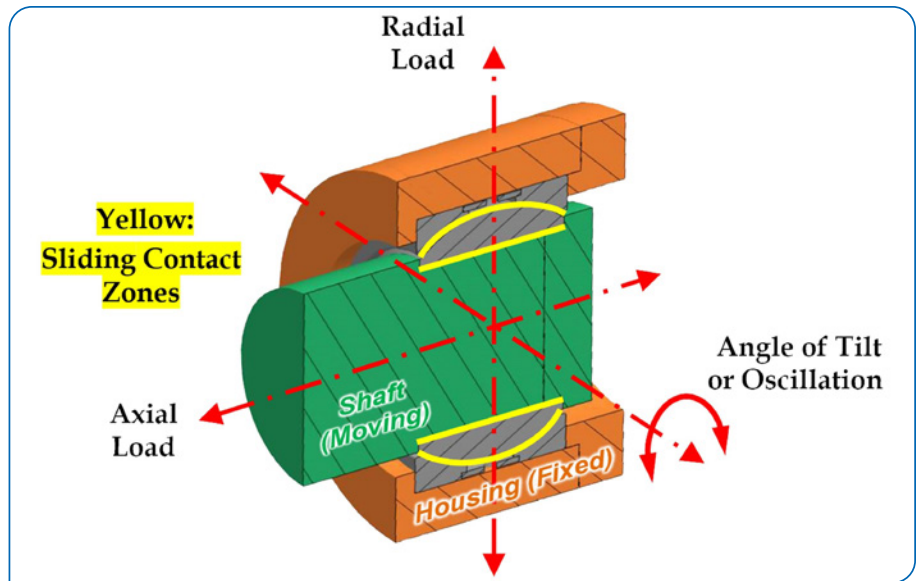

Cross sectional view of spherical plain bearing installed with shaft and housing. Radial and axial load axes, sliding contact zones.

BEYTA GEAR SERVICE

**PUTTING
A LIFETIME
OF
GEAR
DESIGN
EXPERIENCE
TO WORK FOR YOU**

- Reverse engineering
- Gearbox upgrades
- Custom gearbox design
- Specification development
- Project management
- Vendor qualification

- Design reviews
- Bid evaluations
- Tooling design
- Customized gear training
- Equipment evaluation
- Custom machine design

Charles D. Schultz
chuck@beytagear.com
[630] 209-1652

www.beytagear.com

when tilting, oscillatory or rotational movements are made under load; with micro-sliding movements under alternating loads; and with loads alternating at high frequency.

Static load rating

Static load rating is used when spherical plain bearings remain stationary under load, with only occasional alignment movements. It should be considered when dynamically loaded bearings are subject to heavy shock loads.

The static load rating represents the load which can be taken by a spherical plain bearing when static contact stress of the bearing contact surface reaches the material stress limit. It is valid at room temperature and it assumes that the surrounding components prevent deformation of the bearing.

At higher temperature, it must be multiplied by a temperature factor dependent on the sliding contact surface combination. The temperature factor is the same as for a dynamically stressed bearing. It is also necessary to take into consideration the permissible temperature range for the various sliding contact surface combinations. For rod ends, this is the strength of the rod end housing under stationary load. The rod end static load ratings give a safety factor of 1.2 times the tensile strength of the rod end housing material.

Service life

The service life of a spherical plain bearing is expressed as the number of oscillating movements, or the number of operating hours, which the bearing will endure before a defined increase in bearing clearance or a defined increase in friction is reached.

The service life of a spherical plain bearing operated under mixed or dry friction conditions is determined by the increase in bearing clearance / bearing friction caused by progressive wear of the sliding surfaces, plastic deformation of the sliding material, and fatigue of the sliding surface. Depending on the application, the permissible wear and increase in friction will be different — meaning the service life which can be obtained in practice will be different, even under the same operating conditions.

The effective service life is how long a given spherical plain bearing lasts under actual operating conditions. It is primarily determined by the magnitude and type of load, as well as contamination, corrosion, high-frequency load and movement cycles, and shock. Some of these factors are impossible to determine or can only be determined with difficulty.

Lubrication

Metal-on-metal spherical plain bearings

For spherical plain bearings requiring maintenance (metal-on-metal), lubrication increases a bearing's life by reducing friction and wear, with the added benefits of reducing noise and providing a barrier against corrosion.

In order for the lubrication to be effective, the grease must flow into the load areas — the contact zone between the inner and outer ring. When the grease cannot flow into the load zone, the bearing must be unloaded in order to effectively lubricate it. Regular re-lubrication of the bearing during its operation, on an established schedule that's re-examined when operating conditions change, will substantially extend its service life. NLGI

grade 2 greases with EP additives are recommended.

Insufficient lubricant in the load zone allows for metal to metal contact and leads to premature bearing failure. Bearings with special groove patterns on the inner ring (ball) are available that increase bearing life in dirty and extreme environments. These grooves promote more efficient lubricant distribution by providing additional channels to move lubricant into the load zones. In addition, the grooves move and capture dirt and debris thus keeping these contaminants off the raceway surfaces. These bearings also carry a price premium.

Maintenance-free steel-on-PTFE spherical plain bearings

For steel-on-PTFE lined (fabric or composite) spherical plain bearings, it's important to refrain from additional lubrication. Any lubrication of the sliding contact surfaces could disturb the internal self-lubricating properties and shorten the bearing's service life.

When operating conditions require enhanced sealing and protection against corrosion, it is recommended to fill the space surrounding the bearing with lithium-based grease.

Summary

Radial spherical plain bearings serve an important function within the off highway world, particularly in the construction, forestry, and agricultural sectors, because they're crucial to the equipment and vehicles used in those industries. They're key to OEMs' ability to create reliable products that endure extreme environments. Knowing the basics about radial spherical plain bearings, and how they compare to other commonly used components, is fundamental to making good design choices. **PTE**

www.astbearings.com

John Wallace is a degreed Mechanical Engineer with over 30 years of industry experience in Engineering, Manufacturing, and Quality Assurance. He has been Vice President of Operations at AST Bearings since 2003. John can be reached at John.Wallace@astbearings.com.



Steven Sanchez, P.E. is a degreed Mechanical Engineer, a licensed Professional Engineer in the State of New Jersey, and a BSA Certified Bearing Specialist with over 25 years of industry experience in Engineering & Manufacturing. He has been the Engineering Manager of AST Bearings since 2013. Steven can be reached at Steven.Sanchez@astbearings.com.



For Related Articles Search

bearings

at www.powertransmission.com

WorldWide Electric Corporation

Quality Products & Exceptional Customer Service

Since 1998, **WorldWide Electric** has strived to provide the best customer experience in the industry by exceeding our customers' expectations when it comes to product availability, value, and the speed and quality of service. With services like 24/7 emergency technical support and after-hours shipping, going above and beyond for our customers is ingrained in our DNA.

We are ready to serve you with an extensive inventory of quality, affordable electric motors, variable frequency drives, soft starters, definite purpose control products, and gear reducers. In addition to the WorldWide Electric brand, we are also an exclusive master distributor and representative of Hyundai Electric's low-voltage electric motors and drives and Louis Allis specialty motors and factory-recertified motors.

We take pride in offering quality products that our customers can count on to withstand demanding conditions in industries like agriculture, aggregate, fluid power, food processing, material handling, oil and gas, and water management. In addition to being manufactured according to a stringent quality assurance program, WorldWide Electric products feature high-end design elements like premium bearings in motors and case hardened, precision ground, A.G.M.A. rated gear sets in our gear reducers.

With \$50M in inventory across 6 regional warehouses in Allentown, Atlanta, Dallas, Indianapolis, Los Angeles,

Motors • Controls • Gear Reducers



and Seattle, WorldWide Electric has the unique ability to ship most orders same day and deliver products to our customers quickly. Our ready-to-ship inventory even includes hard-to-find models that commonly require a special order from other manufacturers. With the convenience of WorldWide Electric's online ordering, our customers can independently access pricing and inventory information and place orders at any time of the day or night.

Give us a call at (800) 808-2131. Our customers love the experience of being able to get a real, knowledgeable, and experienced sales representative on the phone whenever they call, and we are confident that you will be impressed by our accessibility, professionalism, and expertise too.

Same-day Shipping from 6 Warehouses

- Allentown
- Atlanta
- Dallas
- Indianapolis
- Los Angeles
- Seattle



FOR MORE INFORMATION

3540 Winton Place, Rochester, NY 14623

Phone: 800-808-2131

Email: customerservice@worldwideelectric.net

www.worldwideelectric.net

WE'RE

ALL IN

MOVING THE FUTURE.

3M Science.
Applied to Life.™

**ASH GEAR
AND SUPPLY**
INDUSTRIAL GEAR AND TOOL DISTRIBUTION

Best Gears (India) Pvt. Ltd.

Blaser.
SWISSLUBE

BK BOURN
& KOCH

**BRELIE
GEAR**

CAPSTAN
ATLANTIC

CHAO CHIA GEAR
— 1983 —

Circle  Gear

CK POWER

Columbia Gear
Corporation
A SUBSIDIARY OF INDUSTRIAL MACHINERY COMPANY

Dontyne
Systems

DOPPLER
GEAR COMPANY

CDVS
TECHNOLOGY
AMERICA

EMAG

**ENGINEERED
ABRASIVES***

euro • tech

FOREST CITY GEAR

GEAR MOTIONS
Precision in Motion

GEARSolutions

Gleason

GREAT TAIWAN GEAR

GWJ
TECHNOLOGY

HELIOS
gear products

HOFFMANN
Hoffmann Filter Corporation • Your Partner in Precision

IPM
Precision Machining
& Gear Cutting

KLINGELNBERG

LIEBHERR

LOUIS BELET
Swiss Cutting tools

MTB Machine Tool Builders
TOOLING • REPAIRS • SERVICE



MOTION+POWER TECHNOLOGY EXPO

SEPTEMBER 14-16, 2021

AMERICA'S CENTER CONVENTION COMPLEX
ST. LOUIS, MO



American
Gear Manufacturers
Association



Power Transmission
Engineering

AGMA and its members are leading the power transmission industry into a stronger 2021. Join AGMA, the exhibitors you see listed here — industry leaders and experts in all sectors of manufacturing — in our commitment to MPT Expo and the global supply chain.

IF WE ARE ALL IN, WE ALL WIN.



»»» **LEARN MORE AT MotionPowerExpo.com**



- *Local Inventory*
- *Quick Delivery*
- *Great Service*
- *Top Quality*

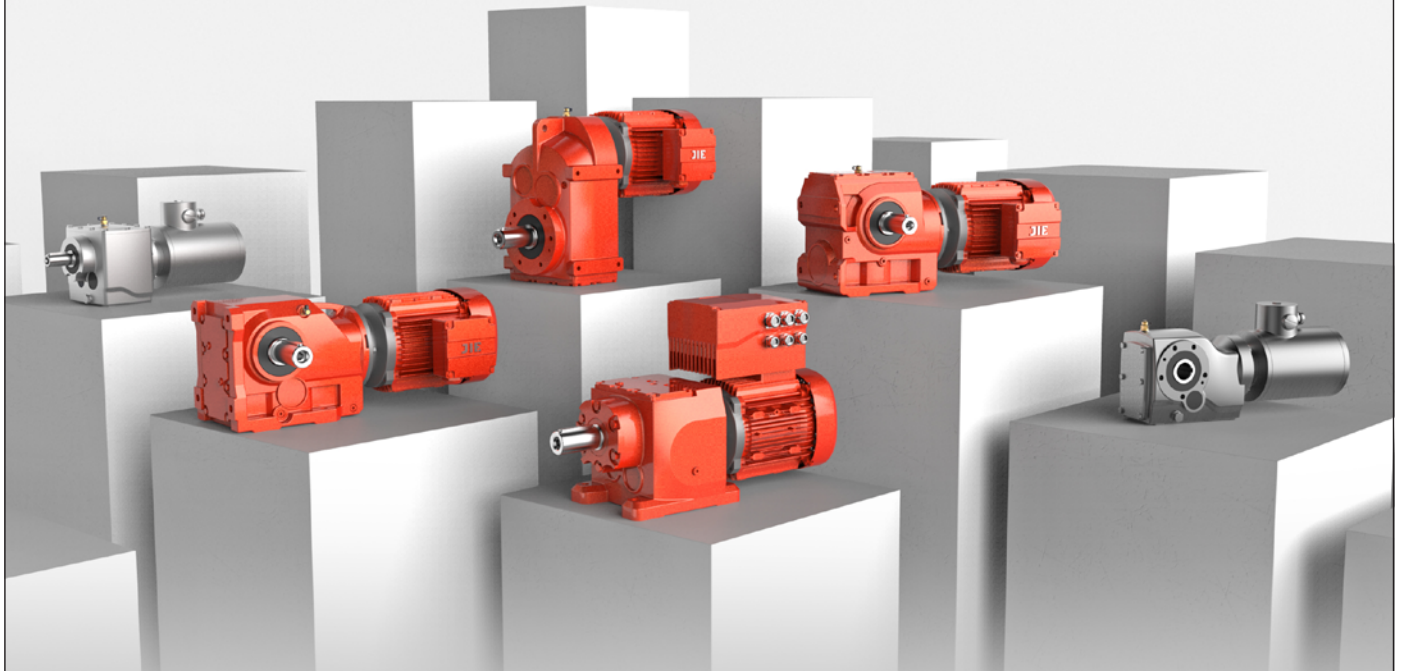

*Options are Helical Inline, Parallel Shaft, Helical Bevel and Helical Worm;
Available in both cast iron and stainless steel housing.*

www.jie-drives.com

Info@jie-drives.com

+1 630 580 9986

Subscribe TODAY

Power Transmission Engineering

BEARINGS

- MAINTENANCE
- COMPOSITE MATERIALS
- RACEWAY DAMAGE

BRAKES

BACKLASH IN MAMMOGRAPHY

SYSTEMS

AUTOMOTIVE

MEET OUR CONTRIBUTORS & BLOGGERS

www.powertransmission.com

IT's FAST. IT's EASY.
IT keeps YOU in the KNOW.

www.powertransmission.com/subscribe.htm

Precision Mechanical Components & Assemblies

Standard Industrial Components | Made To Print Parts

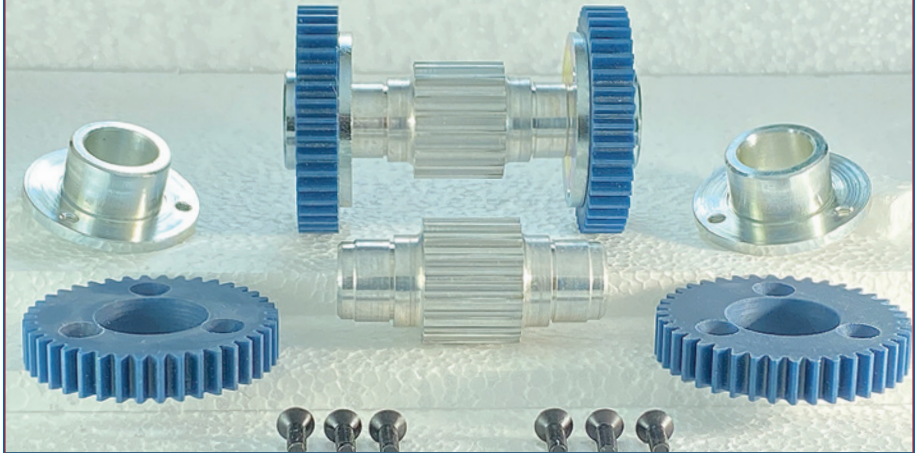

Gears, Pulleys, Shafts, Bearings, Couplings, Fasteners, Custom Gear Boxes Value Added Features and Services

- Engineering, Refurbishing & Design
- Custom Made To Print Parts
- Modified Standard Parts
- Assemblies & Sub-Assemblies
- Custom Mounts For Shafts
- Build Sub-Assemblies And Complete Assemblies
- Prototype Work

- ▶ Press bearings into pulleys
- ▶ Assemble bearings to shafts
- ▶ Set backlash on gears
- ▶ Assemble drive boxes
- ▶ Straightening
- ▶ Welding
- ▶ Kitting
- ▶ Plating / Custom Coating
- ▶ Heat treat

ADD

- Grooves • Flats • Keyways • Pins
- Threads • Staking • Pressing
- Testing



Nordex.com Sales@nordex.com Eng@nordex.com
Phone: (800) 243-0986 or Call: (203) 775-4877



B&R

MACHINE AND GEAR CORP

BRGEAR.COM

Inline Helical Speed Reducers

An extremely compact design provides highly reliable, space saving performance for the most demanding applications.



- 14 sizes, 1 - 75 HP
- Multi-stage Ratios
- NEMA, IEC, or Servo Motor Adapters
- High Efficiency & Low Backlash
- Multiple Mounting Configurations

DIEQUA
Corporation

diequa.com/pte 800-280-5402

High Performance Bevel Gearboxes

The Tandler Spiral Bevel gearbox is both precise and ideal for demanding applications where robustness and high torque density are required.



- 9 sizes
- 15 ratios
- Low backlash
- Customizable

DIEQUA
Corporation

diequa.com/pte 800-430-1439

www.sipco-imak.com

INDUSTRIAL GEARBOXES BUILT IN THE USA.

Helical Gear Motors

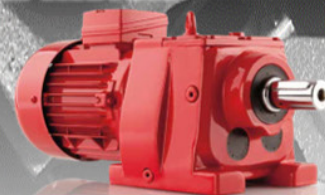

Planetary Gearboxes



Industrial Gear Drives



SIPCO i.Mak[®]

Gearboxes and Drives

281.480.8711

sales@sipco-imak.com

We Can Handle It!

The only totally U.S. owned manufacturer of Link-V-Belting

DuroDrive
LINK V-BELT

BDH BELTS

Ph 717-871-0994
www.bdhbelts.com

Fax 717-871-0995
sales@bdhbelts.com

**REGISTRATION
NOW OPEN**

Now accepting hotel reservations.



MOTION + POWER
TECHNOLOGY EXPO

GEAR
ELECTRIC
FLUID POWER

 **MOVING THE FUTURE.**

At MPT Expo, you'll see the full range of power transmission solutions, including hybrid solutions, utilizing mechanical power transmission, pneumatics, hydraulics, electric motors, and drives.

SEPTEMBER 14–16, 2021

AMERICA'S CENTER CONVENTION COMPLEX
ST. LOUIS, MO

**Your safety is our priority.
Regular updates posted at
[MotionPowerExpo.com](https://www.MotionPowerExpo.com).**

Formerly Gear Expo Owned by



American
Gear Manufacturers
Association

Field Weakening — What, How, and Why to do It

Don Labriola P.E.

Let's start with why field weakening is useful: it produces a wider speed range for a motor — with a constant torque at lower speeds and an almost constant power capability at higher speeds. This technique increases the motor power capability while also improving efficiency. There are many papers and patents discussing how to implement and optimize field weakening.

A synchronous motor produces a back-EMF proportional to the shaft speed of the motor and the strength of the magnetic field in the motor gap (field strength). A high torque constant motor also has a high back-EMF constant. (If the torque constant is in Nm/A, and the voltage constant is in V/Radian/Sec — the two constants are equal if losses are not included in the measurements).

Older motors and generators with a separate field winding could directly control the field strength and thus the back-EMF. Figure 1 (US2,925,550) shows how the field strength is intentionally adjusted to cause the resulting current to have a leading or lagging phase angle. The leading phase angle occurs when the motor is over-excited (back-EMF exceeds line voltage) and appears to be a capacitive load at the terminal frequency. The lagging phase angle occurs when the motor is under-excited, and appears to be an inductive load at the terminal frequency. This is the method used by a "synchronous condenser" used to adjust the VAR (Volts Amps Reactive) to improve the power factor (and reduce the power company charges) for larger factories.

But how does this get us to field weakening if we are using permanent magnets? Adjusting the phase of the drive current can allow the motor to be operated from a drive voltage that is less than the back-EMF of the motor. If there is magnetic material between the magnet and the gap, the intervening magnetic material can be made to oppose the magnetic field from the permanent magnet. The permanent magnet is not weakened, but the magnetic field in the gap of the motor may be reduced. This reduces both the torque constant and the voltage constant of the motor. The current is often characterized by the torque producing in phase current (I_d) and the weakening quadrature current (I_q), which may also be viewed as the current magnitude and phase. The peak current must be limited due to driver (inverter) ratings and motor heating.

To give a real example, the QuickSilver Controls SilverMax X34HC-2 motor has a back-EMF constant of 0.98 v/Radian/Second. At 500 rpm \Rightarrow 8.33 Rev/Sec \Rightarrow 52.36 Radians/Sec, the voltage across the terminals is 36.5 v peak. The motor

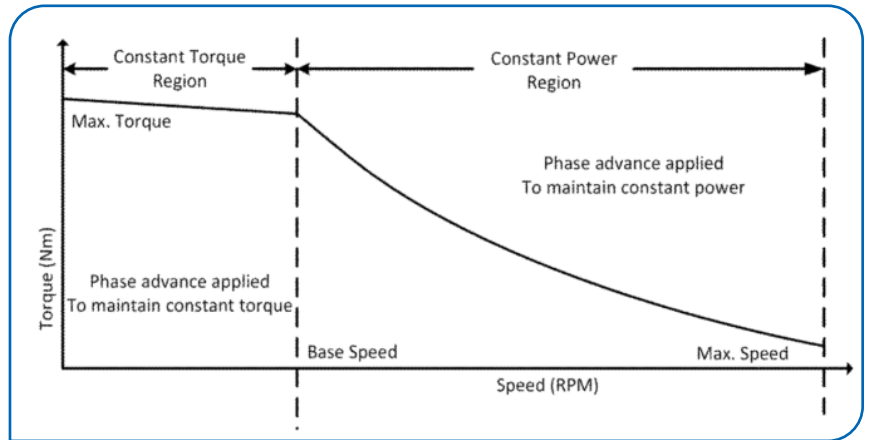

Figure 1 from US8866423B2.

torque curves show operation to 2,500 rpm with a 48 v DC supply, and almost 400 W mechanical output power. The open terminal back-EMF of the motor is some 136 v peak at 2,500 rpm! Without field weakening, this motor would be limited to approximately 880 rpm with a 48 v power supply and would have a much reduced torque at that speed.

Motor types: PMSM vs IPMSM: Permanent Magnet Synchronous Motor versus Interior Permanent Magnet Synchronous motor.

There are many variations of synchronous motor designs, but a common dividing line is whether the rotor magnets are directly facing the airgap to the stator or whether the magnets are mounted interior to the rotor with the flux directed to the gap through a highly permeable magnetic material. There are several factors that favor each of these designs. The surface mount magnets (Fig. 2) can minimize the inertia of the rotor, allowing for faster acceleration, and can offer simpler design for smaller motors. However, as the speeds and diameters increase, significant efforts may be necessary to affix the magnets to the rotor against the high acceleration; this is made more difficult when the adhesives must operate over wide temperature ranges. The servo motors typical of these face-mounted magnets typically have a fairly constant torque curve, but they only develop their maximum power near their maximum speed. Operation at half-speed will result in only half-power, and low speeds will show significantly lower efficiencies.

Interior permanent magnet synchronous motors were designed to overcome several of these issues. There are multiple approaches here as well, from the internal permanent magnet transverse flux motor (Fig. 4) to various low-pole-count rotor structures with interior magnets (Fig. 3). Common to the interior (or internal or buried) permanent magnet

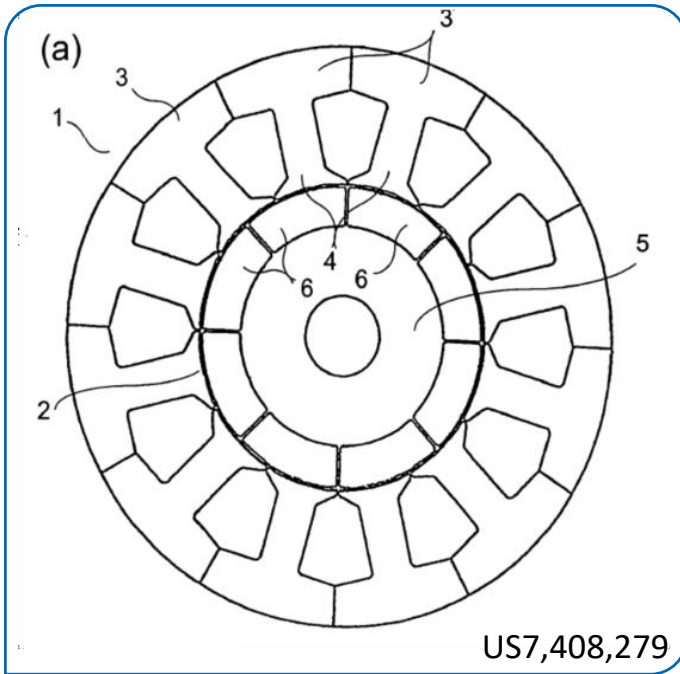

Figure 2 Face magnets.

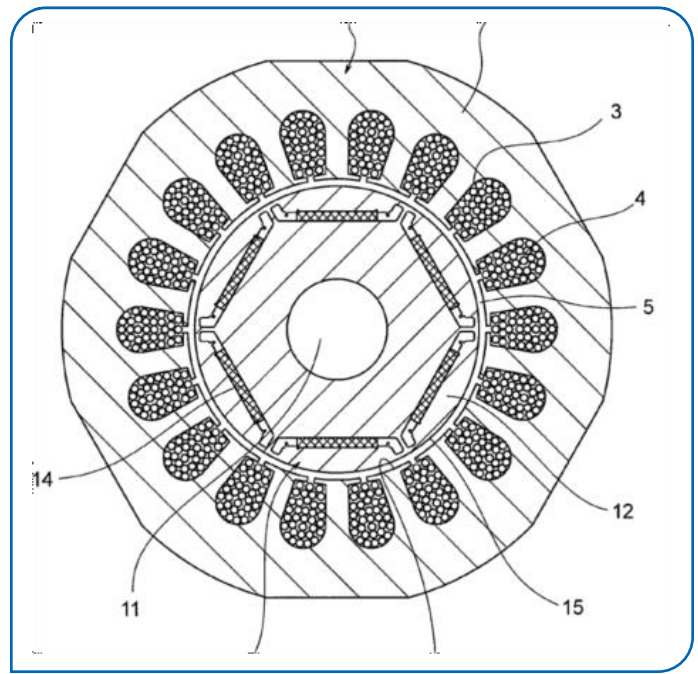

Figure 3 IPMSM US9,792,760.

designs are: 1) generally a reduction in the volume of magnet material needed, 2) added mechanical structure to support/protect the magnets, and 3) the ability to employ field weakening. Most designs also include the ability to improve low-speed torque by use of variable reluctance of the rotor in addition to the torque produced using the permanent magnets. (Fig. 3).

Figure 4 shows another form of internal permanent synchronous motor. When used open loop these are called step motors; used closed loop they are hybrid servo motors. The permanent magnet is placed between the two rotor caps, which each have 50 teeth in this example.

The ability to weaken the magnetic field for high-speed operation is used to significantly extend the power and efficiency curves of the motor. This improved performance has caused IPMSM motors to be increasingly used for improving efficiency—especially when used over a wide range of speeds.

In most of the articles and papers describing field weakening, the current is considered as an in-phase (I) and a quadrature-phase (Q) component. These are both oriented to the back-EMF generated by the windings on the stator when the rotor is rotated.

Field Weakening

For 3-phase motors, the physical currents are electrically 120 degrees apart, so they must be transformed to equivalent I and Q. For 2-phase hybrid servo motors (transverse flux synchronous motors), the physical currents are 90 degrees apart, so visualizing the effects of the I and Q currents is somewhat easier. When rotating, the two physical currents would need to also be combined into I and Q components, as the rotor rotates with respect to the stator. Again to simplify, the fig-

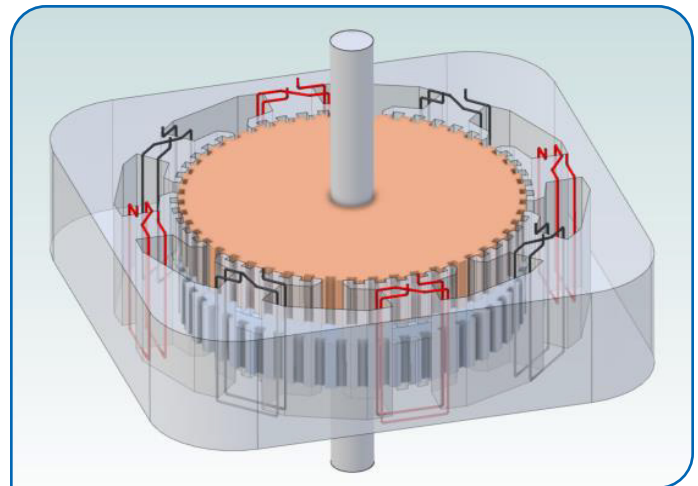

Figure 4 Internal permanent magnet transverse flux synchronous motor.

ures will show the rotor positioned so that the rotor angle is aligned with the stator such that the black windings represent the in-phase component (I), while the red windings are the quadrature component (Q). Again, this is only true for the instant in time that the rotor and stator have this alignment. The rest of the angles require transforming the physical currents into their I and Q components. Still, the snapshot in time is useful for visualization.

Figure 5 shows an end view of the motor. The arrows at the 9:00 position are just to show the rotor-stator alignment at this moment in time.

Figure 6 shows a permanent magnet located between the blue pole cap and the grey pole cap.

Figure 7 shows that the teeth in the blue pole cap are aligned with the gaps in the grey pole cap.

The windings at the top and bottom (12:00, 6:00) are both of the same phasing, i.e.— a positive current will cause the teeth of these phases to attract the north pole of the rotor, while those at the right and left sides have the windings connected in the reverse sense, and so will attract the south pole of the rotor. If the magnet inside the rotor (Fig. 6) is oriented so that the grey rotor cap is N and the blue rotor cap is S, then a positive current through the red windings will attract the grey teeth at 12:00 and 6:00 and while repelling the blue teeth. At 3:00 and 9:00 the stator windings have the opposite winding sense as at 12:00 and 6:00, so they will repel the grey teeth and attract the blue teeth; the result is a clockwise torque

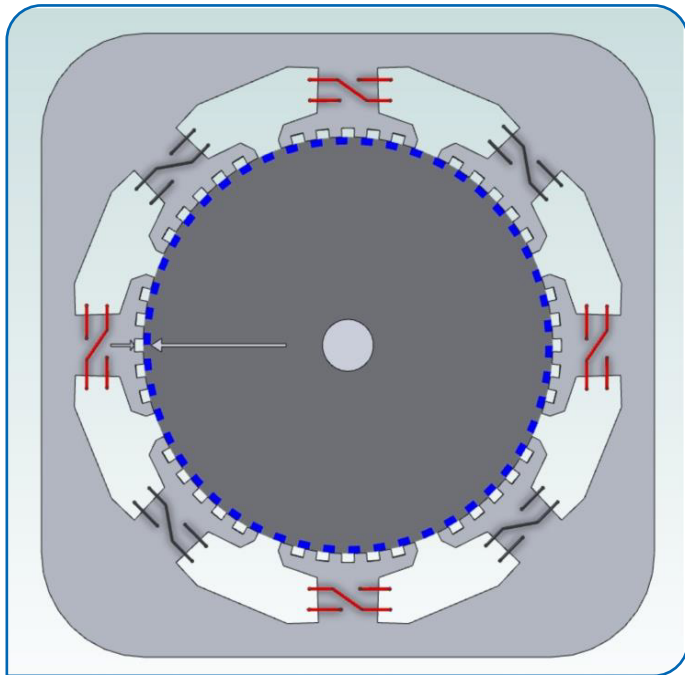

Figure 5 Motor end view.

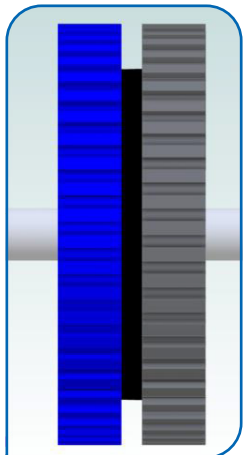

Figure 6 Rotor side view.

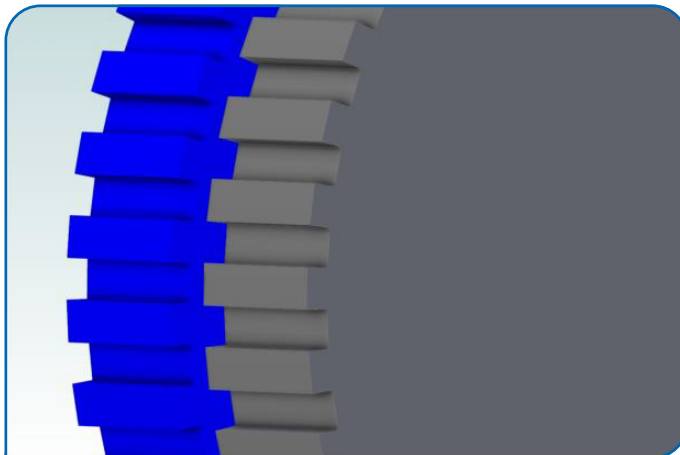

Figure 7 Rotor close up oblique.

production. We will call the red windings “Phase A.”

The four black windings on the diagonal stator poles, which we will call “Phase B,” for this given rotor to stator alignment, have teeth that are balanced with respect to the rotor teeth. Energizing this Phase B in either direction will not produce torque between the stator and the rotor. Let us assume that the stator poles at 1:30 position (upper right) and at the 7:30 position (lower left) attract a north pole when energized with a positive current, while those at 4:30 (lower right) and at 10:30 (upper left) are wound in the opposite sense and will attract a south pole when energized. One can see the teeth at 1:30 and at 7:30 are mostly coupled to the blue (south pole) of rotor, while those at 4:30 and 10:30 are best coupled to the grey (north pole). Thus energizing the B-Phase while the rotor is at this position will either aid the magnet field of the rotor (is the teeth have a net field that is of the same polarity as the permanent magnet — repelling the rotor teeth), or will buck some of the magnetic field of the permanent magnet if they have the opposite polarity (i.e. attracted) to the rotor end caps.

For this instant in time that the rotor has this position, the A-phase is acting as the torque-producing quadrature phase, while the B-phase produces no torque, but can be used to strengthen or weaken the effective field strength at the rotor teeth (gap)—which is the function of the In-phase component of the driving currents.

The function of A and B reverse their roles when the motor advances 1.8 degrees mechanical, as the teeth B-phase stator poles will now be in greatest misalignment to the rotor, while those of the A-phase will be symmetrical to the rotor teeth. The I (in-phase) and Q (quadrature) components of the drive currents, must then follow the rotation of the rotor as the motor is commutated, so the static position example given for phase A and phase B at the one given position is only useful at that one position. But the same torque producing and field strengthening or weakening does apply for I and Q components as the motor is rotating.

Hopefully this gives a good physical interpretation of how field weakening occurs in a motor with an interior magnet. If the magnets are on the face of the rotor, there is not carrying of the flux from the in-phase drive component of the stator field, as the permeability of a fully charged magnet is nearly the same as air (that is, its b-h curve is saturated and the addition of additional field strength from the electromagnets of the stator are unable to significantly change the flux through the rotor magnet(s).

The interior permanent magnet motor design of Figure 3 also has variable reluctance coupling (saliency) between the stator and the rotor, due to the gaps and structure within the rotor, and has similar ability to do flux weakening, although it may be a bit more difficult to visualize in this structure as compared to the transverse flux design. The face-mounted

magnet or Figure 2 does not have this saliency or variable reluctance; there is no high permeability magnetic material between the magnet and gap to allow flux to be captured and redirected from the I-phase component areas to the Q-phase torque-producing portions, and so this motor with face magnets is not normally able to be field weakened.

But Why Weaken the Field?

The motor generates back-EMF when the motor is in motion. The magnitude of the back-EMF is proportional to the strength of the magnetic field across the gap and the speed of the motor. The maximum speed of the motor is limited by the ability of the driver to force current into the motor windings. As the motor speed increases, the back EMF increases, and would eventually exceed the driver supply voltage. Using field weakening, the strength of gap field can be reduced, which reduces the back-EMF for a given speed. The lower back-EMF constant (torque constant) caused by the field weakening thus allows the motor to be run at a higher speed. Typically, this can double available motor speed.

The mechanical power available at the output of the motor (including the losses from friction and windage) is the back-EMF times the quadrature portion of the winding current (cross product to be more exact). The main copper loss is the current squared times the resistance. Thus, for a given current, the best efficiency comes when the back-EMF is as large as possible as compared to the resistive I-R drop. Having the ability to vary the field strength allows the back-EMF to be kept near the maximum (power supply voltage) over a fairly wide range of speeds, which allows the motor efficiency to remain fairly high over a fairly wide range of speeds. Figure 8 shows how the efficiency can be kept high over a wide range of speeds and over a wide range of voltages. The curves show the measured combined efficiency of the motor and the driver.

The field weakening also extends the available power curve, keeping the available power nearly constant over a two-to-one speed ratio, as seen in Figure 9. The higher available voltage allows for higher output power levels, as would be expected.

Hopefully this article has helped improve the understanding of how field weakening may be implemented in indirect permanent magnet motors—including hybrid servo motors—and why it is beneficial. **PTE**

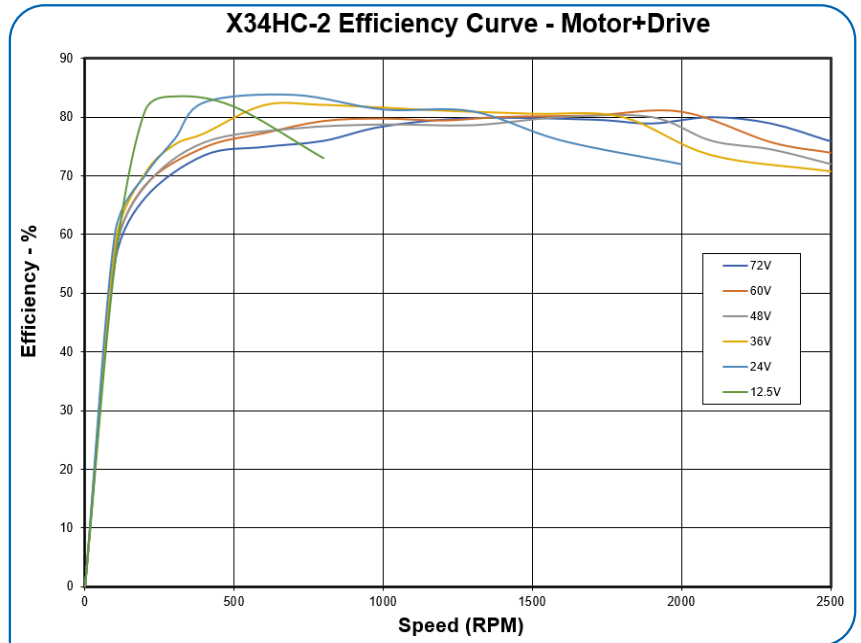

Figure 8 Speed rpm.

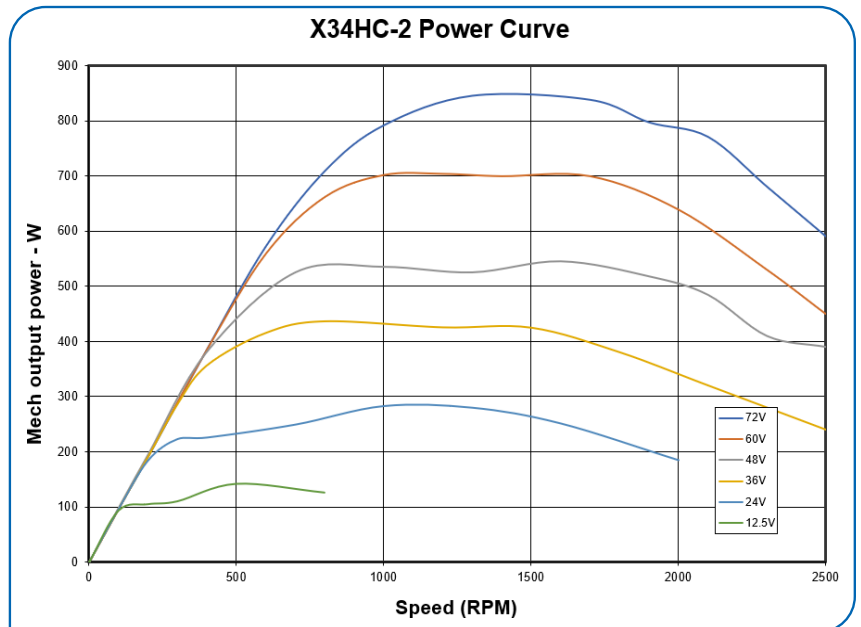

Figure 9 Speed rpm.

Donald Labriola P.E. is president at QuickSilver Controls, Inc. He has been working with step motors since high school, and has had these motors operating field-oriented closed loop control since 1984.



don_labriola@quicksilvercontrols.com

Joint Research and Simulation Software for an Optimized Rolling Bearing Friction Model

Benjamin Albert

For individual companies, and especially SMEs, research is a cost-intensive undertaking that is often associated with high risks. For this reason, many gear manufacturers rely on joint research with other industrial enterprises. This allows companies across the industry to save costs, reduce personal risk, and collectively benefit from new discoveries. FVA (Forschungsvereinigung Antriebstechnik e.V.) has been conducting joint research in the field of drive technology for more than 50 years to promote cooperation between organizations. With a research volume of more than 14.9 million euros, as well as 224 projects and studies in 2018 alone (Ref. 1), the FVA represents a true success story for its members.

The FVA-Workbench Bundles Hundreds of Research Findings in One Platform

Numerous calculation methods for the design and calculation of gearboxes, which have been valued by the industry for many years, have been developed and tested by leading research institutes within the framework of joint industrial research. It is impossible for a single engineer to possess this amount of research knowledge. Mastery of the contents of even a single research project can hardly be achieved in day-to-day business.

FVA GmbH develops the *FVA-Workbench* to provide unlimited access to these research findings. The software bundles the results and makes them available to the drive technology industry on a manufacturer-neutral and cross-sector basis, enabling companies to develop individual products at the highest level. This simple, high-performance software gives users access to research results in their daily business.

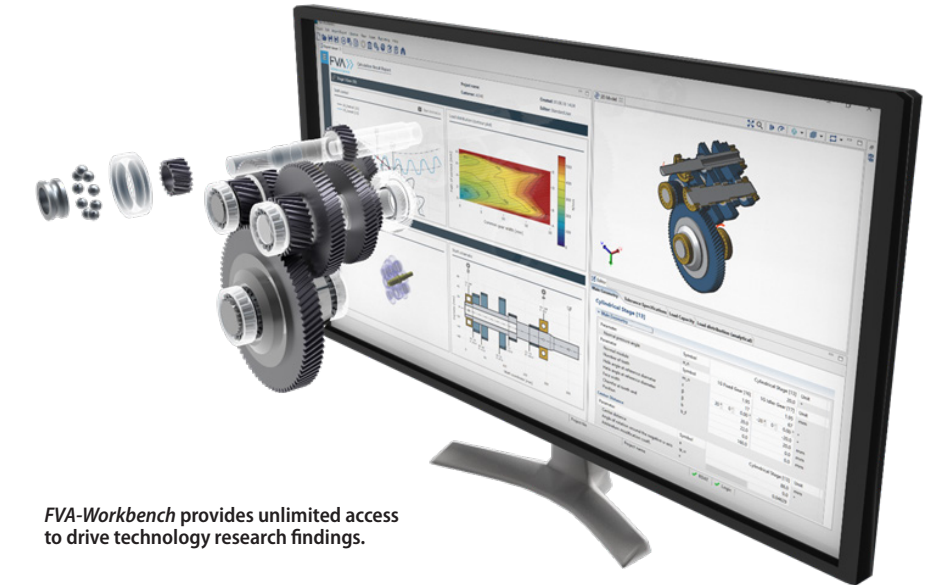

FVA-Workbench provides unlimited access to drive technology research findings.

Increased Efficiency for Reduced CO₂ Emissions

Easy access to extensive research knowledge is important to be able to quickly respond to changing regulatory and market conditions. There is no time to study hundreds of research journals and findings. For example, current legislation requires the reduction of CO₂ emissions. Above all, power losses must be reduced to save energy.

Reliable information on expected losses is essential for system manufacturers and gearbox users. Losses occur in all contacts with relative motion — especially in bearings and gears within gear units.

Extensive Documentation for Calculation of Power Losses

An unmanageable amount of literature, studies, and experiments exist for the calculation of power losses. A tool such as the *FVA-Workbench* that provides access to experimentally validated methods is essential, especially when a reliable statement about losses is a purchasing factor.

Power loss in gearboxes has been thoroughly investigated and documented. Loss considerations for the load-dependent and independent

shares of power losses are listed, experimentally proven, and precisely calculated in the research reports from FVA Research Projects 69 I through VIII, dating from 1989 to the present. For gears, a very good correlation can be observed to date, with real measurements from gear units. In the past, manufacturers' documented catalog methods were used for rolling bearings. In some cases, however, significant deviations from measurements have been observed (Ref. 2).

Estimation of Power Losses According to Palmgren

Palmgren is the most common method for estimating power losses. This often forms the theoretical basis for estimation of losses in a technical environment. For estimation according to Palmgren, power losses are divided into load-dependent and independent components. The two amounts are largely determined using bearing-specific coefficients. All relevant effects must be included in these coefficients. This makes the Palmgren model comparatively simple. However, additional effects which are particularly important in rolling bearing technology cannot be taken into account. Influences from

the type of lubrication or loads, for example from dominant tilting moments, cannot be represented. Therefore, an approach must be found in which the loss components are specifically listed for a design-dependent evaluation of bearing losses.

More Precise Calculations Thanks to IMKT, FZG, and FVA

A new approach for the characterization of rolling bearing power losses based on seven FVA research projects and five dissertations was developed at the University of Hannover IMKT under Professor Poll. As part of the project, the newly developed approach was tested and validated on the test bench at the FZG of the TU Munich. The *FVA-Workbench* simulation software brings this theory into practice.

The foundation of the methodology is a precise resolution of the rolling contacts in the bearing, the tribological characterization, and the allocation of the loss components to the loss mechanisms. The total power loss is the sum of the individual losses in the bearing. The following individual friction

components are considered: the hydrodynamic rolling friction M_{hydr} , hysteresis friction M_{irr} , splash losses $M_{plansch}$, differential slip M_{Diff} , and the rib friction M_{Bord} . Friction from cage contact and seals is neglected. This results in the following general relationship:

$$M_{total} = M_{hydr} + M_{irr} + M_{plansch} + M_{Diff} + M_{Bord} \quad (1)$$

The geometries of the rolling bearings are needed to calculate the contacts. The Breuer calculation approaches from FVA 184 are used to determine the internal load distribution on the rolling elements and the pressure distribution on the rollers. Thus, all influences from the gear system are fully considered (Ref. 4).

Different contacts and loss mechanisms occur in different rolling bearing designs. Formula (1) must be modified to take this into account. The ribs of deep groove ball bearings and angular contact ball bearings are ignored due to their design. For cylindrical roller bearings, on the other hand, the differential slip is ignored; however, if the bearing type has ribs, the rib friction is considered.

The calculation of the hydrodynamic rolling friction is based on the EHD theory. For this purpose, the bearing pressure across the contact length and contact width are resolved. The rolling element pressure can be derived from the stiffness calculation. All load components are considered in the stiffness calculation. The losses from irreversible deformation are determined by the material characteristics of the rolling bearings. The material damping influences the extent to which the irreversible deformation contributes to the total losses.

The splash losses in the rolling bearings are taken into account by many different influences. For a fast and powerful calculation, a CFD calculation is only of limited use. Therefore, the splash losses are determined based on the measurements from FVA 352. The losses can be derived from these measurements, depending on the oil level in the bearing and the bearing geometry.

With grease lubrication, splash losses are neglected. This is based on the assumption that the grease was completely pushed out of the contact during the first revolutions of the bearing. The contact is supplied with the base oil viscosity by a lubricant. Thus, splashing cannot occur.

For bearings with point contact, the differential slip must also be considered. In addition to the more obvious deep groove ball bearings and angular ball bearings, this also occurs in tapered roller bearings with rib contact. The Heathcote effect and the bore movement that results if a rolling element runs on a raceway with an operating pressure angle other than 0° are considered in this calculation.

The validation projects of FVA 364 IV and FVA 701 show an excellent accordance with the theory. Thus, significantly higher accuracy can be achieved compared to the factor-based catalog methods. These high-quality results are achieved by completely considering

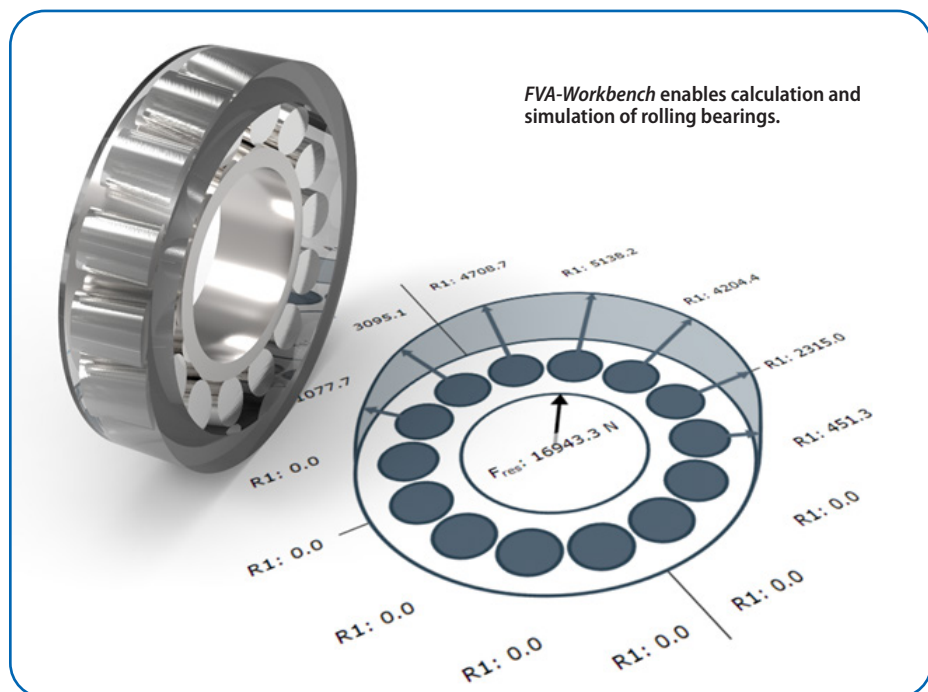

the pressure distribution and the environmental boundary conditions, such as tilting and bearing clearances.

The FVA-Workbench Brings Theory into Practice

In practice, precise statements regarding losses in the drive are required as early as the project planning phase. Every bearing and every auxiliary drive counts. With the new statements from FVA 701 I and III, manufacturers can now provide these statements and prove them with investigations from joint research. The *FVA-Workbench* supports engineers with an easy-to-use calculation model, comprehensive input consistency checks, and easy-to-interpret results. With the results from FVA 701 II, gearbox manufacturers are now able to provide reliable statements regarding losses in the offer phase and better describe the loss mechanisms.

FVA-Workbench — The Simulation Tool for Efficient Gear Design

The *FVA-Workbench* is a manufacturer-neutral software solution for the modeling, parameterization, and calculation of transmission systems. It bundles 50 years of research and development from the FVA expert network into a single platform and makes this accumulated knowledge directly available for industrial application. The software includes an impressive scope of calculations for all phenomena relevant to the design of drive systems. Gearbox systems can be developed in shorter cycles and in leading quality.

Seminars on the Cutting Edge of Research

For detailed insight into damage mechanisms and how loss calculation plays a decisive role, FVA Software and Service GmbH regularly offers seminars with well-known experts on the subjects of gearbox calculation and rolling bearing damage. In these seminars, you will learn about what makes a good design, how damage occurs, and how it can be avoided. At the same time, you can also make contact with FVA experts

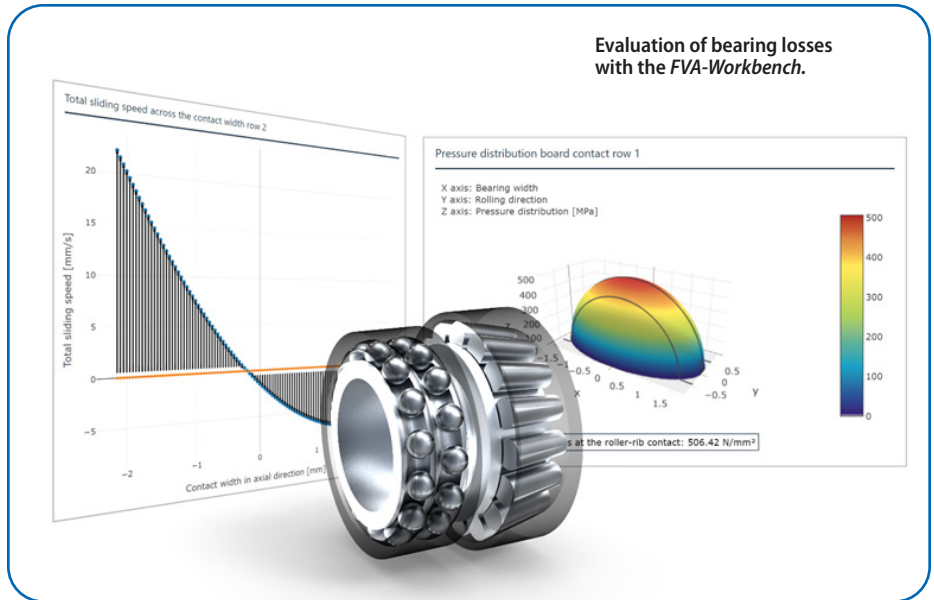

and other participants with similar interests. **PTE**

For more information.

www.fva-service.de

1. Forschungsvereinigung Antriebstechnik e.V. 2018 Annual Report
2. FVA 364 IV - Service Life - Industrial Gear Units - Rolling Bearings (Lager2 extensions)
3. FVA 382 - Influence of the Oil Level on the Friction Moment of Rolling Bearings with Line Contact
4. www.fva-service.de/en/fva-workbench/features/overall-system-calculations/

For Related Articles Search

bearings

at www.powertransmission.com



GREAT SCOTT!

It's the future!

OK, you blinked and missed last month's issue of *Power Transmission Engineering*. Fortunately, you don't need a DeLorean to travel back in time — just a computer and working fingers.

Hop online and visit www.powertransmission.com to view the entire magazine, including these exclusive features:

- Electrification Reimagined
- Problem with a Disc Pack Coupling
- Overview of Fretting Wear

...and much more!

www.powertransmission.com

Thomson Case Study: Smart Electric Actuators Give the Marching Arts a Lift

The capacity of a 53-foot semi-trailer is roughly 3,500 cubic feet, which is more than enough to carry the furnishings of two large houses. For those tasked with loading and unloading such vehicles, safe, reliable and easy-to-operate loading ramps can be invaluable. And when those people are not professional movers but parents of marching band performers, the need to facilitate the process is even more pressing.

Clubhouse Trailer Company (“The Clubhouse”) of Edmond, Oklahoma, is the only company that specializes in building custom trailers that marching bands use to haul equipment from performance to performance. Up until recently, they had been using hydraulic cylinders to deploy and stow loading ramps, but recently switched to electric actuators. In doing so, they are demonstrating logistics efficiencies and improvements that have implications well beyond the marching arts.

Taking the field

A typical marching band could have a hundred or more members, which translates to roughly a million dollars worth of equipment. In season, they may have up to 20 performances annually and sometimes need to pack up and move to different locations on the same day. Adding to the challenge is the fact that loading teams are comprised of volunteer band parents like Jeff Hadley and Drew Taylor, co-founders of The Clubhouse.

In 2010, their children’s high school was desperately in need of a trailer, so they decided to build one for them, using a refurbished semi-trailer. The result was stunning, and as neighboring school districts saw it arriving at band competitions, they wanted one too. At first, Taylor and Hadley reluctantly took on other projects, but eventually realized the full potential of their side project. In seven years, what was once a two-man weekend-and-evening hobby



Figure 1 A typical semi-trailer for marching bands, such as this one built by The Clubhouse for Edmond Santa Fe High School, carries a million dollars worth of equipment.

became a full-time business and the fastest-growing, privately owned company in Central Oklahoma.

Ramping up

The first Clubhouse trailers used two manual ramps that slid out from storage channels beneath the trailer floor and sat side by side for operation. As the business expanded to meet the requests of their growing customer base, Taylor and Hadley added folding ramps powered by hydraulic cylinders. The ramps were in two segments. Hydraulic cylinders anchored to the trailer floor raised and lowered the ramp, while two cylinders located on the underside of the ramp controlled the ramp extension section. When loading was complete, the cylinders pulled the ramp back up and stowed it standing up in the back of the trailer, ready for travel to the next deployment.

While hydraulic controls worked well, the growing business demanded more innovations, and The Clubhouse founders felt that hydraulic technology was limiting them.

“We used hydraulics because that was where the world was,” said Hadley. “They served us very well, but as the

number of projects increased, we began to see performance inconsistencies in things like handling temperature extremes, trailer settling and weight distribution.”

An Efficient Switch

“Our initial search for an alternative came up dry until we contacted Thomson,” Hadley continued. “That is when we had our ‘aha’ moment. We realized that most of the functionality that we were looking for was not something you get from an actuator itself but in the functionality that you can build into your application with a smart actuator.”

For his next project, Hadley replaced the hydraulic cylinders that controlled the ramp with four Thomson Electrak HD electric linear actuators. These controlled the overall ramp movement—extending up to 28 inches—while the two that extend the ramp fold section reached 18 inches. (Figure 2)

Optimizing ramp performance

Switching to electric actuators immediately eliminated the extreme temperature response issues that they were running into with hydraulic cylinders.



Figure 2 Four Thomson Electrak HD electric actuators (two on the floor and two below the ramp) allow The Clubhouse to safely control trailer ramp movement.

“One week a band might be using the trailer in a cold northern climate, but the next week headed south for the Rose Bowl Parade,” said Hadley. “Such temperature extremes affect the fluid and can impact ramp folding, sequencing and deployment time, which requires frequent adjustment. Electric actuators are not subject to such variation and provide consistent operation, regardless of the environment and ambient temperatures.”

The electronic controls also made it easier to secure the ramp during travel or active loading. Each section of the ramp weighs 250 pounds and must be secured during both transport and operation. With hydraulic cylinders, once the power is off, there was still creep from seal leaks in these components, but the Electrak HD actuators have electronic hard-locking functionality that eliminates undesirable motion.

Smooth moves

The Electrak HD’s onboard electronics, combined with CAN bus networking, ensure consistent and synchronized movement of the ramp actuators. (Fig. 3)

“As the ramp deployment starts, the segments have to kick out to get things started and then flatten out over the move,” said Hadley. “With the hydraulic cylinders, each operates independently, so if there is any shifting of variation in the cylinder performance itself, you run the risk of the ramp buckling or twisting. The Thomson synchronization software harmonizes actuator operation, telling each actuator when to

move to maintain balance. The same thing happens when it comes back up, and overall, the synchronization feature speeds up the whole ramp operation.”

Maintenance benefits

Eliminating hydraulic fluid itself also has many benefits. The Clubhouse team had been spending many hours hand-bending and mounting the stainless steel tubing necessary to bring the fluid to the hydraulic cylinders. The lightweight tubing is also subject to being crushed by instruments incorrectly strapped to the walls and, subsequently, hazardous leaks. With the Thomson actuators, all of the wiring is protected by nesting in the wall panels, under the floor or through the ceiling.

“With the Thomson actuators, we have reduced installation time by about 75 percent, and we don’t need band parents searching for hydraulic leaks from fittings during start-up,” said Taylor.

Innovating for convenience

As they became familiar with the capabilities of the Electrak HD actuators, Taylor and Hadley began adding functionality to their trailers in ways they had never anticipated in their initial search for an alternative to hydraulics. Electric actuators have made it easy for them to offer customers new, unique options for any trailer project, including:

- **Moving Floor** - The Electrak HD’s synchronization capability enables a section of the second floor to be raised smoothly to any



Figure 3 The synchronization feature of the Thomson Electrak HD helps coordinate smooth, safe and quick ramp operation.

desired height within a 16-inch range, allowing packers to optimize overhead and underfloor space. (Figure 4)

- **Power-retractable rear stairs** – While previous rear stairs were spring-retracted, new, electric-driven stairs are easier and safer. (Figure 3)
- **Power-retractable front stairs** – Once they had solved the retractable design for the rear stairs, replicating it for the front of the trailer made for a convenient new accessibility option. (Figure 4)
- **Tubavator** – This electric lift extends out from an open street-side door of the trailer to simplify the loading of the band's heaviest equipment, such as tubas, which can each weigh up to 85 pounds.

Partnering for innovation

In addition to product functionality, Hadley credits Thomson engineers for solving installation design challenges and helping The Clubhouse program the various smart features of the Electrak HD.

“When we were having trouble fitting an actuator assembly to the wall, Thomson came back with a design that rotated the motor 90 degrees,” said Hadley. “To enable us to mount actuators within our ramp frames while still connecting to existing mounting points, they added a four-inch extension to the actuator tube. To allow us to remove a damaged actuator, they gave us a way to unscrew the connector plug and leave the wiring harness in place for the next actuator. Whatever we needed, they were there with solutions.”



Figure 4 Actuator synchronization enables operators to raise this moving floor up to increase storage space.

Marching on

So far, The Clubhouse has deployed five different configurations of the Thomson Electrak HD actuator on various projects. One trailer, for example, is using 11 actuators — powering the ramps, front stairs, rear stairs, moving floor and Tubavator. The Clubhouse continues to build about 50 trailers per year, and with thousands of active high school, college and drum corps programs in the U.S., it is unlikely that their business will do anything but grow.

No one knows for sure which direction future band trailer innovations will take, but Hadley and Taylor are quite certain that electric actuators will be doing the heavy lifting. **PTE**

For Related Articles Search

actuators

at www.powertransmission.com



Figure 5 Electric-driven stairs have opened up new, safer accessibility options for The Clubhouse trailers.

MISSING A PIECE?

We've got you covered! Go to powertransmission.com to see what you missed in last month's issue, plus another fourteen years of back issues, industry and product news, and more!

In last month's issue:

- Electrification
- Couplings
- Bearing Reliability

... and more!

Power Transmission Engineering

Shell

SELECTS SIEMENS POLARION SOFTWARE FOR CAPITAL PROJECTS DATA

Siemens Digital Industries Software recently announced that Royal Dutch Shell has selected *Polarion Requirements* software as the foundation for managing and streamlining the flow of requirements across Shell's global Capital Projects ecosystem. Shell will leverage Siemens' *Polarion* to accelerate development of its digital enterprise as they further transition from document-centric communications to data-driven execution. This will improve the efficiency and flow of digital project data and integrated requirements throughout the Shell supply chain.



Shell is using *Polarion*, a contextual tool within Siemens' *Xcelerator* portfolio of integrated software and services, to enable highly effective and transparent collaboration between its project development teams. The software connects Shell's project teams as they apply Systems Engineering techniques to rapidly and efficiently gather, author, approve, manage, and audit requirements for complex systems across the entire project lifecycle.

"Shell invests billions of dollars each year in new capital projects, Powering Progress in the energy transition and working toward our climate target of being a net-zero energy emissions business by 2050, in step with society. We need trusted partners to do this — which is why we are working with Siemens on a robust, comprehensive and innovative requirements solution," said James Haug, general manager for systems engineering at Shell. "The *Polarion Requirements* software will be the lynchpin technology for advancing our digital enterprise. As we standardize on and deploy *Polarion* globally, we look forward to enhanced efficiencies and lower costs for Shell and for our supply chain and project ecosystems."

Siemens and Shell worked collaboratively to ensure that the *Polarion* solution provided was configured to accelerate Shell's digital transformation goals. The strategy involved atomizing corporate specification documents into data using *Polarion* to automatically create status reports, documents and workflows that subsequently improve the real-time availability of relevant standards content and requirements across the organization. As a result of the initiative, requirements previously managed in documents

are now available as data to be modified and tracked, via a user-friendly collaborative interface, to support and deliver greater efficiency in engineering workflows across the project development lifecycle. Shell quickly expanded the use of *Polarion* to a substantial number of projects globally within the first year, following the technology's initial deployment.

"Siemens is pleased to help one of the world's foremost energy firms develop and deploy a modern, world-class digital enterprise based on the management and coordination of requirements data and other critical initiatives," said John Nixon, senior director for the energy and utilities industry at Siemens Digital Industries Software. "By implementing a unified approach to requirements management that connects all project development processes with their engineering artifacts, and improving the collaboration between the teams that originate, manage and review them, *Polarion* is helping Shell and its supply chain partners reduce their total cost of ownership, improve regulatory compliance, and accelerate time-to-value on assets."

www.sw.siemens.com

Worldwide Electric

WELCOMES VICE PRESIDENT OF BUSINESS DEVELOPMENT

WorldWide Electric is pleased to announce the addition of **Michael Proffitt**. Proffitt joined the team as vice president of business development in January 2021. Previously, he was a founding partner, principal, and CEO of Advanced Compliance Solutions, a customer-centric provider of compliance testing and certification services for electronic products. When TÜV SÜD America acquired Advanced Compliance Solutions in 2017, Proffitt became director of service line operations. Earlier in his career, Proffitt spent many years with Siemens and obtained a diverse range of experience in operations and marketing in the industrial controls business unit, OEM Sales, and channel management. A native and current resident of the Atlanta metropolitan area, he earned an MBA in Finance from Georgia State University and a bachelor of arts degree in English from the University of Georgia.



As vice president of business development, Proffitt is tasked with strengthening WorldWide Electric's motor controls and specialty products businesses. He will focus on continuing to cultivate the customer-centric approach that has earned and retained WorldWide Electric's strong and loyal customer base. Proffitt describes WorldWide Electric's commitment to customer service as being "in the company's DNA." He plans to build on that commitment by improving product selection, customer support tools, and sales processes in the motor controls division while also promoting accessibility of technical support services. Proffitt's work will contribute to WorldWide Electric's objective of consistently

exceeding customer expectations to make working with WorldWide Electric easy, convenient, and smart.

Reflecting on his first few months with WorldWide Electric, he already recognizes the people as the company's greatest asset. When describing the employee culture, Proffitt said, "The team is completely aligned around a common goal of being the best in our market at delivering solutions to our customers. I am pleasantly surprised at how focused we are on exceeding our customer's expectations in the area of service. This company is best in class."

Worldwideelectric.net

Bosch Rexroth

CELEBRATES INDUSTRY 4.0 MILESTONE

Industry 4.0 is coming of age. What began at Hannover Messe in 2011 as a "pioneering German project" has now gained global traction — thanks in part to groundbreaking work by Bosch. The aim is for connected manufacturing to optimize itself automatically, making it economical to produce customized products in batch sizes even as small as one.



Since 2012, Bosch has been systematically leading factories — both its own and those of its customers — into this new industrial age. This commitment is paying off: over the past ten years, the company has generated more than four billion euros in sales with Industry 4.0. In 2020 alone, Bosch generated sales of more than 700 million euros with connected manufacturing solutions.

"We recognized the potential of Industry 4.0 early on and are pioneers in this field. Now we're reaping the rewards," says Rolf Najork, the member of the Bosch board of management, responsible for industrial technology.

The use of Industry 4.0 in the company's own plants is also paying off. Bosch is combining intelligent software for production control, monitoring, and logistics planning into a manufacturing platform of its own. This connects to a larger database that simplifies and improves tasks such as AI analyses for fault detection. The roll-out of the new Bosch manufacturing and logistics platform will start at the end of 2021.

"We offer our roughly 240 plants a standardized 'Industry 4.0 toolbox,' which can be expanded and deployed as needed," Najork says.

Bosch believes this will save it almost one billion euros

over the next five years, following an investment of around 400 million euros.

The beginnings: Bosch does pioneering work on Industry 4.0

Back in 2011 at Hannover Messe, scientists presented an idea that broke with convention. Rather than have people adapt to machines, they turned things around. The vision here was of products that actively involve themselves in their manufacturing, navigate themselves through the production process, and communicate with humans and machines. It was the birth of Industry 4.0 — Bosch is one of its founding fathers.

In 2012, the company took over the chairmanship of the newly established Industry 4.0 working group to further develop the German government's high-tech strategy. Bosch became a leading provider and a leading user of Industry 4.0, not only testing this modern form of manufacturing in its own plants, but also bringing proven solutions to the market. The Bosch plants in Blaichach in Germany, Anderson in the U.S., and Wuxi and Suzhou in China were pioneers in this domain and have been the recipient of multiple awards for their innovative concepts, including the designation of "lighthouse factories" by the World Economic Forum.

At the same time, one thing soon became apparent: "The only way to tap the full potential of Industry 4.0 is collectively and globally. Humans and machines need to 'speak the same language.' This requires international, cross-company standards," Najork says.

Bosch worked together with other companies to develop OPC Unified Architecture (OPC UA), a machine language for Industry 4.0 that standardizes access to devices and systems and enables manufacturer-independent data exchange. There was also increased collaboration between organizations such as Plattform Industrie 4.0 and the Industrial Internet Consortium, with Bosch an active leader in both. Alliances became an integral part of Industry 4.0.

And today? Interest is still high, but too few companies are consistently gearing up for Industry 4.0: "Pilot projects are a good approach for trying things out and getting ideas out there. Now it's time to up the tempo: we need to make Industry 4.0 the norm," Najork says. Bosch uses its own academies and training courses to train associates for Industry 4.0 and also makes this offering available to customers. Najork is convinced that "Industry 4.0 is not an end in itself. It's a way to maintain competitiveness. In the future, nothing will be possible without digitalization."

Bosch projects deliver measurable benefit: connected solutions increase productivity by as much as 25 percent, boost machine availability by up to 15 percent, and reduce maintenance costs by as much as 25 percent. "If we want to exploit the potential of Industry 4.0, we have to move away from isolated solutions. Technical systems that work only within their own boundaries inhibit progress," Najork says.

In Bosch plants, there are now over 120,000 machines and over 250,000 devices such as integrated cameras or robots connected. Some 22,000 machine controllers alone are connected via the Nexeed software for Industry 4.0 developed by Bosch Connected Industry. Founded in 2018, this operating unit has already supplied software to more than half of Bosch's plants and more than 2,000 production lines.

In addition, around 100 international customers rely on Nexeed — including BMW, Sick, and Trumpf. Hardware and software are growing ever closer together.

At Hannover Messe, Bosch Rexroth presented its ctrlX Automation platform. Based on app technology and web engineering, this open, 5G-enabled control technology enables co-creation. The idea behind it is for users to either use apps provided by Bosch Rexroth and third-party providers, or to develop apps themselves and share them with other companies within an ecosystem. “By making developments participatory,” Najork says, “we can create network effects and let ideas take wing.”

“Our focus is on harnessing and combining the power of different technologies. Bosch is becoming an AIoT company. We’re bringing artificial intelligence and the internet of things together,” Najork says.

www.boschrexroth-us.com

Cyient

LAUNCHES SERIES OF INDUSTRY 4.0 SOLUTIONS

Cyient, a global engineering and digital technology solutions company, announced the launch of its INTELLICYIENT suite of Industry 4.0 solutions that will enable digital transformation for industries that draw significant value from their assets such as manufacturing, industrial, aerospace, automotive and off-highway, utilities, and mining and natural resources. INTELLICYIENT was launched by [Anand Parameswaran](#), senior vice president and global business head, Cyient Digital, at Hannover Messe 2021—the Olympics of Technology—where [Karthik Natarajan](#), chief operating officer and president, Cyient, delivered the keynote on Resilient Manufacturing.

Enterprises implementing Industry 4.0 stand to create an economic value of US\$3.7 trillion by 2025. The Industry 4.0 spend is poised to grow at over 20% and systems integration, application development, and data services are expected to be the key technology focus areas.

The most successful Industry 4.0 solutions will be the ones that bring domain knowledge, depth of technological expertise, and engineering excellence and understanding of business operations. These have been the unique strengths of Cyient, which makes it a partner of choice across its Fortune 500 customers globally.

“Cyient has leveraged its investments in the latest digital technology capabilities, and its three decades of experience in engineering and geospatial offerings for asset-intensive



industries to design its INTELLICYIENT solution portfolio,” said Parameswaran. “With six digital solutions, powered by the interplay of nine technology studios, and our strong partner ecosystem, INTELLICYIENT will help enterprises globally achieve the full potential of digital transformation with IT-OT convergence. We aim to focus on the four key themes of smart automation, intelligent supply chain, end-to-end visibility of workflows and assets, and next-gen workforce solutions that are driving Industry 4.0 adoption.”

Akshat Vaid, vice president, Everest Group, who moderated a panel discussion on digital transformation, said, “Digital engineering has become all-pervasive, contributing over 23% to global ER&D spending. Within manufacturing, it manifests as Industry 4.0—the transformation of cyber and physical systems on the back of digital themes for enhanced visibility, control, and autonomy. Industry 4.0 investments have been rising steadily, and the COVID-19 crisis has provided an additional impetus as enterprises look to enhance manufacturing resilience. In effect, enterprises are no longer viewing this spend as discretionary but rather as an avenue for driving business resilience and competitiveness. They, however, struggle with a shortage of capabilities, organizational complexity, data integration, and speed of implementation when it comes to transformation-at-scale. This has led to a rise in outsourcing with third-party vendors offering services across consulting, development, integration, and management of existing deployments.”

To take on this growing opportunity, Cyient Digital, as a leading solutions and services provider, is scaling up its capabilities by investing in talent, solutions for specific use-cases, ecosystem partnerships, and the relevant infrastructure of labs and centers of excellence.

[f.hubspotusercontent40.net/hubfs/5724847/2021/intellicyient/Intellicyient.mp4](https://www.hubspotusercontent40.net/hubfs/5724847/2021/intellicyient/Intellicyient.mp4)

Schaeffler

NAMED ONE OF THE 50 SUSTAINABILITY AND CLIMATE LEADERS BY THE U.N.

The Schaeffler Group has been selected as one of the 50 Sustainability & Climate Leaders worldwide on the occasion of the 75th anniversary of the United Nations (UN). The common objective of this initiative is the achievement of the 17 goals for sustainable development set by the United Nations.

“For us, the appointment of the Schaeffler Group by the UN as one of the Sustainability & Climate Leaders is not just recognition of the work we have done to date, but both an incentive and an obligation to continue implementing our sustainability strategy with the utmost consistency,” said Klaus Rosenfeld, chief executive officer of Schaeffler AG. “As part of this impressive initiative, we will do everything in our power to realize our sustainability and climate targets and thus make our contribution to achieving the 17 sustainability goals of the United Nations.”

A prerequisite for the admission into the 50 Sustainability & Climate Leaders is a clearly defined sustainability strategy and corresponding corporate objectives. As a corporate value,



sustainability has been firmly anchored in the Schaeffler Group's activities for many years and is an integral component of the corporate strategy. "Sustainable corporate success to us means assuming ecological and social responsibility — in production, through the use of our products, and with the involvement of our suppliers," said Corinna Schittenhelm, member of the board of managing directors of Schaeffler AG with responsibility for HR and sustainability.

Schaeffler was convincing in the selection process and now represents the automotive and industrial supplier sector in the DACH region (Germany, Austria, Switzerland). For the Schaeffler Group, it is not only the ecological footprint of its own production facilities that plays a major role. The development and production of technologies for the optimal use of renewable energies is also an important contribution to climate protection. Schaeffler's components, systems, and service solutions make specific contributions to sustainable changes in a wide range of industries — for example, in the electrification of the powertrain for vehicles or in the manufacturing of large-sized bearings for wind turbines.

www.schaeffler-sustainability-report.com

AD

SECURES THIRD CONSECUTIVE TOP WORKPLACE AWARD

For a third straight year, AD has been recognized as a Top Workplace in the greater Philadelphia region based on feedback from its annual employee engagement survey. The anonymous survey uniquely measures drivers of engaged cultures that are critical to the success of any organization, including how well employees are aligned with company goals and objectives, feel they belong and are valued, get support and attention from their manager, and believe the organization operates effectively. AD partners with employee engagement technology partner Energage, LLC to administer the survey.

"Earning this distinction is deeply meaningful, and even more so in a pandemic year that brought added stresses, uncertainty and distance between us," said AD's Chairman and CEO Bill Weisberg. "Achieving three straight years of this award is only possible because our executive committee, leadership team, HR team, managers, associates, and Great Place to Work Committee are all dedicated to constantly improving and learning from one another." Weisberg points to The AD Way as a major driver of the company's award-winning culture.

"Practicing our 34 fundamentals, the foundational behaviors that guide our interactions, creates a healthy environment that allows us to attract and retain amazing talent, and deliver unparalleled service to the organization's community of members and supplier partners," Weisberg said. "Our associates put in the extra effort."

Senior Vice President Neil Cohen, who leads AD's HR effort, said, "This award is special because it's based purely on our associates' feedback. It's a strong signal that they are engaged, willing to share their perspectives, and have skin in the game to help us celebrate our strengths and make continuous improvements."



Energage CEO Eric Rubino shared his thoughts on the value of the feedback. "When you give your employees a voice, you come together to navigate challenges and shape your path forward. Top workplaces draw on real-time insights into what works best for their organization, so they can make informed decisions that have a positive impact on their people and their business."

www.adhq.com

VELO3D

ADDS KRAUSE TO BOARD OF DIRECTORS AS AUDIT COMMITTEE CHAIR

VELO3D Inc. has announced the appointment of renowned business leader **Stefan Krause** to the company's board of directors as audit committee chair.

With more than 30 years of experience working at some of the most recognizable and successful companies in the world, Krause has built a singular career that previously included a chief financial officer (CFO) role at BMW — where he was the youngest ever to hold the position and a member of the management board. Krause then took on a similar role at Deutsche Bank, earning himself a reputation as one of the world's top CFOs. He also previously served as chairman of Rolls Royce Motorcars, Postbank AG and BHF Bank. He has been in the supervisory boards of Rocket Internet and Allianz AG.



Krause has also been involved with multiple startups during his career and has been CEO and co-founder of electric vehicle maker Canoo.

“Stefan’s international business background, his expertise in branding and go-to-market strategy and his deep experience managing public companies make him a welcome and valuable addition to our board as VELO3D prepares for life as a public company,” said Benny Buller, founder and CEO, VELO3D. “His presence will help VELO3D continue our accelerated growth at scale and speed adoption of our full-stack metal AM solution, freeing the most imaginative engineers on the planet to build the impossible.”

Last month VELO3D announced plans to merge with JAWS Spitfire Acquisition Corporation and become a public company.

The company also previously announced a U.S.-wide distribution partnership with GoEngineer, and has said it plans to expand commercial operations in Europe, while establishing strategic partnerships in both Europe and Asia, demonstrating the company’s focus on supporting visionary aviation, energy, space and industrial customers all over the world. Current customers include Chromalloy, Honeywell, Lam Research, and Primus Aerospace.

“With truly unique capabilities setting it apart from others in the AM space, VELO3D is actually delivering on 3D printing’s previously unfulfilled promise of innovation and design freedom,” said Krause. “This is due to a relentless focus on pushing the limits of manufacturing technology and helping customers design and build the parts they need without compromise. I’m looking forward to working with Benny and the team to help companies become more agile and innovate faster.”

www.velo3d.com

Nordex

RECEIVES AS9100D AND ISO 9001:2015 ACCREDITATION

Nordex, Inc. recently announced the establishment of a quality management system for AS9100D & ISO 9001:2015. The company is involved in the manufacture, distribution, assembly and refurbishing of catalog and non-standard high precision mechanical/electro-mechanical components and assemblies such as bearings, couplings, gears, ball slides, enclosed geartrains and related instrument grade power transmission components and assemblies for medical laboratory and industrial analytical instruments, factory automation, semiconductor and aerospace OEMs.

“Nordex has been in business for more than 60 years. We have accomplished this through continuously striving to improve our business so we can better serve our customers. AS9100D certification helps Nordex to be a better company, through improving our quality processes and reducing our costs—this helps us to provide more value to our customers and ensures we always deliver the high-quality products they have come to expect,” said Dan Agius Jr., CFO and part-owner of Nordex, Inc.



Nordex growing strong over three generations.

It’s not just the quality department that has been improved by AS9100 certification, but Nordex’s entire manufacturing operations, according to Agius.

“Through our heightened quality procedures, we are running more efficiently and finding and correcting potential problems very early on in our manufacturing process. Obtaining AS9100D certification has helped provide us with the tools to do this by developing improved risk mitigation strategies. This helps us to meet and exceed our customer’s needs when it comes to quality and on-time delivery,” he added.

With the evolution of the power transmission industry, Nordex has been able to thrive thanks in part to quality control procedures that have helped the organization to better adopt and utilize cutting-edge power transmission technologies.

Agius believes the company will continue this approach in the future.

“We need to consistently update our quality requirements so we can keep meeting our customers’ needs as their businesses are ever changing. AS9100D is a quality framework that gives us the tools to keep building out our quality systems and standards, however necessary, well into the future.

Nordex.com

STLE

ANNOUNCES KEN HOPE AS 2021–2022 PRESIDENT

The Society of Tribologists and Lubrication Engineers (STLE)—the technical society serving individuals, companies and organizations that comprise the tribology and lubrication engineering business sector—recently announced that **Ken Hope**, Ph.D., global PAO technical services manager, for Chevron Phillips Chemical in The Woodlands, Texas, will assume the role of 2021–2022 president for a one-year term beginning May 18.



In his new role, Hope will serve as the principal executive officer of the society and as chairman of its board of directors. Hope served on the STLE Board of Directors from 2006 to 2017 and in 2018 became a member of STLE's Executive Committee, serving one-year terms as treasurer, secretary and vice president.

Joining him on the STLE Executive Committee are Vice President Ryan Evans, Ph.D. (The Timken Company), Secretary Hong Liang, Ph.D. (Texas A&M University), Treasurer Jack McKenna, (Sea-Land Chemical Company), Immediate Past President Paul Hetherington (Petro-Canada Lubricants Inc.) and STLE Executive Director Edward P. Salek.

www.stle.org

Manus Award

HONORS CREATIVE USE OF PLAIN BEARINGS

For the first time, the manus award, a joint initiative by Igus, a motion plastics specialist, recognizes four contestants. The prize showcases fascinating, creative uses of plain bearings. The tenth gold manus award goes to Kässbohrer Geländefahrzeug AG for its PowerBully. Silver goes to a radio-controlled, battery-driven felling wedge. Bronze goes to a sun protection facade system with a shape memory alloy. The first-ever green manus was awarded for a sustainable project. It went to an intelligent solar-powered rubbish bin from Finland.

Gold for a German carrier vehicle

The gold manus award and 5,000 euros prize money went to Kässbohrer Geländefahrzeug AG for its PowerBully. The PowerBully is an all-terrain carrier vehicle with large payloads for a variety of applications. It is used wherever roller-driven vehicles cannot go. Given the appropriate superstructures, the PowerBully can, for instance, be used to lay power and telephone lines, fight fires, analyse soil, or perform mulching work. All of its components must be extremely robust and able to handle great forces, as must the plain bearings used in the floating axle and the tensioning axle. The design engineers consulted igus and chose wound XXL iglidur TX1 plain bearings. They are lubrication-free and insensitive to dust and dirt. This is an extreme-conditions application, which also convinced the judges.

Silver for a radio-controlled, battery-driven felling wedge

The silver manus went to Forstreich GmbH, a German company. The last few dry years have made it increasingly dangerous to fell trees with a hammer and wedge. So, Stefan Reichenbach has developed a radio-controlled, battery-driven felling wedge. The forester places the wedge in the saw cut and starts the felling process, maintaining a safety distance. The design engineers used drylin W double rails with polymer pillow blocks for the felling wedge's linear movements. They also used iglidur G plain bearings. The components allow the wedge to absorb radial forces over a long service life—even in environments with dirt, sand and wood chips.

Bronze for a sun protection facade system

Third place went to the French company Arcora for a sun protection facade system with a shape memory alloy. When the alloy heats up, the system can set a translational carriage in motion. This carriage transfers the force to the rotating sun protection fins via small connecting rods. This allows standard motorisations in building facades to be replaced. At the interfaces between moving and fixed elements, the design engineers used Igus high-performance polymers, including igubal spherical bearings, iglidur J polymer fixed flange bearings and drylin N miniature guide rails.



Sustainability prize for an intelligent rubbish bin

This year saw the first green manus, which is awarded for using polymer plain bearings in especially sustainable projects. The award went to Finbin, a Finnish company, for developing an intelligent, solar-powered rubbish bin. The patented technology in the waste system ensures that the waste is compressed at a ratio of 6:1. The rubbish bin autonomously notifies the waste management system of its fill level. It is of primary importance that all bin components be long-lasting and maintenance-free. That is why plain bearings made of the iglidur G tribo-polymer are used in the clamping rods for the hatch, pedal and pedal transmission rods. The bearings work without external lubricants and are insensitive to dust and dirt.

www.igus.eu/manus

CALL FOR PAPERS!

Are you sitting on an idea for a technical paper but wondering where to present it? Do you have one already written, sitting on your desk, gathering machine dust?

How about *Power Transmission Engineering*? We are always looking for gearing- and power transmission component-relevant technical papers for publication in the magazine and in its digital version. Having your work appear in *Power Transmission Engineering* guarantees you an audience of the most experienced and discriminating industry players. You say your work has not been peer-reviewed? Not a problem, as we are lucky—and thankful—to have on-hand some of the most experienced and brilliant minds in the industry—our technical editors. So if your work “passes muster” and is published, you’ll know you were reviewed by the best—and most demanding.

Chances are you’ll be creating the paper under the auspices of the company for whom you work or own, or for one of the various industry-relevant associations. That means they as well will bask in the reflected glory that accrues with publication in *Power Transmission Engineering*.

For publication guidelines and more information, please contact Jack McGuinn at jmcguinn@powertransmission.com.

ABB

Page 3
baldor.abb.com

AGMA

Pages 38–39, 43
MotionPowerExpo.com

Andantex

Page 26
andantex.com

B&R Machine and Gear

Page 41
www.brgear.com

BDH Belts

Page 42
www.bdhbelts.com

Beyta Gear Service

Page 35
www.beytagear.com

Bonfiglioli USA

Page 14
www.bonfiglioli.com/usa/en/Bonfiglioli-ecommerce

Brother Gearmotors

Inside Front Cover
BrotherGearmotors.com

Circle Gear

Page 10
www.circlegear.com

Designatronics

Page 7
www.sdp-si.com

Diequa Corp.

Pages 18, 42
www.diequa.com

Force Control industries

Page 16
www.forcecontrol.com

ITW Heartland

Page 29
spiroidgearing.com

JIE USA

Page 40
www.jie-drives.com

Lafert North America

Page 24
www.lafertna.com

Lubriplate

Page 15
www.lubriplate.com

McInnes Rolled Rings

Page 17
www.mcinnesrolledrings.com

NES Bearing Co., Inc.

Page 19
www.nesbearings.com

Neugart USA

Page 2
www.neugart.com/en-us

Nordex Inc.

Page 41
www.nordex.com

PBC Linear

Outside Back Cover
pblinear.com

Philadelphia Gear

Page 9
PhilaGear.com/MyMission

Quicksilver Controls

Page 2
www.QuickSilverControls.com

RBI Bearing

Page 5
www.rbibearing.com

Regal Beloit

Page 13
Regalbeloit.com/USRB-Klamploc

SDP/SI

Page 7
www.sdp-si.com

SEW-Eurodrive

Inside Back Cover
www.seweurodrive.com

SIPCO i.Mak

Page 42
www.sipco-imak.com

SMT

Page 11
smartmt.com/masta

U.S. Tsubaki Power Transmission

Page 31
ustsubaki.com

Worldwide Electric

Pages 23, 37
worldwideelectric.net

Zero-Max

Page 21
www.zero-max.com

Power Transmission Engineering®

FREE SUBSCRIPTION

20PTEALL

Please Respond

Your response ensures that we deliver the magazine only to those who want it. It also gives us the vital information we need to serve you best.

- YES** I want to receive/continue to receive **Power Transmission Engineering**
- NO** Thanks anyway, but I don't need the world's best publication on mechanical components.

Name _____ Job Title _____
(please print)

Signature _____ Date _____
(required)

How would you like to receive Power Transmission Engineering?

- PRINT Version (Verify mailing info below)
- DIGITAL Version (E-mail required)
- BOTH Print AND Digital (E-mail required)

E-mail _____ *

***You can OPT OUT of your e-mail subscription at any time.**

How is THIS LOCATION involved with power transmission products? (Check all that apply)

- WE MAKE power transmission products
- WE BUY power transmission products
- WE SELL power transmission products (Distributors, sales reps, etc.)
- WE DESIGN products with power transmission components in them
- Other (please describe) _____

What is your company's principal product or service? _____

MAILING INFORMATION

NAME:

JOB TITLE:

COMPANY:

ADDRESS:

- Check if this is a home address

CITY:

STATE/Province:

ZIP/Postal Code:

PHONE:

FAX:

If your label is incorrect or incomplete, please update it above!

FAX to 1-847-437-6618

SCAN to: subscribe@powertransmission.com

History-Making Micromotors on Mars!

Helicopter Makes Maiden Voyage Across the Red Planet with Help from Maxon

Edited by Matthew Jaster, Senior Editor

Space fans are thrilled: NASA's Ingenuity helicopter has successfully completed its pioneering flight on Mars. This is the first time in the history of powered, unmanned spaceflight that a device has flown in a controlled manner on another planet.

A short flight for "Ingenuity," but a big success for unmanned space flight. NASA's Mars helicopter flew over the surface of the Red Planet for about 40 seconds on Monday, April 19th and landed back on four legs. From NASA's perspective, this is a historic event similar to the Wright brothers' first controlled flight in 1903.

With the Mars helicopter, the concept of powered, unmanned, and autonomous flights on foreign planets is being tested. This is comparable to the first Mars rover "Sojourner," which paved the way for scientific follow-up missions such as "Curiosity" and currently "Perseverance." "Ingenuity" is about to complete several flights over a period of 30 days, each lasting up to 90 seconds and reaching a maximum altitude of five meters.

Six micromotors control the helicopter's flight direction

The flight is also a great success for Maxon. The helicopter is equipped with six brushed DC motors, which have been specifically modified for this challenge. The DCX series of drives, with diameters of 10 millimeters, control the pitch of the rotor blades and the direction of flight for the helicopter, which weighs only 1.8 kilograms and is solar-powered. The lightweight design is a prerequisite for a successful flight on

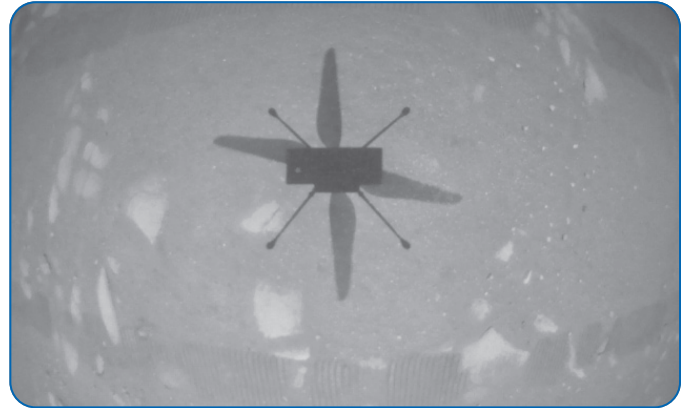

the Red Planet, where there is hardly any atmosphere, comparable to conditions at an altitude of 30 kilometers on Earth.

"The biggest challenge in developing the motors was the extreme weight requirement," says Aiko Stenzel, design engineer at Maxon. "Every tenth of a gram had to be saved to make the helicopter fly. What's great is that despite the weight savings, we found a drive solution that has enough power to adjust the rotor blades. And this in the face of high vibrations and temperature fluctuations." The standard variants of the DCX motors are available for everyone and can be configured online according to the individual customer specifications: shop.maxongroup.us

Eugen Elmiger, CEO of the Maxon Group, watched the NASA transmission of the first flight data live and is thrilled: "It is a fantastic feeling to know that our precision drives worked as planned and that we were able to make our contribution to this historic event. I am proud of our employees and look forward to the next milestones on Mars."

Maxon's drives are also used in the Perseverance rover. There are ten BLDC motors and a special gearbox that will be used, among other things, to handle the soil samples inside the rover.

Just like the more than 100 existing Maxon drives that have been reliably performing their duties on Mars, the motors for Perseverance are based on standard catalog products: specifically, nine brushless DC motors, the EC 32 flat and one of the EC 20 flat motors combined with a GP 22 UP planetary gearhead.

The engineers at Maxon closely collaborated with the specialists at JPL for several years to modify and extensively test the drives. The robotic arm on which the BLDC motors are mounted as well as the gripper are critical to the application and the success of the mission. **PTE**

Learn more here: mars.maxonworld.com

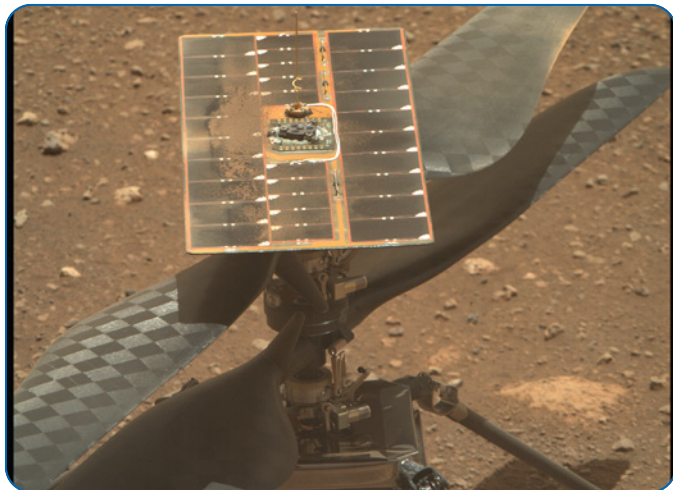



Big...just got **BIGGER-ER**

You've used our gearmotors for decades. You know our quality and count on our world-wide service to keep your systems moving. Well, SEW-EURODRIVE just got bigger-er and better-er! You can now rely on us to support your industrial gearing needs too.

From timber and steel to aggregate and mining, our offerings support torque capacities to over 4,000,000 lb-in. and are relied upon in some of the world's most demanding

environments. The best part... they are available locally with engineering and assembly in South Carolina.

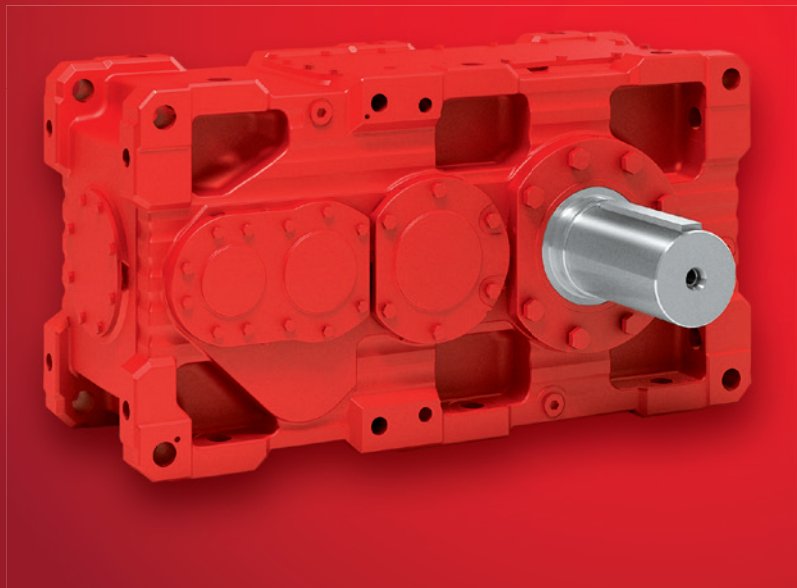

SEW
EURODRIVE

— Driving the World —

Robust Precision & Simplified Assembly You Can Rely On

Hevi-Rail®

The Apex Weightlifter
in Linear Motion

- Heavy Load Capacity
- Combined Radial & Axial Design
- Range of Sizes
- Optional Axial Bearing
Eccentric Adjustment
- Simplified Assembly Makes
for Lower Installation Costs



HVB-063

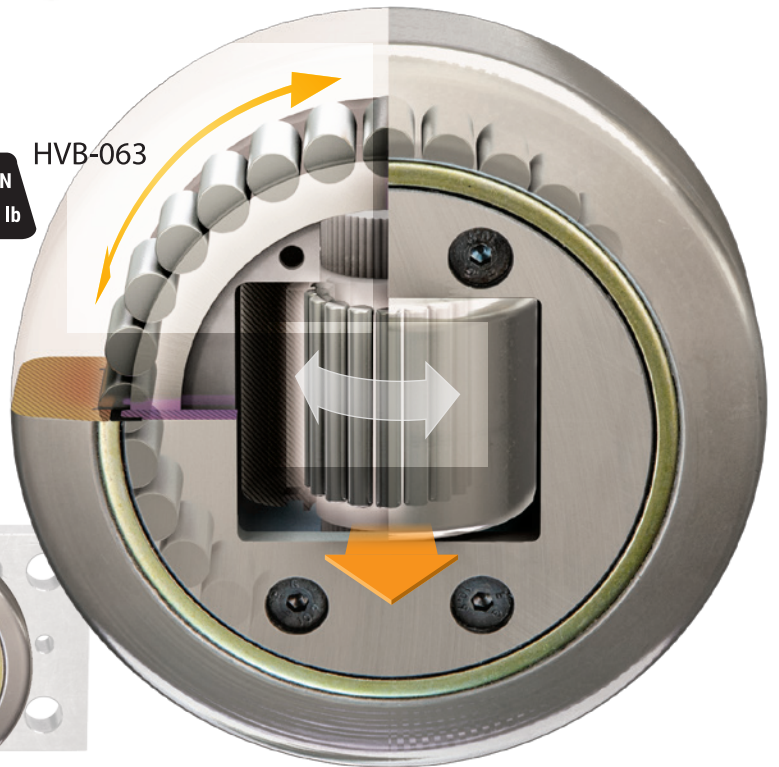

HVB-053



Request a **FREE**
product sample at:

bit.ly/hevirailPTE2021



6402 E. Rockton Road, Roscoe, Illinois 61073 USA • +1.800.962.8979 • pbclinear.com