

Power Transmission Engineering®



JUNE 2019

MOTORS

RIGOROUS REQUIREMENTS HIGHLIGHT
CUSTOMER DEMANDS

MOTORS FOR AEROSPACE

BELTS & CHAIN DRIVES

MATURE CONCEPT, CUTTING EDGE TECHNOLOGY



**PROTECT YOUR PRODUCTIVITY
WITH THE INDUSTRY'S BEST
GEARMOTOR WARRANTY.**

Brother Gearmotor delivers the ultimate peace of mind by introducing our quality 5 year limited warranty on our full line of standard products.

Call us today for a sample gearmotor to try out.

brother
at your side

866.523.6283
BrotherGearmotors.com

Power Transmission Engineering®

JUNE 2019



FEATURE ARTICLES

- [22] **Motor Technology Makeover**
Efficiency, size, space and mounting requirements highlight customer requests for no compromise.
- [30] **Motor Design for Aerospace Applications**
Motors for aerospace applications differ significantly in some areas.
- [34] **Chain & Sprocket Systems and Maintenance**
A mature form of power transmission, there are still many industrial applications for which drive chain is suited.
- [40] **Advanced Belt Drive Systems**
Enhancing safety, quality, delivery and cost.

TECHNICAL ARTICLES

- [44] **Documentation of Gearbox Reliability — an Upcoming Demand**
A method is presented for transferring safety factor of each component into failure probability based on a Weibull distribution — taking material properties into account.
- [50] **Pros and Cons of Different Bearing Lubrication Methods**
From manual grease guns to automated systems, bearing lubrication requires consideration of cost, ease-of-use, safety, accuracy and other factors.

Vol. 13, No. 3. POWER TRANSMISSION ENGINEERING (ISSN 2331-2483) is published monthly except in January, May, July and November by Randall Publications LLC, 1840 Jarvis Ave., Elk Grove Village, IL 60007, (847) 437-6604. Cover price \$7.00. U.S. Periodicals Postage Paid at Elk Grove Village IL and at additional mailing offices. Send address changes to POWER TRANSMISSION ENGINEERING, 1840 Jarvis Ave., Elk Grove Village, IL 60007.

Randall Publications LLC makes every effort to ensure that the processes described in POWER TRANSMISSION ENGINEERING conform to sound engineering practice. Neither the authors nor the publisher can be held responsible for injuries sustained while following the procedures described. Postmaster: Send address changes to POWER TRANSMISSION ENGINEERING, 1840 Jarvis Avenue, Elk Grove Village, IL, 60007. ©2019 Contents copyrighted by RANDALL PUBLICATIONS, LLC. No part of this publication may be reproduced or transmitted in any form or by any means, electronic or mechanical, including photocopying, recording, or by any information storage and retrieval system, without permission in writing from the publisher. Contents of ads are subject to Publisher's approval.

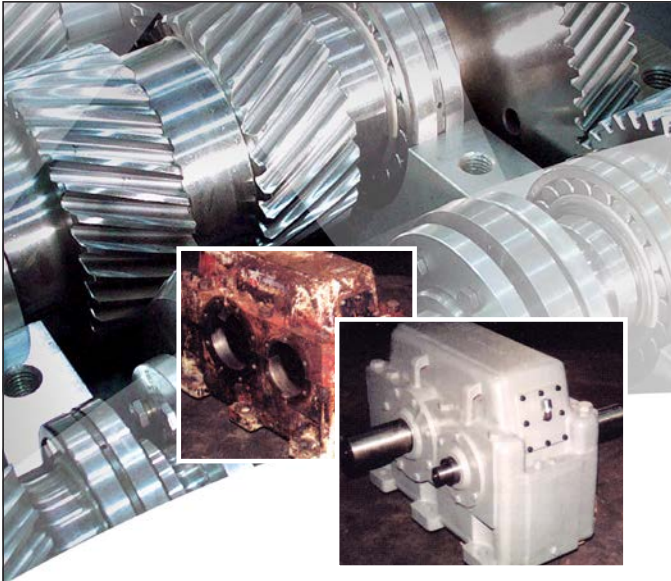

Let Nuttall Gear / Delroyd Worm Gear
be your partner for

Gear Box Rebuilds & Repairs

Our extensive experience in gear drive applications, combined with the total manufacturing and design capabilities enables us to provide you with a single, comprehensive source for improving your productivity, and offers you a cost-effective repair solution for **any manufacturer's gear drive**.

- REPAIR AND REBUILD
- REDESIGN AND RERATE
- SYSTEM ANALYSIS
- QUALITY ASSURANCE
- LOAD TESTING
- FIELD SERVICE
 - 24-hour Emergency Service
 - Mill Outage Support Services
 - Predictive Maintenance Services
 - Repairs
 - Torque Measurements
 - Training Seminars

All Complete Rebuilds Include New Factory Warranty

 **Nuttall Gear**[®]
Altra Industrial Motion

 **Delroyd Worm Gear**[®]
Altra Industrial Motion

Contact Us:

2221 Niagara Falls Blvd., Niagara Falls, NY 14304-5710 – USA
info@nuttallgear.com | info@delroyd.com
1-716-298-4100

www.nuttallgear.com/services/rebuild-services
www.delroyd.com/services/rebuild-services

Power Transmission Engineering

VOL. 13, NO. 3

- [04] **PTEExtras**
The Electric Evolution; Smart Gearboxes.
- [06] **Publisher's Page**
Get Ready, Get Set... SHOW!
- [08] **Product News**
SKF celebrates 100 years of the spherical roller bearing; **Bison Gear** launches next-generation permanent magnet AC motor; **Siemens** expands Simogear motor range.
- [38] **Engineering sMART**
Products and services marketplace.
- [54] **Industry News**
AGMA Announces Additive Manufacturing Publication for Gear Making; **Nord Gear** Celebrates 40th Anniversary in the United States with 6th Expansion.
- [61] **Calendar**
June 23–26: Powdermet 2019, Sheraton Grand, Phoenix, Arizona;
July 23–24: 8th WZL Gear Conference USA, Westminster, Colorado.
August 20–22: AGMA Detailed Gear Design, Clearwater Beach, Florida.
- [62] **Advertiser Index**
Contact information for every advertiser in this issue.
- [64] **Power Play**
Cars with Jet Engines.



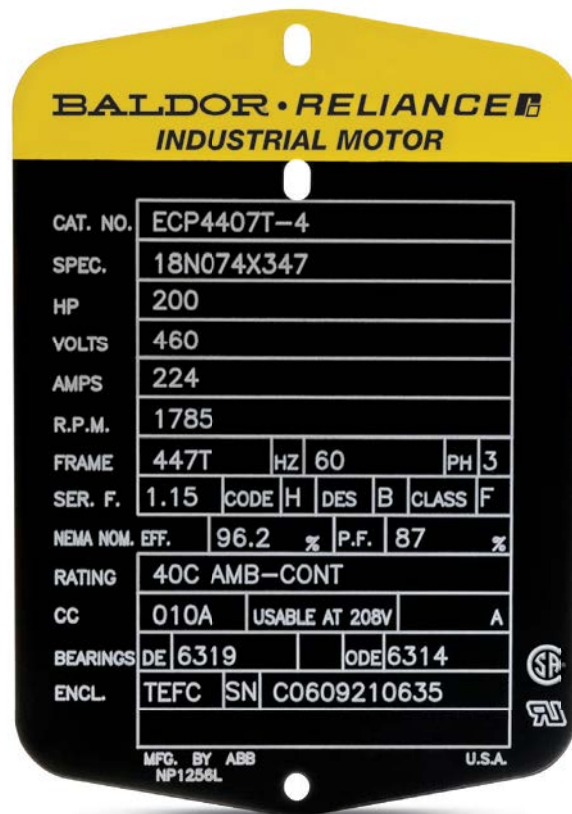

The sign of reliability

For more than 100 years, ABB has developed a reputation for marketing, designing and manufacturing the most reliable industrial electric motors available. Azima, Inc. confirmed this in their Reliability Rating Report in which they stated that “ABB produces the majority of models scoring highest for reliability in 2018.”

When reliability counts, look for the [sign of reliability](#) from ABB.

INDUSTRY LEADING

DRIVE SYSTEMS & SUPPORT

CUSTOMER BENEFITS

- Industry's shortest lead times
- Expert Customer Support
- 24/7 Breakdown Support
- Online Customer Support Tools



**DISCOVER
SELF-SERVICE NOW!**
BENEFITS.MYNORD.COM
888-314-6673



www.powertransmission.com

Editor's Choice The Electric Evolution

The challenges remain the same regarding the electrification of the automotive industry. A majority of the discussions during the recent CTI Symposium USA in Novi, Michigan focused on areas like battery life, battery range, cost issues, buyer needs, buyer incentives and charging stations. Learn more about this event here: www.powertransmission.com/blog/the-electric-evolution/.



Smart Gearboxes



Digital transformation is a catalyst for profound changes in all branches of industry. Products, production, sales and work culture are all going digital in the Industrial Internet of Things (IIoT), creating huge opportunities in the process. Wittenstein SE recognized this trend early on and has already been pursuing a digitalization strategy for several years now — with considerable success. Learn more here:

www.powertransmission.com/blog/smart-gearboxes/.

ABMA Training Event — Essential Concepts of Bearing Technology

Oak Brook, Illinois. This course will give attendees an overview of the bearing industry as well as basic bearing types and applications. Knowledge of the key players, bearing types and terminology will ensure that everyone has a basic knowledge of the industry upon arrival. Learn more here: www.powertransmission.com/news/8820/ABMA-Essential-Concepts-of-Bearing-Technology/.



Stay Connected



Follow us on Twitter
twitter.com/#!/PowerTransMag



Connect with us on LinkedIn
www.linkedin.com/groups/Power-Transmission-Engineering-PTE-2950055



Subscribe Online
www.powertransmission.com/subscribe.htm



PREMIUM QUALITY WITHOUT THE PREMIUM PRICE

Introducing the AXPB RBtech line of precision bearings for heavy duty applications... world-class quality, cost effective solutions.

- Spherical Roller Bearings
- Cylindrical Roller Bearings
- Tapered Roller Bearings
- Angular Contact Ball Bearings
- Sheave Bearings
- Gear/Bearing Assemblies

Discover the AXPB RBtech difference.



For 30 years, RBI has focused on providing quality bearings, castings, precision machined parts and assembly solutions at a reasonable cost.

1-800-708-2128
www.rbibearing.com

Keeping the world In motion >>

Get Ready, Get Set... SHOW!

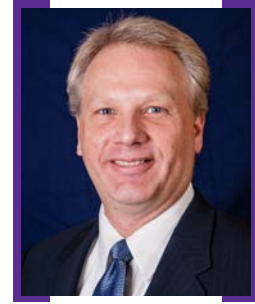

If you are involved in the acquisition of technology (whether your direct role is machine design, maintenance, purchasing or management), trade shows still provide one of the best ways to evaluate options, learn about the latest technology and find solutions to problems.

For example, the upcoming Motion+Power Technology Expo (motionpowerexpo.com) takes place in Detroit, from October 15–17. The show, formerly known as Gear Expo, is organized by the American Gear Manufacturers Association. As you can guess from the new name, the show is about far more than gears. In fact, the association is working hard to make Motion+Power Technology Expo into an event that represents the whole supply chain for mechanical power transmission.

So, as in the past, you can expect to find gear, gear drive and transmission manufacturers displaying their solutions for everything from custom gears to complete gearbox solutions for virtually any applications. As of this writing, more than 50 gear and gear drive manufacturers will be exhibiting. But if you're interested in manufacturing your own gears, you'll also be able to find every major manufacturer of equipment for gear cutting, grinding, inspection, workholding and much more.

In addition, part of the growth of the show is in the areas of fluid power and electric power. Motion+Power Technology Expo includes a fluid power pavilion, co-organized with AGMA by the National Fluid Power Association.

Power Transmission Engineering will be exhibiting at Motion+Power Technology Expo (booth #3826), along with our sister publication, *Gear Technology*. In our booth, we'll be recording the third season of our popular "Ask the Expert Live!" show. You can participate in "Ask the Expert Live" by bringing your toughest design, maintenance or application challenges. We'll have experts lined up to answer your questions live.

Just like the AGMA has done, we'll be increasing the scope of "Ask the Expert Live" to topics beyond gears. Over the coming months, we'll be announcing our topics and panels of experts, so stay tuned for more information. Also, if you'd like to see previous seasons of "Ask the Expert Live," just go to www.powertransmission.com/tv.

In addition to "Ask the Expert Live," we'll also be conducting live interviews with various experts from exhibiting companies. You can be sure that when you come by our booth, you'll be likely to hear from the most knowledgeable experts talking about the latest technology and its application.

You might be wondering why I'm putting so much emphasis now on a show that doesn't take place until the middle of October. The reason is simple. You need to make plans.

You should book a room and arrange for travel. That's obvious. But in order to make the most of this event, you need to do a little homework, too. Figure out which exhibitors you need to see and make appointments. Figure out what technical problems you need to find solutions for.

I don't have the space here to describe all of the benefits of attending. I haven't even mentioned all of the educational opportunities taking place in addition to the exhibits. There will be presentations at the show's "Solutions Center" throughout the expo. There are also concurrent educational sessions, including a new MPT Conference with future-oriented topics like blockchain, cybersecurity, 3-D Printing, IIoT and more. Of course, there's also the AGMA Fall Technical Meeting, which takes place October 14–16.

Sure, you can just show up, and you'll still get a lot out of it. But if you come to the show with a plan, you'll maximize the value of your time spent there. All the information you need is at motionpowerexpo.com.

We're making plans for Motion+Power Technology Expo now. We hope you are, too.

A handwritten signature in black ink that reads "Randy Stott". The signature is written in a cursive, flowing style.

THE COUPLING.

**FOR MAINTENANCE-FREE
DURABILITY**



LP

DISC PACK COUPLINGS

RW-AMERICA.COM

R+W[®]
A POPPE + POTTHOFF COMPANY

SKF

CELEBRATES 100 YEARS OF THE SPHERICAL ROLLER BEARING

Originally developed in 1919 by an SKF engineer, Arvid Palmgren, the spherical roller bearing (SRB) has since made its mark worldwide.

Created to complement the self-aligning ball bearing, due to its ability to accommodate misalignment under heavy loads, the initial SKF design has now become part of the largest family of products in the industry.



On the fabled Las Vegas Strip in the United States, the High Roller ferris wheel contains two of the largest SRBs ever produced by SKF, each weighing in at 8.8 metric tons. SKF spherical roller bearings can be found in many applications, including some where you might not expect them. A good example is the Bahrain World Trade Center, where three tower wind turbines, each 29 meters in diameter, are architecturally installed between the two 240-meter-high (50-story) towers and generate 1,300 MWh per year. The main shafts of the turbines were equipped with SKF spherical

roller bearings. The turbines went online in March 2008 and are operational 50 percent of the time, depending on wind conditions. Another alluring application fitted with SRBs is the rebirth of the Zeppelin after 60 years of absence following the Hindenburg disaster. SKF was brought in by ZF, the gearbox manufacturer for the Zeppelin NT, to help the new and improved airships to propel forward.

SKF's extensive SRB range delivers a range of benefits for specific operating conditions. For example, operators in contaminated environments in heavy industrial applications have increased their bearing rating life by up to four times with sealed SKF spherical roller bearings. Those working in the harshest of environments have benefitted from SKF's Three-Barrier Solution that delivers cost-effective, optimized rating life, minimal maintenance spherical roller bearings. New dimension gearbox design has even become possible thanks to SKF Explorer SRB's long service life and high performance.

Petra Öberg Gustafsson, product line manager self-aligning bearings at SKF comments: "From the very start, SKF has taken the lead in the development of self-aligning bearings. We introduced spherical roller bearings in 1919 and have been consistently improving them ever since. Building on Arvid Palmgren's original design, we now offer engineers the widest range of both open and sealed spherical roller bearings in the industry. With the continued push for high performance in ever more challenging environments, it will be interesting to see what the next 100 years of development generates!"

For more information:

SKF USA Inc.
Phone: (800) 440-4753
www.skfusa.com

Bison Gear and Engineering

LAUNCHES NEXT GENERATION PERMANENT MAGNET AC MOTOR

Bison Gear and Engineering recently launched VFsync, a next generation permanent magnet AC motor. Designed for today's demanding machine drive applications, the new synchronous motors run at high efficiency with advanced variable frequency drives. The IP66/IP54 platform of three phase motors range in power from .25 to 1.5 hp, and are supplied with swivel connectors and shielded cables to make installation trouble free. Popular frame sizes include IEC B14, sizes 71, 80 and 90 along with NEMA 56C mounting. The product line includes the new motors, quick connect cables and a market leading, programmable and networked VFD available in an IP 20 panel style or enclosed IP66 models.

The new motors were optimized with FEA software and then tooled with highly efficient internal permanent magnet style rotors. VFsync provides a compact footprint that is 56% smaller and 63% lighter than common 3-phase induction motors. VFsync motors were designed to work seamlessly with



Bison Gear and Engineering's line of integral horsepower gear reducers to power even the most demanding applications with precise speed control. Each frame size is available in either 230 or 460 V construction, and either TENV, TENV w/encoder or TEFC styles.

For more information:

Bison Gear & Engineering Corp.
Phone: (800) 282-4766
www.bisongear.com



PRECISE. ROBUST. AVAILABLE

These new generation CD® Couplings feature zero backlash precision and high torsional stiffness. They answer today's demanding needs in servo motor applications with high reverse loads and positioning requirements. New clamp style hubs handle increased torque on shafts without using keyways. Manufactured of RoHS compliant materials.

Now size, select and see the right CD® Coupling solution for your coupling application with Zero-Max 3D CAD files.

Check our FAST deliveries.



www.zero-max.com 800.533.1731

////// ZERO-MAX®

Omron

OFFERS AI CONTROLLER TO EXTEND EQUIPMENT LIFE

A new solution for human-machine collaboration is now available from automation solutions provider Omron Automation Americas. The Sysmac AI Controller handles several key steps in the data-driven decision process for predictive maintenance, thereby freeing up industrial professionals from tedious calculations, analyses and infrastructure upgrades.

This powerful solution can help manufacturers reduce the risk of bad parts or equipment damage by detecting issues early on and prompting immediate action to resolve them. Customers will be able to take advantage of Omron's advanced technology and its team of data scientists to facilitate predictive maintenance rather than figuring everything out on their own.

The AI functionality — also known as “machine learning” — is able to identify abnormal machine behavior without being explicitly programmed to do so. Since there could be many different factors and measurements that indicate an issue when observed together,

automating the feature extraction process saves a significant amount of time and resources. Leveraging the machine learning results during production is key to ensuring end user cost savings.

The process of collecting raw data from machines is completely automated by the new AI controller which operates on the “Edge” within the machine, ensuring higher data fidelity and consistency. In addition, the controller automatically creates data models from correlation analysis and monitor machine status based on that model. Without this automation, machine designers and operators would otherwise need to develop their own analytics and optimization capabilities in order to avoid cloud solution costs.

Rather than being a cloud solution, Omron's unique approach to artificial intelligence-based control involves hardware, offline software and in-person service. No internet connectivity



or IT infrastructure/service is required. The hardware is based on the Sysmac NY5 IPC and the NX7 CPU and includes Omron's AI Application Components, a library of AI predictive maintenance function blocks. Several additional AI specific utilities are also included.

Because the data collection and analysis is performed within the same hardware as the controls program, the solution provides the utmost data processing speed, accuracy and security. For the service component, Omron experts will assist in startup and provide periodic support.

For more information:

Omron Electronics LLC
Phone: (847) 843-7900
automation.omron.com/en/us/

Miki Pulley

ELECTROMAGNETIC BRAKES PROVIDE MORE STOPPING POWER TO SERVO MOTORS

Miki Pulley spring-applied electromagnetic brakes safely hold a static position, without the need for external power. The BXR-LE Miki Pulley brake series is a power-off, engaged brake design. When the stator is energized, the brake is disengaged allowing free rotation. When no current is applied, compression springs halt the brake

rotor thereby stopping the input shaft rotation. This is an ideal feature to prevent rotation during power failure events.

Now there are 6 total size configurations in the BXR-LE series to choose from, all of which are designed for smaller machine and robotic applications, where cantilevered loads can

negatively impact operation.

These brakes have a slim design and high holding torque in a very compact package. They provide quiet operation with long service life. The brake's unique compact and lightweight design optimizes machine design efficiency. With accompanying voltage controller, power consumption is stepped down to 7 VDC after a split second of 24 VDC for brake actuation.

Typical servo motor applications include: Robotic arm joints to stop movement during a catastrophic power failure, Z-axis ball screw brakes on 3D printers, Pan/tilt brakes for security cameras, brakes for locking sensor alignment and many more.

For more information:

Miki Pulley US
Phone: (800) 533-1731
www.mikipulley-us.com





MOTION+POWER
TECHNOLOGY EXPO

GEAR ELECTRIC FLUID POWER

»»»» MOVING THE FUTURE.

OCTOBER 15–17, 2019 | DETROIT, MICHIGAN | COBO CENTER

At MPT Expo, you'll see the entire power transmission supply chain — with mechanical, fluid power, electric, and hybrid solutions. Sign up for the MPT Conference, a two-track event focusing on business trends and emerging technologies. AGMA's Fall Technical Meeting will be held concurrently with MPT Expo, and education seminars will also be presented by industry experts.

NETWORK WITH MORE THAN 4,000 OF YOUR PEERS IN DETROIT THIS OCTOBER.

REGISTRATION IS NOW OPEN! Visit MotionPowerExpo.com



American
Gear Manufacturers
Association

Sponsoring organization:



Co-located with: **HTS**
ASM INTERNATIONAL



Heidenhain

OFFERS SINGLE-SECTION LINEAR ENCODER FOR ABSOLUTE APPLICATIONS

Long machine tool axes are increasingly being equipped with linear drives, and Heidenhain's new LC 201 absolute linear scale was introduced to specifically meet those drive position feedback needs. This new scale is a single-section METALLUR tape encoder which is ideal for use in linear motor applications that may be required to reach high acceleration levels within the linear drive systems.

Heidenhain's LC 201 scale is especially useful in the machine tool and aerospace machining sectors, but will also work in applications for electronics, automation, medical technology and metrology industries.

The encoder has an absolute 2-track

graduation and a large single-field scanning window - using a reflective light method of scanning. This produces high signal quality, resistance to contamination - all with no homing routine required at start-up. This new single-section encoder is available in measuring lengths from 440 mm to 4240 mm, and the multi-section version goes up to 28 meters or more with the TNC Control. This new encoder uses the same reader head and cables as its multi-section older brother.

Developed as an addition to the LC 200 linear encoder family, the LC 201 has its same form, fit and functionality. Also, the entire LC 2xx series encoders are bolt-hole compatible with

Heidenhain's LB 382 series encoders, thereby providing a simple upgrade path for existing machines from incremental to absolute feedback.

Special features of the LC 2xx series encoders are:

- Absolute feedback in a one-piece scale body.
- Selectable thermal properties.
- Improved end blocks with integrated sealing air throttle.
- Multiple scanning units can be installed on one scale.

For more information:

Heidenhain Corporation
Phone: (847) 519-4856
www.heidenhain.us

H2W Technologies

EXAMINES COIL REDUNDANCY

In the case where an actuator is installed in a location where access is limited or where downtimes may be costly, there is a need for redundancy in a voice coil. A redundant voice coil comes with multiple coils and is designed to operate with equal performance in each of coil/magnet pairs. Each coil operates independently of the other and will have little to no effect on the other coil while in operation.

Other systems require simplified circuitry which would not allow the change of current polarity in order to change the direction, in these cases each coil can be used to drive the coil in a single direction. The challenge in manufacturing a redundant coil is ensuring the same performance no matter the coil, which requires precise manipulation of the magnetic

circuit design, and the precise coil layout to ensure the identical operation and constants for each coil. This will allow the controls to seamlessly switch between the two coils.

There are two ways of accomplishing this coil redundancy. The most common way would be to generate multiple coils operating on individual magnetic circuits. This requires a longer coil and multiple magnetic circuits; however this is the most robust design and the least vulnerable to damage or interference from the redundant coil. The NCC08-18-025-2R2C is an example of the multiple coil design. An alternate method, which allows for the most compact solution, would be a multifilar wind. This method only requires one magnetic circuit, which is why the length is shorter. In this case multiple



coils are wound in the same winding space.

For more information:

H2W Technologies, Inc.
Phone: (888) 702-0540
www.h2wtech.com



THE **SUPERIOR** CHOICE

WEG's proven reliability in a Rolled Steel frame



- Rated Output: .25 to 25 HP
- 3600, 1800, 1200, 900 rpm
- 48-256T frame
- Foot mount, C-Face or footless available
- AEGIS® SGR Inside (up to 20 HP in stock)
- Brake Motors now available

- Robust base and eyebolts
- Superior Cooling System
- Dual Rated 50/60 HZ
- Class F Insulation
- Aluminum Enshields



Wide Range of Configurations in stock.

Transforming energy into solutions.

www.weg.net | 1-800-ASK-4WEG

Haydon Kerk Pittman

ANNOUNCES HKP MOBILE APP

Haydon Kerk Pittman, a business unit of Ametek Advanced Motion Solutions division, recently announced the release of the HKP Mobile App.

The HKP Mobile App offers streamlined user experience that optimizes accessibility and a wide variety of resources: applications suggestions, product data sheets, brochures, catalogs, guides, technical documents, case studies, white papers and more. Each resource can be easily shared among colleagues and teams with the "Send Asset" feature.

Additionally, customers can view our videos without Wi-Fi, locate a sales representative nearest to their location, and contact us for technical support or a quote. The HKP Mobile App also allows customers to shop the Haydon Kerk Pittman online store for hundreds of products that ship for free and in 24 hours.

Install the HKP Mobile App for special access to deals, promotions and push notifications. Receive advance notices of new products, demos, videos, white papers and so much more. The app offers greater convenience and simpler navigation. Don't miss out — download today. For use on Apple and Android mobile devices.

New HKP Mobile App





Apple Store®



Android®



For more information:
 Haydon Kerk Pittman (Ametek, Inc.)
 Phone: (203) 756-7441
www.haydonkerkpittman.com

screw jack lifting systems 🔍

Did you mean: **DieQua Corporation?**



The search is over!

For quality screw jacks that give you all the options in a complete package with the most advanced designs, look no further than DieQua.

- 12 sizes, lifting capacities up to 100 tons
- Precision machine and ball screws
- Standing and rotating versions
- Multiple spindle end connections
- Multiple driving nut designs

To finally find what you're looking for, check us out on the web, or give us a call.

diequa.com/pte **800-804-8619**
DIEQUA
 Corporation



Zero-Max

OVERHUNG LOAD ADAPTORS SIMPLIFY SET-UP AND INSTALLATION

Overhung Load Adaptors from Zero-Max are now available in Double-Male Shaft Models. They simplify set-up and installation, provide protection from external contamination, and provide support for overhung loads both radially and axially.

The Double-Male Shaft OHLA version is a compact, self-contained design that provides a common mounting surface incorporating an input and output shaft. Alignment of both shafts is assured by design. It is a far superior, one-piece solution replacing multiple components often used to make the twin shaft connection.

Additional features include: sealed housing prevents internal contamination from outside operating environment, saves time and cost of installation, rugged cast iron housing design attractively coated, 130,000 psi stress-proof steel shafts, ball, tapered roller or spherical bearings available.

Applications include: (1) Jackshaft designs where the driveline is supported by the OHLA with a small sprocket at one end and a large sprocket

at the other end. (2) Pump and blower setups where an electric motor is coupled to one end of OHLA and an impeller or blower fan is mounted and supported at the other end. (3) Power take-off (PTO) where one OHLA shaft end connects to a female spline input on an engine, gearbox or transmission while the other end provides a male output shaft. (4) Female through-bore setups where the OHLA shaft extends through the unit acting as a supporting pillow block bearing and the sealed OHLA housing prevents contamination from the operating environment.

In addition to Double-Male Shaft OHLAs, Zero-Max provides a wide range of customized OHLAs required for special application requirements. A new 48-page OHLA catalog features a dedicated section describing the full-range of available special features.

For more information:

Zero-Max Inc.
Phone: (800) 533-1731
www.zero-max.com



MASTA

Next generation CAE software for the design, analysis and optimisation of transmission systems



DESIGN



ANALYSE



OPTIMISE

DESIGN GEARBOX AND DRIVELINE SYSTEMS FROM CLEAN SHEET OR IMPORTED CONCEPTS. RUN AND GENERATE REPORTS ON A WIDE VARIETY OF ANALYSES INCLUDING STATIC DEFLECTIONS, DURABILITY, EFFICIENCY, FREQUENCY DOMAIN NVH, TIME DOMAIN DYNAMICS AND MORE

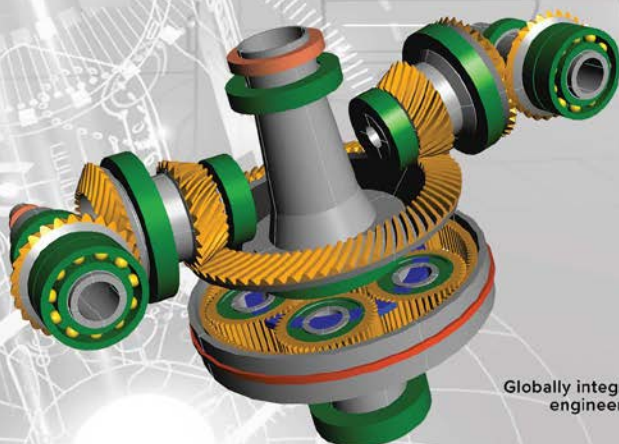

FOR AEROSPACE

MASTA HAS SERVED A RANGE OF AERO RELATED MECHANICAL TRANSMISSION DESIGN PROJECTS INCLUDING THE DESIGN OF ACCESSORY GEARBOXES, PROPELLER REDUCTION GEARBOXES AND AIRCRAFT-MOUNTED ACCESSORY GEARBOXES

Discover more at masta.smartmt.com

Globally integrated leader in mechanical transmission engineering services and software development

© 2019 Smart Manufacturing Technology

SMT

Siemens

EXPANDS SIMOGEAR MOTOR RANGE

Siemens introduces the Sinamics G110M, a motor-integrated drive for Simogear gear motors, offering flexible control, integrated safety, simple installation and a space-saving design. With a high degree of protection—up to IP66—this new gear motor drive provides the perfect solution to most material handling-related challenges, including conveyors, warehousing, logistics, baggage and cargo handling, post and parcel shipping, plus numerous industrial applications in the automotive, appliance and test stand industries.

Simogear gear motors offer high torque density, low noise and high efficiency—and now with Sinamics G110M, it becomes easier for designers and system builders to integrate gear motors into a variety of control architectures. Plug connections for onboard I/O ensure fast installation, while optional power connectors deliver even more time savings. The system is delivered pre-configured and the drive offers simple yet comprehensive onboard diagnostic features. Options such as internal braking resistors and motor brakes—operational simultaneously—and integrated features such as “Quick Stop” and the limit switch function make this system ideal for conveyor applications. For uses requiring safety technology, the Sinamics G110M offers integrated safety functions



such as “Safe Torque Off” (STO), which can be activated via a fail-safe input or via Profisafe, without needing additional safety monitoring components.

Sinamics G110M features integral USS/Modbus RTU, Profibus and Profinet / EtherNet/IP communication profiles.

For more information:

Siemens Industry, Inc.
 Phone: (800) 879-8079
www.youtube.com/watch?v=GgDxptBqPHg



Napoleon Engineering Services



1001
ERING TABLE

ABEC 5
Cronidur 30 per AMS-5898
Rc 58 - 62
16 - 7/16" (.4375)
(2.7559)
.0037-.0041
27.5° Ref.
.0012 Ref.
3%
.017 Max.



Made-to-print
CUSTOM
BEARINGS

- ▶ Unique Materials
- ▶ Shorter Lead Times
- ▶ Small and Large Quantities
- ▶ Application Engineering Support

nesbearings.com • sales@nesbearings.com • (877) 870-3200



TRUSTED IN THE MOST HOSTILE ENVIRONMENTS.

NASA'S \$2.5 BILLION MARS CURIOSITY ROVER



More gears on
Mars than any
other company
in the universe.



Wittenstein Smart Gearboxes

SHAPING THE FUTURE OF MANUFACTURING
CONTRIBUTED BY WITTENSTEIN

Digital transformation is a catalyst for profound changes in all branches of industry. Products, production, sales and work culture are all going digital in the Industrial Internet of Things (IIoT), creating huge opportunities in the process. Wittenstein SE recognized this trend early on and has already been pursuing a digitalization strategy for several years now — with considerable success.

Patrick Hantschel is in charge of the Digitalization Center at Wittenstein, where 30 or so sensor, electronics, software, data and cloud specialists are actively shaping the digital transformation and driving it forward Group-wide.

“There’s no doubt that digitalization’s greatest potential lies in the increased efficiency and added value of our own products as well as in the development of smart products, additional services and derived business models,” said Hantschel.

This is reflected in the company’s experience since 2012 with “Future Urban Production,” the shop window factory at the Group’s Fellbach facility.

“That’s where Industry 4.0 concepts have been implemented, tested, optimized and successively integrated into production and logistics,”



The new smart gearboxes with cynapse from Wittenstein alpha are a significant milestone on the company’s path into the digital future.

Hantschel explained.

“It’s accelerated the build-up broad digitalization expertise in manufacturing, assembly, logistics and materials management processes for the entire Wittenstein Group.”

Gearboxes Learning to Talk

Mechatronic drive systems that can collect and communicate information independently are fundamental to the IIoT’s implementation. Their decentralized intelligence enables data that was previously hidden from sight to be mined, so that new knowledge can be created and information flows made more efficient.

“Our drive solutions are increasingly smart as a result, and we’re expanding them with suitable digital services for the Internet of Things and the cloud. This gives Wittenstein the ability to analyze and interpret data. The knowledge gained from data analyses can then be incorporated into data based services and shared with customers,” Hantschel said.

The development of a smart gearbox, which was recently unveiled during Hannover Messe 2019, is one example.

“Gearboxes have always been unable to talk in the past, but now they literally have something to say,” commented Michael Herkert, product management, at Wittenstein alpha.

The Wittenstein product catalog has been gradually going digital for some time now with offerings like the sensorized Galaxie drive system, the iTAS servo drive system with a web server for automated guided vehicles and the smart drive system for heavy-duty torque multipliers.

Herkert said that the new smart gearboxes with cynapse from Wittenstein alpha are a significant milestone on the company’s path into the digital future — thanks to an integrated sensor module that enables Industry 4.0 connectivity.

“In fact, after unveiling the smart gearboxes during Hannover Messe, Wittenstein became the first component manufacturer in our field to bring smart gearboxes to market as standard products,” Herkert said. “They come



The digital transformation represents a major technological and social challenge. At the same time, it opens up new prospects for the future.



INDUSTRY READY

GEAR REDUCER PRODUCTS

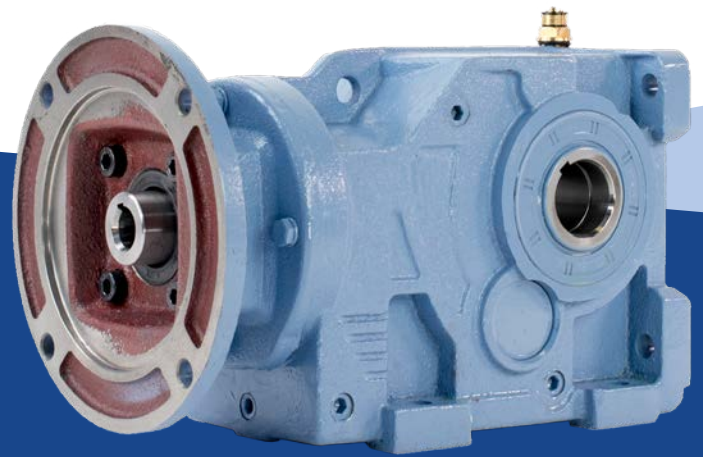

WINL Series Helical Inline Reducers

- Designed for use with standard NEMA C-face motors
- Box sizes 37-107
- Ratios from 2:1-120:1
- Power ranges from 1/4-100 HP

KHN Series Helical Bevel Speed Reducers

- Foot-mounted, NEMA quill input, Right angle, Hollow bore output
- Ratios from 5:1-120:1
- Power ranges from 1/4-30 HP

The WorldWide Electric "WINL" Series and "KHN" Series Speed Reducers deliver a broad range of power and output torque to support a wide range of applications including conveyors, material handling, packaging machines, pumps, fans and textile machinery.

Replaces all major manufacturers at a fraction of the cost from stock!

Quality. Value. Service. We are WorldWide.

1 (800) 808-2131 | worldwideelectric.net | customerservice@worldwideelectric.net



in an industrial grade design, in other words there are no externally mounted parts — with its IO-Link interface and form-closed connection, the sensor module is elegantly integrated into the gearbox.”

It’s a fact that there are no major, external constructional differences between the Premium Line gearboxes with cynapse — they are identical in terms of design, size and contour, so that existing drive solutions need no further modification.

“The most important differentiator is the sensor module, which lets us output data using IO-Link as a standardized interface,” Herkert said.

In practice, this means that smart gearboxes are able to identify and measure influencing quantities in the process and the environment which impact on gearbox operation, and exchange them with the machine control as well as with applications on IIoT platforms.

The cynapse line comes hand in hand with integrated logic functions that are capable of “thinking” and allow gearboxes to execute intelligent monitoring activities independently. Smart gearboxes measure temperatures and report overheating, they detect vibration, they count operating hours, and they store and document all events linked to gearbox use.

“All of this supports condition monitoring and preventative maintenance, minimizes the risk of gearbox damage

or machine downtime, and optimizes the availability and productivity of machines,” Herkert added.

Double ROI

For the first time in this form, gearboxes with cynapse deliver process data that originates directly from the gearbox itself. According to reports from the first lead customers, this direct and transparent visibility enables even more performance, reliability and availability, especially with critical axes. Critical operating states are avoided, laying the ground for efficient process improvements — an invaluable return on intelligence for machine operators.

“Invaluable but not priceless,” Herkert said. “At the very latest, the costs which result from damage far outweigh the comparatively modest markup for the integrated sensor module. When you look at it that way, the return on investment is right as well.”

It comes as no surprise to learn that Wittenstein alpha intends to follow up the launch of its Premium Line gearboxes with cynapse by gradually extending this feature to all other gearbox series.

(This information first appeared in recent issues of Wittenstein’s Move magazine.)

For more information:

Wittenstein North America
Phone: (888) 534-1222
www.wittenstein-us.com



Igus

OFFERS NEW E4Q ENERGY CHAIN

Igus has introduced its new E4Q energy chain, which can be opened and closed in seconds without tools and has been specifically developed for the special requirements of unsupported lengths and long travels.

Igus, the Germany-based manufacturer of motion plastics, unveiled a prototype of the new E4Q in April at Hannover Messe. The chain links have a smooth, contoured design and a completely new crossbar concept with locking straps for weight reduction.

The company runs its North American operations out of Providence, R.I. More information about the new energy chain is available on the Igus website below.

High unsupported lengths and long travels with large fill weight create extreme stress on energy chains. The Igus developers have designed the E4Q e-chain intended for such application scenarios.

Based on the robust energy chain standard E4.1 from Igus, the new series brings along a long service life and a high degree of modularity. In order to optimize material and therefore the weight of the energy chain, shapes inspired by nature are used. The

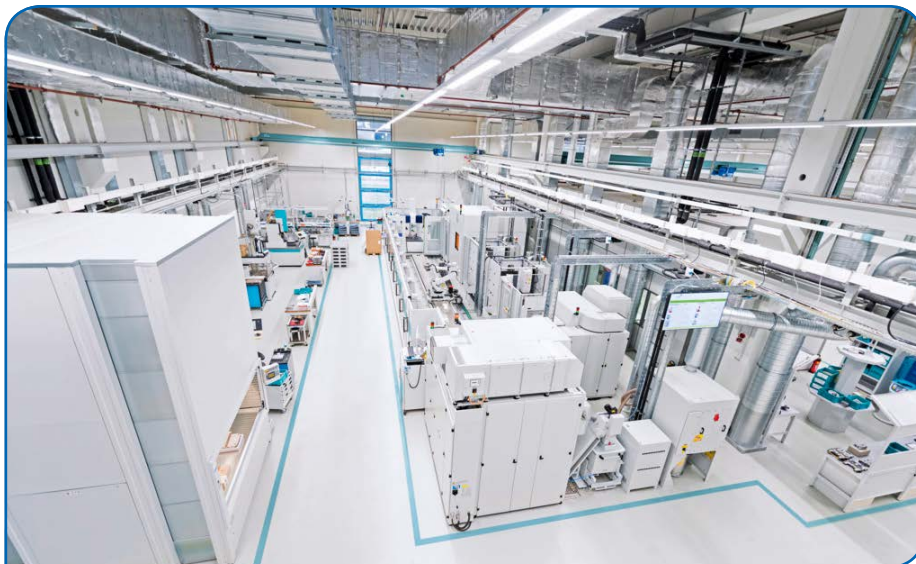

The lessons learned from the Smart Factory are now paving the way for a new generation of Wittenstein products.



and soft material that further reduces the sound level without restricting the stability of the stop-dogs.

For more information:

Igus, Inc.
Phone: (800) 521-2747
www.igus.com

smooth, contoured design can be found on the outside of the chain links as well as on the stop-dogs. Despite material recesses, the new development has high strength and stability comparable to the E4.1 series.

A special feature of the E4Q is the crossbars. These can be opened and closed completely without tools. On the top of the crossbar, there are two hollows for the fingers, by which the locking hooks can be easily pulled up. Unlocked on both sides, the crossbar can be removed with little effort. This allows the easy opening and closing of the chain even in a guide trough and accelerates the filling of the e-chain by up to 40 percent. Another advantage is the new crossbar has significantly higher pull-out forces than its counterparts in the locked state thanks to its innovative type.

Due to the special design of the e-chain, it is very quiet in movement. However, if the user desires additional noise reduction, Igus has integrated an optional system in the inner horizontal stop-dog for the E4Q. A dampening element is used to cushion the impact between links in operation. The element is made of a new noise-optimized



WE EXCEL at high speed, high accuracy generating grinding for all applications:

- Gears as large as 1200 mm in diameter and module 12.
- With technology and software to grind “Beveloid” (conical) gears, and tip and root relief without special dressing diamonds.
- We also excel at grinding gears as small as 2.0" in diameter.

WE ARE LOOKING FOR GEAR MACHINE OPERATORS.



**Ready to Excel?
Contact:**



815.623.3414 / www.excelgear.com

Motor Technology Makeover

Efficiency, Size, Space and Mounting Requirements Highlight Customer Requests for No Compromise

Matthew Jaster, Senior Editor

No compromise. No shortcuts. No cheap imitations. You get the point. The motor has to be exactly what the customer wants or they'll look elsewhere. They'll find what they need in a growing market that understands motor applications are evolving and the products and technologies need to follow suit.

Luca Bonguilielmi, head of business management EMEA at Maxon, sees an emphasis on miniaturization, the increased efficiency of drives and an increased focus on smart manufacturing and predictive maintenance for motors in 2019.

"Our customers demand solutions that fit their applications perfectly and meet all their requirements, as well as excellent service. As a result, we need to know the market and its regulations very well. For this reason, we have set up five business units to address the following markets: medical, transportation, aerospace, industrial automation and e-mobility & robotics," he said.

At Kollmorgen, Christopher Radley, senior manager, global platform commercialization, is also seeing an increased demand for solutions that specifically fit the customers' applications (as opposed to customers adapting manufacturer's standards to their application).

"This suits Kollmorgen well because we have a broad range of motor types (standard housed rotary servo motors, frameless, cartridge, direct drive, steppers, and linear) and we can quickly adapt standard designs to meet customer requirements or consider a completely new design," Radley said.

Words like "portable," "miniature," and "flexible," seem to come up in most discussions regarding motor technology today. Radley believes it's really all about getting an increase in performance without compromising on cost or efficiency.

There's also a question of control. Chris Moskaites, product manager—electromechanical solutions, Lenze Americas, says that customers would like much more of it.

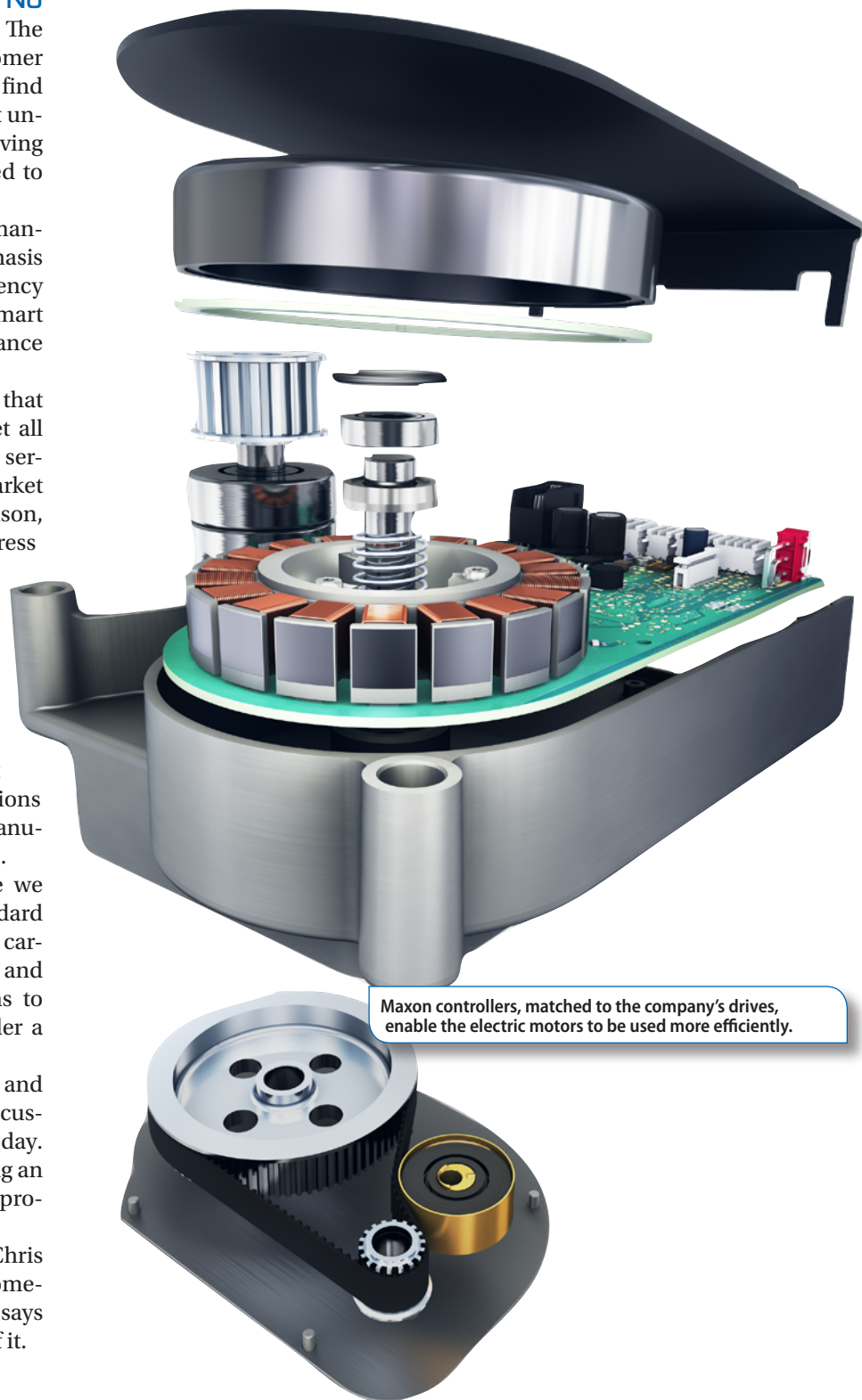

Maxon controllers, matched to the company's drives, enable the electric motors to be used more efficiently.

“They want simplicity, a reduced effort in motor design, installation and maintenance that will reduce engineering time by reducing the number of variants.”

This is where smart manufacturing comes into play in the motor market. Lenze’s Smart Motor, for example, offers the simplicity of a motor direct on line (DOL), but offers selectable speeds and ramps with a high overload capacity—a capacity that enables utilizing a motor that is two frame sizes smaller. Moskaites said this combination and torque profile is perfect for further enhancing horizontal conveying applications.

There is a current trend in the market toward defined start and stop ramps in order to improve the performance of conveying applications. There’s also a need to develop energy efficient solution that fulfill upcoming energy regulations from a technical perspective. Companies are challenged to reduce the time and effort required for dimensioning, design layout and installation, as an answer to increasingly shorter project timer. Finally, there is a demand for standardization and reduction of complexity, so that even large numbers of drives can be handled with little effort.

Moskaites said this is a large competitive benefit for the machine builder.

“They can standardize the cabinets as the components inside the cabinet will remain the same, no matter how many conveyors are connected to the line. In case an additional conveyor segment is required, the machine builder can add it easily through our distributed power bus concept, and only needs to tell the PLC that an additional segment is existing. Due to the electronics added to the motor the cabinet size can be drastically reduced as thermal protection and drive control are already included. And last but not least - if the customer needs to change the speed of the Smart motor on site, this is also no problem - it can be done by smart phone via NFC,” he said.

Maxon’s IDX is a new drive setup for industrial applications. “This is a modular drive system for applications in industrial automation or logistics

automation that consists of a motor and an integrated EPOS4 controller that can be used in a wide variety of applications. The IDX compact drives will be configurable online,” Bongulielmi said.

Kollmorgen’s ultra-strong permanent magnets and efficient electromagnetic designs help OEMs of equipment such as AGVs/AGCs/AMRs and cobots: Not only can they extract greater torque without increasing the

size of their equipment, but they can also do more work with the same battery life.

“Our industrial experience with Functional Safety, high precision/accuracy applications, and the ability to match specific industry interfaces, positions Kollmorgen to help these portable devices meet our customer’s 21st century requirements,” Radley said.

For standard housed rotary servo motors, Kollmorgen’s second-generation

A BROKEN CHAIN COSTS YOU

It's a chain reaction—a worn-down sprocket causes accelerated chain wear, which causes tension loss, drive slippage, a jumped chain, or worse. Save your chain...and money...by replacing your sprockets before critical component failure occurs. Tsubaki's Smart Tooth® sprockets have patented Wear Indicator Pins that let you identify when it's time to change so you can extend your chain life. Don't let a broken chain break your bank.

New sprocket Worn due to chain wear

Pins indicate when to replace your sprocket

ELIMINATE THE GUESSWORK
TSUBAKI® SMART TOOTH® SPROCKETS

Call today
(800) 323-7790

No more guessing when you change to SMART TOOTH®

ustsubaki.com

TSUBAKI

FORGING AHEAD OF THE PACK

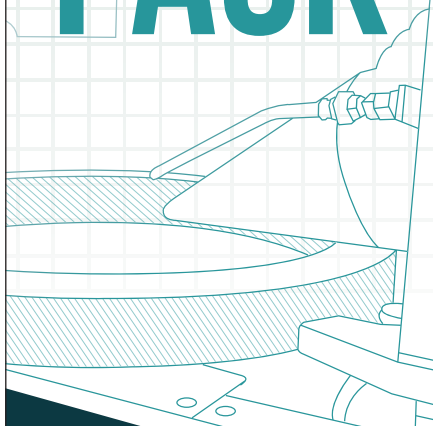

MADE IN THE
USA

**Fast.
No Fine Print.
No Premium.**

At McInnes Rolled Rings, we provide quality products, shipped fast. And we partner that with exceptional customer service to forge the perfect partnership with our customers.

**McINNES
ROLLED RINGS**

1.877.736.4409

www.McInnesRolledRings.com



The Kollmorgen AKM2G offers a new electromagnetic design, new mounting/housing design, and new materials.

AKM2G offers up to 30% torque increase in the same volume (frame-size and length) as the AKM.

This new design offers a new electromagnetic design, new mounting/housing design, and new materials; while increasing automation capabilities for manufacturability and testability, of the product without compromising modularity for design flexibility & customizations for low & high-volume customers.

Radley said that customers can replace existing motors without changing their mounting yet gain substantial performance improvements. Or, for customers looking to reduce machine/motor size, they can retain the same level of performance.

And what are the significant factors for a change in customer demand today?

“Optimization of the OEM machine design means every bit of space, every bit of power, every thermal consideration, feedback type, connector, mounting...it all matters. Customers aren’t looking to compromise. They are looking for an exact solution not one where unnecessary oversizing drives up cost,” Radley said.

Radley discussed additional factors including the fact that companies now have *global* requirements, therefore, motor solutions need to work in any geography and meet the local standards/approvals. Quick-turn prototypes are also a must in this market

today—even for exact-fit products. Customers require lead-times as short as standard product lead-times.

At the end of the day, most customers want capable sales people and the ability to talk directly to the design engineer,” Radley said. “Here’s what I need, when can you get me drawings, a prototype, etc.?”

Bongulielmi said that he sees projects are becoming more extensive and complex due to stricter regulations. The general trend is towards mechatronic drive systems—with a holistic approach.

“In other words, customers are increasingly reluctant to opt for a single DC motor but for an integrated mechatronic solution such as a robot joint. These designs often involve a battery and the solutions are becoming more efficient and more intelligent. In addition, the controller plays an increasingly important role in monitoring the drive.”

The different components are connected more strongly with each other in 2019, so communication becomes more and more important.

“Maxon Motor controllers are playing an increasingly important role in this respect. They are perfectly matched to our drives, which in turn is an advantage for our customers, as it enables our electric motors to be used more efficiently. The more we develop mechatronic systems, the closer we



STOCK DRIVE PRODUCTS/STERLING INSTRUMENT
a Designatronics company

ENGINEERING
MANUFACTURING
ASSEMBLY



GET COMPONENT OPTIONS AND DESIGN SOLUTIONS

Gears, Timing Belts & Pulleys, Bearings, Couplings, Hardware
Custom Mechanical Solutions | Precision Machining | 3D Printing

REGISTERED
ISO 9001
AS 9100

Stock Drive Products / Sterling Instrument
250 Duffy Avenue, Hicksville, NY 11801
Phone: (800) 819-8900 Fax: (516) 326-8827
email: sdp-sisupport@sdp-si.com
www.sdp-si.com

REQUEST A CATALOG

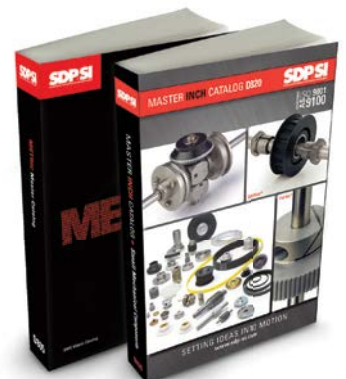

MOLON

MOTOR & COIL CORPORATION



CERTIFIED
ISO 9001-2015
ISO 13485



Motor Solutions Thru American Innovation

We don't leave the manufacturing and engineering of our products to other countries.

**AMERICAN
MANUFACTURER
EST. 1954**

VISIT OUR WEBSITE:
www.Molon.com

get to the end user of the application," Bongulielmi said.

Kollmorgen has long worked with customers to build what were once called higher level assemblies (integrated mechanical/electrical assemblies) and are now typically called mechatronics.

"Over time this has evolved from a focus on matching components to insure performance while reducing suppliers, to one in which the mechatronics is critical to achieving a result that would not otherwise be possible. We also see robotic joints as an example of this in which the gearing is integral to the frameless motor itself to maximize performance in the smallest possible footprint. This takes us from simply mating together existing independent parts to building a highly specific solution to match an application," Radley said.

Moskaites said that more customers are realizing the benefits of decentralized technology as a measure for cost savings and reduced engineering and labor time.

"Requests for the Lenze Smart Motor and Motec have increased. With five adjustable speed levels - and the infinite selection of rotating direction - definable start and stop ramps, as well as an electronic contactor and motor

protection function, the Smart Motor's integrated electronics eliminate the components, reversing contactor and motor protection circuits, as well as the polarity reversal required for mains motors, enabling real space savings," he added.

Like every other component in mechanical power transmission, motors have their own set of unique challenges.

Bongulielmi at Maxon returns to the discussion of service and delivery time.

"The speed of service and delivery has to be constantly high, at the same time quality must not decline," he said.

Radley cites a few other growing challenges. "IP protection is one. It takes a considerable time, effort and capital to engineer entire motor lines. Return on Invested Capital (ROIC) is also difficult if global competitors can simply reverse-engineer a design. You also have rising material costs that fly in the face of lower market prices."

As always, you can add the shortage of technical talent and expertise to the mix as well.

"Challenges in the industry today include the shortage of an educated workforce, compliance with mandated efficiency standards, complex engineering requirements and energy efficiency," said Moskaites.

There is a current trend in the market according to Lenze toward defined start and stop ramps in order to improve the performance of conveying applications.

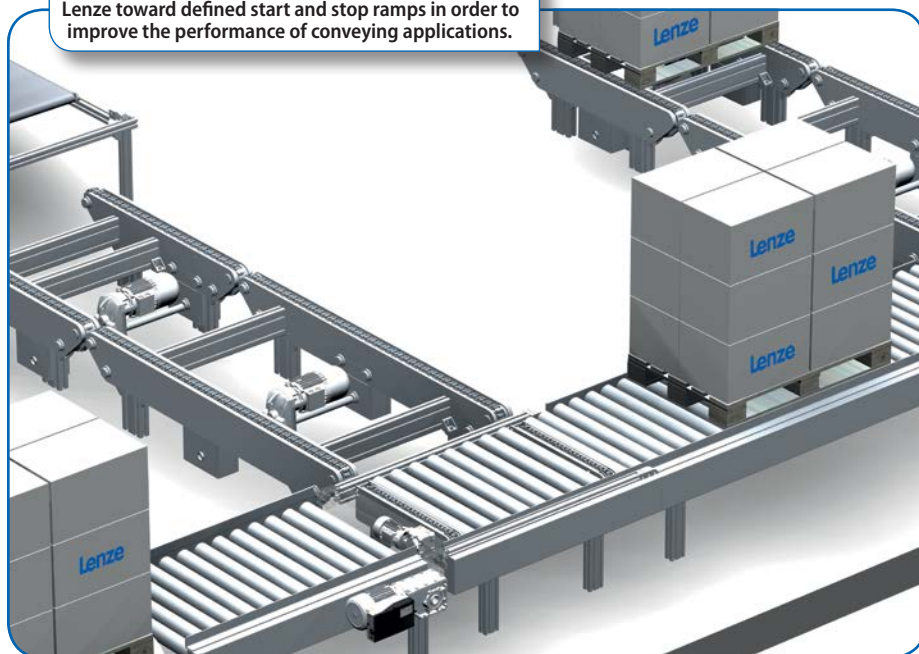



90 MISSILES

330 SAILORS

1,100 MILES OUT
TO SEA

**ZERO
ROOM
FOR GEAR
DRIVE
FAILURE.**



POWER SYSTEMS BY TIMKEN

Whether it's the frontline combat fleet of the U.S. Navy or your own gear drive operation needs, Philadelphia Gear delivers mission-critical performance and reliable, responsive support.

With unmatched expertise that's on call 24/7, plus complete warranty coverage on workmanship and material for any gear drive we service, including those from other manufacturers, we've set the standard in dependability — on land and at sea — for more than 125 years.

Keep your mission moving.

Visit PhilaGear.com/MyMission to learn more.

WD
BALL & ROLLER
BEARINGS

Quality Creates Value



PREMIUM BALL BEARINGS FOR ELECTRIC MOTORS

- High Speed
- Low Noise
- Low Vibration
- Ready Inventory



Call us for engineered solutions

888-334-3777

www.wd-bearings.com
WD BEARING GROUP

Maxon's IDX is a modular drive system for applications in industrial automation or logistics automation that consists of a motor and an integrated EPOS4 controller that can be used in a wide variety of applications.



For Related Articles Search

motors

at www.powertransmission.com

Many of these challenges may be solved with the trend toward more compact mechatronic solutions.

"Particularly as electrification—replacement of hydraulic and air—continues to increase.

We also expect greater migration to battery-powered portable equipment, in industries that are unexpected," Radley said. "We're inclined to believe there will be numerous breakthroughs in feedback: (a) lower-cost, higher-precision, and higher-temperature; (b) collapse of additional sensors such as accelerometers, temperature and humidity into the feedback device. We are always on the lookout for new magnet material and for new tools to increase flux focus."

Moskaites said there's going to be a continued emphasis on easy installation, commissioning and troubleshooting. "Also an increased emphasis on energy efficiency—including not only the motor but the complete gearbox and drive—in order to prevent an increase in costs."

Bongulielmi at Maxon said there will probably be more standard solutions, i.e. plug-and-play drive sets for defined markets. The customer should be able to integrate these systems into the application as easily as possible. This saves development time and brings the product to market faster.

"In addition, it will probably be possible in the future to buy the service and not the hardware - in other words, pay per use. This means that customers only pay for their drive systems when they are up and running," he added. "And last but not least, the development of motors will probably move more in the direction of high-torque direct drives."

In conclusion, there are plenty of factors and functions that customers want from motor and drive units in 2019. Thankfully, many of these requirements are being met with mechatronic solutions and smart manufacturing. Suppliers have a handle on size, space, efficiency and mounting concerns and know what needs to be provided on the component as well as the system level to appease each individual application. As areas like mechatronics and IIoT grow, suppliers will have a greater ability to provide solutions without compromise. **PTE**

For more information:

Kollmorgen
Phone: (540) 633-3549
www.kollmorgen.com

Lenze Americas
Phone: (508) 278-9100
www.lenze.com

Maxon Precision Motors
Phone: (508) 677-0520
www.maxonmotorusa.com

FOR UNSURPASSED QUALITY,
PERFORMANCE AND
VARIETY IN GEAR OILS....



LOOK TO LUBRIPLATE® GEAR OILS

Lubriplate's complete line of premium-quality gear oils has been formulated to deliver unsurpassed performance in a wide range of gear reducers. They meet and exceed the performance specifications of most gearbox manufacturers and interchange directly with most OEM oils. Available products include...

SYN LUBE SERIES 150 - 1000 100% SYNTHETIC PAO-BASED GEAR OILS

- High-performance, 100% synthetic, polyalphaolefin (PAO)-based gear oils.
- Compatible with petroleum-based oils and most seals for easy conversion.
- Available in ISO viscosity grades 150, 220, 320, 460, 680 and 1000.

SYN LUBE HD SERIES HEAVY-DUTY, EXTREME PRESSURE (EP) 100% SYNTHETIC, PAO-BASED OILS

- Super heavy-duty, polyalphaolefin (PAO)-based synthetic gear lubricants.
- Formulated to meet AGMA EP (Extreme Pressure) requirements.
- For Heavy-duty, high load applications where an EP oil is required.

SPO SERIES HIGH-PERFORMANCE, ANTI-WEAR FORTIFIED, PETROLEUM OIL-BASED, INDUSTRIAL GEAR OILS

- Petroleum oil-based anti-wear, rust & oxidation inhibited (R&O) gear oils.
- Can be used with silver alloy, copper, and copper alloy bearings.
- Premium quality, high-performance, petroleum oil-based gear oils.

SFGO ULTRA SERIES NSF H1 REGISTERED FOOD GRADE 100% SYNTHETIC, PAO-BASED GEAR OILS

- NSF H1 registered and NSF ISO 21469 certified - food machinery grade.
- 100% synthetic, PAO-based fluids for food processing and bottling plants.
- Available in ISO viscosity grades 150, 220, 320, 460, 680 and 1000.
- Fortified with Lubriplate's proprietary anti-wear additive **Xtremity®**

PGO & PGO-FGL SERIES ADVANCED 100% SYNTHETIC PAG-BASED GEAR OILS

- Ultra High-Performance, Polyalkylene Glycol (PAG)-Based, Gear Lubricants.
- ECO-friendly-Inherently biodegradable, provides long service life, energy conserving.
- PGO-FGL Series is NSF H1 registered and NSF/ISO 21469 certified food grade.

SYNTHETIC WORM GEAR LUBRICANT

- 100% Synthetic, ISO 460 grade, polyalphaolefin (PAO)-based worm gear oil.
- Formulated especially for worm gear applications.
- Provides excellent lubricity and oxidation resistance.

APG SERIES HEAVY-DUTY PETROLEUM OIL-BASED EXTREME PRESSURE (EP) GEAR OILS

- High-quality, petroleum-oil based, extreme pressure (EP) gear oils.
- Meets military specification MIL-PRF-2105E and MIL-L-2105D.
- Conforms to API categories GL-3, GL-4, GL-5, MT-1.

KLING GEAR OILS HEAVY-DUTY, TACKY RED, PETROLEUM OIL-BASED EXTREME PRESSURE (EP) GEAR OILS

- Heavy-duty, tacky, red, extreme pressure (EP) petroleum-based gear oils.
- These tacky, adhesive, extreme pressure oils cling tenaciously to gear teeth.
- Formulated for heavy equipment and heavy service industrial applications.
- Meets military specification MIL-PRF-2105E and API classification GL-5.



Lubriplate®
Lubricants

Newark, NJ 07105 / Toledo, OH 43605 / 800-733-4755
To learn more visit us at www.lubriplate.com



Backed By: **Lubriplate®**
ESP

Complimentary Extra Services Package

Plant Surveys / Tech Support / Training
Color Coded Lube Charts & Machine Tags
Lubrication Software / Follow-Up Oil Analysis

Motor Design for Aerospace Applications

George Holling

Modern aircraft, missiles and space vehicles employ a large number of electric motors and actuators. While the basic design of these motors is in many respects very similar to that of their automotive and industrial counterparts, motors for aerospace applications differ significantly in some areas.

Similar to automotive motors, the specifications for aerospace motors call for a wide operating and storage temperature range. For our discussion we will focus on electronic temperature specifications, as most electric motors would fall under those specifications. MIL-STD-810 is the primary environmental standard for U.S. military equipment. Military equipment can encounter ambient temperatures as low as -61°C ; the high temperature limit is often determined by the mounting location of such equipment and it may

require ambient operating temperatures well above 100°C . Aircraft can ascend or descend from sea level to 40,000 ft—or even higher in just a few minutes where they can encounter temperature changes of $\Delta 80^{\circ}\text{C}$ or more. Space vehicles may encounter low temperatures near the absolute zero of minus 273°C and very high temperatures when they are exposed to direct sun exposure and, again, the operating temperatures can change very rapidly. In some extreme cases, electronics and actuators may even have to be heated or cooled to allow them to operate in these harsh environments.

Not only must aerospace motors withstand these temperatures and



Cooling fan for navigation system.

these repeated rapid temperature cycles; they must also endure them very reliably over a very long period of time. Typical military storage requirements are 20 years of shelf/storage life, while the actual operating life may be shorter. Space vehicles, on the other hand, may



be designed for lifespans well beyond those—a formidable technical challenge. The very long shelf and operating life requirements place limitations on material selections, bearing grease, magnet materials etc., that we do not normally encounter in industrial—or even automotive—applications.

The closest to the aerospace markets are automotive actuators and motors which are designed to very high standards and generally tight specifications; but even those do not compare to the shock and vibration requirements that are typically required for aerospace motors designed to continuously handle extreme shock and vibration environments.

The main difference between these motors is rooted in the application itself. Most aerospace systems provide for redundancy, where each system has at least one backup system, which is very occasionally, but rarely, encountered in automotive or industrial systems.

It is in fact this design feature that differentiates the two applications the most. In order for a backup system to function, it is important that, if a failure were to occur, such a failure must not interfere with the operation of the backup system. Thus, a potential failure that can lock up the whole actuator mechanism is unacceptable.

Therefore, much of the design effort for aerospace motors focuses on “safe failure modes” that will allow the backup system to take over without interference, if required.

Therefore the magnetics of a motor must be designed such that a winding short will not “lock” the rotor; rather, the rotor must be able to spin—even when such a major failure occurs. Therefore, aerospace motors are often induction motors or reluctance motors where the rotor will spin freely in case of a winding failure or, if permanent magnets must be used, these will often be embedded so that the magnetic circuit limits the short circuit currents and forces.

Along these lines, critical aerospace motors are often designed as 4- or even five-phase count motors, which can allow for continued operation—even

if a single phase becomes inoperative.

Weight and efficiency are other important considerations for all aerospace motors. The designer will try to minimize weight by removing any unnecessary magnetic material. A significant design effort can be spent on analyzing the magnetic requirements (flux), as well as the mechanical strength and optimizing the design for minimal material content, including the very challenging

operating environment. It is not uncommon to spend many months fine-tuning an aerospace motor design for mechanical strength and endurance at minimal weight and volume, as opposed to an automotive design that is mostly cost-driven.

To achieve highest strength and efficiency, aerospace motors will employ different material choices compared to automotive motors. For the lamination steel, designers will often use



The Power of One²

Your Objective:
One face in perfect alignment with another. *For infinity.*

No problems. No distress. No delays.

That's the same objective you have for choosing your gear producer. Circle Gear's objective is to engage with every customer's objectives.

- ▶ **One to 1000 gears**
- ▶ **Customer designed or reverse engineered**
- ▶ **Gearbox repair, rebuild or redesign**
- ▶ **OEM or end-users**
- ▶ **ISO 9001:2015 Certified**

1501 S. 55th Court, Cicero, IL 60804
 (800) 637-9335
 (708) 652-1000 / Fax: (708) 652-1100
 sales@circlegear.com
 www.circlegear.com



Spiral and Straight Bevel Gears (*Cut, Ground or Lapped*) • Spur Gears • Helical Gears • Long Shafts • Herringbone Gears • Involute and Straight Sided Splines • Internal Gears • Worm and Worm Gears • Racks • Sprockets • ISO Certified



Partnering with QualityReducer to provide Gearbox repair, rebuilding and reverse-engineering.

Hiperco steel, which has much higher mechanical strength and better magnetic properties (higher flux density, lower losses) than comparable industrial/automotive lamination steel. But it will cost orders of magnitude more than common laminations. Also, the use of titanium (high strength and very light weight) is common in aerospace motors. Titanium has one added advantage: it is truly non-magnetic compared to “non-magnetic” steel

which does have magnetic properties which can result in losses in the motor — especially at higher RPM.

Another important difference between aerospace motors and industrial/automotive motors is that military applications and, in some cases, commercial aircraft components restrict the country of origin. Much of the underlying technology base is classified or ITAR-restricted at best, and cannot be shared with



Pump motor for an airborne compressor.

YOUR BEST SOURCE FOR METRIC

MOTORS, GEARBOXES & COOLANT PUMPS

many low-cost-producing countries. It therefore should be no surprise that aerospace motor are significantly more expensive than their industrial counterparts.

One of the current challenges in the aerospace supply chain is the emergence of counterfeit parts that are lower cost, but also often fail to meet the stringent requirements of the original OEM components. This presents a great safety hazard, and to date there is no reliable way to ensure the origin of these parts in the supply chain. Unfortunately, this is not just a loss of revenue but also literally a matter of life and death. The U.S. Department of Defense and industry are working hard to find solutions. **PTE**



LAFERT NORTHAMERICA

Toll Free: 1.800.661.6413 Fax: 1.905.629.2852
www.lafertna.com Sales1@lafertna.com

Copyright Lafert North America 2017. All rights reserved.

EASA
The Electro-Mechanical Authority

AWEA
AMERICAN WIND ENERGY ASSOCIATION

PTDA
Member

For Related Articles Search

aerospace

at www.powertransmission.com

With over 70 publications and 9 U.S. patents on sensorless and efficient motor controls and low-cost power circuits to his credit, **George Holling** (PI) is an in-demand consultant to many major U.S. and International corporations for motors and drives. At present he holds significant influence in two companies — as technical director of Electric Drivetrain Technologies (2011– present) Moab, UT and as CTO of Rocky Mountain Technologies (2001– present), Basin, MT. Holling is a graduate of the University of Aachen, earning his B.S. (1974), M.S. (1978) and Ph.D. degrees there, while picking up his MBA at the University of Wisconsin.



A BELT FOR ANY APPLICATION

WE HAVE AN ANSWER FOR THAT

Continental has the products and know-how to solve any drive system issue – from synchronous belts and banded V-belts to specialty belts for variable transmissions. We'll even create customer-specific drive solutions for industrial equipment. To see our full line of power transmission belts and sprockets, visit continental-industry.com.

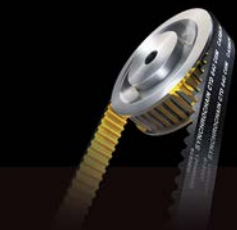

CONTI® Synchronchain Carbon

Heavy-duty timing belt for all extreme, ultra high-power applications with very high torques.



SilentSync®

This self-tracking belt is designed for very quiet and reduced vibration operation.

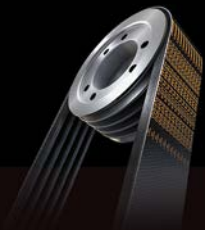

Torque Team® Plus

A narrow cross-section jointed belt with aramid cords for the toughest high horsepower drives.



Falcon Pd™

Reinforced rubber belt with superior resistance to flex fatigue and noise reductions up to 6 dB.



HY-T Wedge

Designed for high speeds over small pulleys and short center distances. Ideal for multiple V-belt drives with high-shock and heavy-duty loads.

Chain & Sprocket Systems and Maintenance

Richard Knotek, Motion Industries, and Derek Glugosh, US Tsubaki

Chain and sprocket drives of one form or another have been driving machines and conveying materials for over a thousand years. The chain manufacturing industry has developed numerous types and sizes of drive chains. Although it is a mature form of power transmission, there are still many industrial applications for which drive chain is suited. It is economical, resistant to shock loads, easy to install, has the ability to transmit high torque, operates in hostile environments, and is efficient. Chain and sprocket drives are highly engineered and manufactured within close tolerances.

Chain Function

Chain can be grouped into two functions: material handling and power transmission. Some chains are used for both purposes. If the chain is transferring or conveying raw material or finished products, it is considered a material handling chain. If the chain's primary purpose is transferring power from one shaft to another, it is for power transmission. In some applications, special attachments — for moving materials — are part of a power transmitting chain's construction.

The chain drive system consists of a driving sprocket, one or more driven sprockets, and a loop of chain. A sprocket is a wheel that on the outside diameter has evenly spaced, uniformly shaped teeth, which provide positive engagement with the chain. Because the chain is hinged at every link, it is able to wrap around the sprockets' teeth, connecting the driver and driven units.

Power and torque are transmitted from the drive sprocket mounted on the shaft of the prime mover, and then connected to one or more driven sprockets by the chain. As the chain drive system operates, every link in the chain undergoes "cycle loading."

The working or tight side of the chain is under full tension, while the slack side is under minimum tension. The sprockets, turning on their respective shafts and connected by a chain, deliver the power or transfer the load to accomplish work.

During operation, a phenomenon known as "chordal action" occurs in a chain drive system resulting from the fact that chain link is a straight-line segment trying to follow the circular path of the sprocket pitch diameter. Because the line of approach of the chain is not tangent to the pitch circle, it is lifted to the top of the circle and then dropped down. There is a surge of force in the chain caused by the change in speed as it makes this rise and fall. An increase in chain velocity can aggravate this event, resulting in vibration and pulse loading in the system. Excessively worn parts may amplify this effect.

Standard roller chain is the most common type of drive chain used in industry. ANSI & ISO maintain standards for design, dimensions, and interchangeability. Pitch, distance from center of pin-to-pin, roller diameters, width, and load ratings are defined. Standard roller chain is made up of alternating roller links and pin links. Each link is constructed by placing rollers onto bushings and pressing roller link plates onto the bushings. The side plates into which two pins are pressed, hold the rollers and bushings in place. The assembly is secured by the press fit between the pins and the plates (often accompanied with a rivet on the end of the pins), spring clips, or cotter pins through holes in the end of the pins.

Chain & Sprocket Alignment

Proper alignment within the recommended tolerances prevents premature component wear. It also reduces



Figure 1 A simple go-no-go gauge set is a great tool for determining when to change the chain (image courtesy of US Tsubaki).

For Related Articles Search

chain drives

at www.powertransmission.com

the loads that are applied to the supporting shafts and bearings.

A simple straight edge, wire, or laser system can be used to align the sprockets. Sprocket shafts should be parallel. The offset of sprocket faces should be $< .0625$ "/foot of shaft centerline distance. Angularity should be $< \frac{1}{2}$ degree. Axial run-out (wobble) of sprockets should be $< .001$ "/inch of diameter.

Chain and Sprocket Inspection

Check the condition of the drive components. The articulation of chain as it enters and leaves the sprockets causes the pins and bushings to wear, and the chain will gradually elongate. This is sometimes referred to as "chain stretch." The wear of a chain may be minimized by proper lubrication and maintenance procedures. Some wear is inevitable and normal. Measure the chain and if elongation is greater than 2% (.24" in one foot), replace the entire chain. Operating beyond the 2% elongation maximum recommendation

will cause the sprockets not to engage properly and may cause damage to the other components in the system. A simple go-no-go gauge set with machined steps (see Figure #1) is a great tool for determining when to change the chain. Do not join a new section of chain to a worn section because it may not operate correctly. Check the side plates for wear due to misalignment or cracks from fatigue. Make sure all chain joints are free to articulate and not stiff or frozen. Inspect carefully for signs of corrosion.

Sprocket Wear

Sprockets should be closely examined for wear. Loose or wobbly sprockets on the shaft can indicate a worn bore, key, or shaft, and this improper fit could result in catastrophic failure. Light interference fits or the use of a tapered bushing system are recommended for most normally loaded applications. Wear on one side of the sprocket plate usually indicates misalignment. Wear

We're Flexible



We provide flexible world-class gearing for hi-tech applications.

Our gears allow greater torque in less space with reduction flexibility and positive backlash control. Spiroid's unmatched skew-axis, high torque gears enable world-class power density.

SPIROID
HIGH TORQUE GEARING

Visit online to learn more.

SpiroidGearing.com

ROBOTICS • AEROSPACE • DEFENSE • TRANSPORTATION • MEDICAL

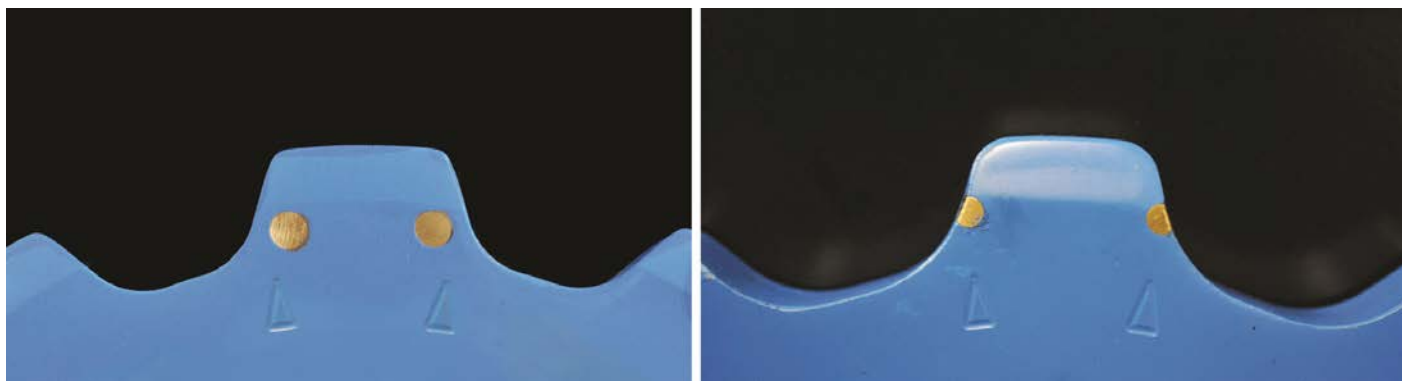

Figure 2 Wear indicator sprockets provide a maintenance technician with a visual warning of excessive wear (image courtesy of US Tsubaki).

on the working faces of the sprocket teeth may indicate a problem of inadequate lubrication. Watch for scratches, galls, grooves, or visible changes in the tooth form such as hooked or shark-fin shapes. Replace all worn and broken parts. Running a new chain on old sprockets will result in early failure of the chain. Worn sprockets damage associated equipment and will create vibration in the system.

The use of indicator-type sprockets in recent years is a major breakthrough in determining the point when a sprocket should be replaced. (See Figure #2.) By using a sprocket with strategically placed wear pins on the thrust faces of the tooth, the maintenance technician has a visual warning of excessive wear. It allows for the scheduling of maintenance rather than run-to-failure. (These sprockets are available in a wide range of sizes and types.)

Without a wear indicator, it was anybody's guess as to what was acceptable. When a chain would jump, the usual course of action was to treat the symptoms by shortening the number of links, and not deal with the cause, worn sprockets. This may keep the chain from coming off but increases the load on the bearings and doesn't eliminate vibration.

Lubrication

Roller chain is a series of interconnected plain bearings that requires lubrication to resist wear, cushion impact, dissipate heat, flush away contaminants, hinder corrosion, and provide a film between chain & sprocket contact surfaces. There are special lubricants formulated for use with chain drives that are designed for sliding friction and

don't leave a varnish or gummy deposits. Heavy oils and greases that are too stiff will not flow to the needed areas. The important point is for the lubricant to be clean and applied properly, based on the application. There are four basic methods to apply oil to the chain drive. Manual/ spray can, drip or brush, static oil bath, continuous circulating oil system that is filtered. The application, speed, and horse-power determine the best method to use.

For operations wherein conveyed materials must be free from contact with oil, lube-free chains are an option. This type of chain does not require additional lubrication, as it uses oil-impregnated sintered bushings. The use of this chain decreases maintenance costs and reduces product contamination, which is ideal for food and beverage applications and operations where lubrication is not possible.

Chain Tension

Proper tension for drive chain is extremely important. When chain is too tight, the additional load results in excessive wear on the chain joints and sprockets. Extreme tension also imposes additional loads on the bearings and shaft. When chain is too slack, vibration, noise, wear, shock loading occurs on the system. If the chain is excessively loose, it may jump off the sprockets. A good rule of thumb is a 1/2" of slack or mid-span movement for every 10" of drive center distance. If the drive orientation is vertical, then the allowable amount is one-half of that recommendation.

Conclusion

The sum of parts is equal to the whole when it comes to a roller chain drive system. Worn parts that are not replaced correctly in a timely manner will cause a 'chain-reaction' resulting in ancillary damage to connected components, increased labor, higher maintenance costs, more unscheduled downtime, and potentially an inferior manufactured product. Check your chain & sprocket drives often. **PTE**

For more information:

Motion Industries
Phone: (800) 526-9328
<https://bit.ly/2WwVnyX>

US Tsubaki
Phone: (800) 323-7790
www.ustsubaki.com

Derek Glugosh is a sprocket product manager with Tsubaki of Canada Limited and U.S. Tsubaki Power Transmission, LLC. He has worked for five years with Tsubaki as a product manager involved in a variety of

projects including product enhancements, new product development and rebranding. A former graduate of Brock University, Derek has 14 years of product management experience in both the power transmission and building products world.



Richard R. Knotek is a technical training specialist with the Motion Institute, a division of Motion Industries. He has worked 45 years with Motion Industries, holding a variety of positions including driver, inside sales, operations manager, salesman, branch manager, and product specialist. A former adjunct instructor with Northern Michigan University's Industrial Maintenance Program, Knotek is also the published co-author of Mechanical Systems & Principles (ISBN 0-13-049417-8).



cti symposium^{CN}



AUTOMOTIVE DRIVETRAINS



INTELLIGENT



ELECTRIFIED

8th International Congress and Expo
23 – 25 September 2019, Shanghai, China

The expert summit that drives mobility.

GET INSIGHTS FROM THE
MAIN PLAYERS ON THE MARKET (E.G.)



Dr Hongzhong Qi,
Chief Technology Officer,
GAC R&D Center, China



Dr Shemin ZHANG,
Director of
Powertrain Development,
Dongfeng Motor Company, China



Michael Schöffmann,
Head of Internationalization,
Region Management, Localization,
Audi AG, Germany

SPONSOR

PUNCH | Powerglide

www.drivetrain-symposium.world/cn



JIE
ASIADrive

NO WORRIES

www.jie-drives.com
Info@jie-drives.com | 630 580 9966

Inline Helical Speed Reducers

An extremely compact design provides highly reliable, space saving performance for the most demanding applications.



- 14 sizes, 1 - 75 HP
- Multi-stage Ratios
- NEMA, IEC, or Servo Motor Adapters
- High Efficiency & Low Backlash
- Multiple Mounting Configurations

DIEQUA
Corporation

diequa.com/pte 800-280-5402



B&R
MACHINE AND GEAR CORP

BRGEAR.COM

High Performance Bevel Gearboxes

The Tandler Spiral Bevel gearbox is both precise and ideal for demanding applications where robustness and high torque density are required.



- 9 sizes
- 15 ratios
- Low backlash
- Customizable

DIEQUA
Corporation

diequa.com/pte 800-430-1439

INCORPORATED

Nordex.com Sales@nordex.com Eng@nordex.com

Phone: (800) 243-0986

or Call: (203) 775-4877

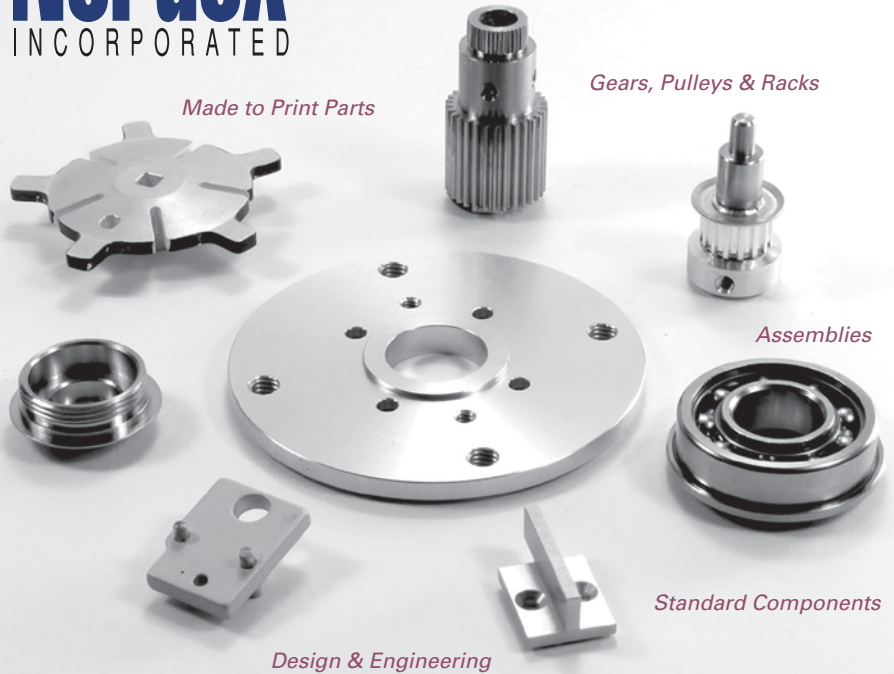

Contamination.
Bacteria Growth.
Frequent & Harsh Wash
Down Conditions.



**Cleveland Gear
Stainless Steel Reducers...
the Answer to your Food
& Beverage Application
Problems.**

3-4 Day Delivery
Built to order in USA



CLEVELAND GEAR
www.clevelandgear.com

P 800-579-6632 F 800-579-6645

Engineering sMart

is your resource for the latest in great ideas from our advertisers. Check this section every issue for sMart Engineering ideas and technology.

For information about
advertising, contact
Dave Friedman
at

(847) 437-6604

or

dave@powertransmission.com.

Advanced Belt Drive Systems

Enhancing Safety, Quality, Delivery and Cost

Taylor Jung, Director, Global Product Line Management - Industrial Synchronous Drives at Gates Corporation

The definition of lean manufacturing boils down to one simple principle—maximize productivity by reducing waste. The process to achieve waste reduction is to eliminate the non-essential components of production to increase efficiency, effectiveness and ultimately, profitability. In industrial businesses and manufacturing companies, one important way to reduce waste is to evaluate the key components of the manufacturing process including safety, quality, delivery and cost (SQDC) practices.

Many manufacturers find significant opportunities for improvement when they evaluate whether or not their current power transmission systems, such as roller chain and gearboxes, are the most optimal solution for their organization. While historically roller chain equipment has been used across industries, it has a number of limitations. With advances in materials, technology and process engineering, many operations are modernizing their equipment, breaking with the past, and switching to advanced belt drive systems. Whether you are already considering a conversion to belts or are an OEM designing a new manufacturing system, synchronous belts are steadily emerging as the new standard for power transmission as they consistently deliver improved safety, enhanced quality, streamlined delivery and are extremely cost effective.

Synchronous belt drive systems can offer many advantages over alternatives. Image courtesy of Gates Corporation.

The Gates Poly Chain GT Carbon belt is designed to improve safety and reduce noise.

Improved Safety

Your people matter—to both your business and your bottom line. By identifying and eliminating potential hazards, you not only improve employee working conditions, you increase productivity and maximize operational efficiency.

Roller chains require significant, hands-on maintenance, introducing the opportunity for a variety of employee safety risks. Installation demands employees work with extremely heavy chains that can be difficult to maneuver and position, leading to muscle strains or crush injuries. To then operate effectively, roller chain requires continual lubrication, either via a manual lubrication process or an oil bath, further increasing the possibility of employee accidents, such as slips and falls, or even a facility fire. Moreover, the nature of the maintenance process itself can lead to substantial and even life-limiting injuries such as lost fingers or limbs.

Another challenge with roller chain, especially in larger manufacturing facilities, is that it can be quite loud. Aside from creating an unpleasant working environment, habitual exposure to loud noise puts employees who don't wear hearing protection at risk for noise-induced hearing loss. Yet insisting employees wear hearing protection isn't the end-all be-all solution as it's often described as a nuisance that can limit communication between employees, leading to inefficiencies, errors and even injuries.

Making the switch from a chain to a belt immediately improves the safety conditions for your employees and your operations. Belts require zero maintenance as they do not stretch, eliminating the need for re-tensioning work, and do not need lubrication. This means that with a belt drive the oil-related safety concerns are no

longer an issue, reducing overtime maintenance demands on your people. For example, after converting to a belt drive, an asphalt company in New England no longer had to incur the risk, and significant cost associated, to rent a crane every few months for employees to perform maintenance on its roller chain systems. The elimination of this dangerous and time consuming process, much of which had to be completed outside of production hours, has helped the company save on their maintenance budget, reduce overtime demands and help improve mechanic and operator retention.

Belts also weigh less than their chain counterparts. The Gates Poly Chain GT Carbon belt, for example, is 97% more light-weight when compared to chain. The lighter weight helps improve ergonomics, reducing employee fatigue and strain, making installation, general maintenance and replacement much more manageable. The risk of crushing and pinching injuries caused

by heavy chain is also eliminated. Synchronous belt drive systems also run quiet. By reducing the exposure to loud noise and decreasing potential issues due to limited communication capabilities, belts improve operating conditions and create a more pleasant work environment.

Enhanced Quality

Many manufacturers produce high-quality products that, through critical processes, are required to meet certain industry specifications and regulations. In the food and beverage or pharmaceutical industry, contamination during the production process is unacceptable and can lead to standing inventory, wasted product or recalls. It is imperative that equipment remains clean and the reduction of contamination is a top priority. Food handling spaces, for example, require constant washdowns which can cause rust contamination. Not to mention, the cleaning process often washes away the



lubrication required for chain to function properly, creating a continuous need to re-lubricate. It's a vicious, and potentially costly, cycle.

One solution to reduce the risk of contamination and improve the quality of your products is to use synchronous belt drives in facilities that operate within the highly regulated industries that produce food, beverages, pharmaceuticals or delicate textiles. Since belts are inert to most acids, chemicals and water, they are an ideal solution for wet environments; belts are also easier to clean and more resistant to microbial contamination. Thermoplastic polyurethane (TPU) belts are specifically designed for these types of environments and adhere to higher health and safety standards, meeting the FDA material requirement for wet food contact and can be USDA certificated for hygiene requirements in meat and poultry processing equipment.

For manufacturers of small components, conveyor belts must combine accuracy and speed to support

precision indexing. While achieving this level of automation is possible with roller chain, it can be both difficult and costly to maintain performance. Synchronous belts are again an optimal choice to replace chain, as they do not stretch over time and have optimized profiles to deliver the lowest backlash solutions.

Effective Delivery

Maximizing operations and productivity is often dependent on modern, automated industrial equipment. For many manufacturers, outdated power transmission systems, like chain and gearboxes, are stifling production line advancements. Gates Poly Chain belts allow manufacturers to innovate and differentiate with diverse solutions for operational challenges. With narrow drive packages and the ability to support high-torque applications, belts are an ideal solution in situations that require maximum product output, but have limited space constraints. Gates' belts have extended lengths — up to 20

meters — making it possible to replace heavy roller chains and large gearboxes that have not been previously addressable by belt solutions. Gates' belt lines also include many different options to meet a variety of pitch, size, temperature and conductivity requirements.

Having quality solutions that meet your specific requirements increases factory uptime, enhances production and ensures your customers get exactly what they need. This is why it is especially important, if you are making the conversion to belts, to align with a partner that has the knowledge and experience to fabricate a system to that is right for you. To keep up with changing customer demands, investing in the right solution to fit your needs is paramount.

Cost Efficiency

In addition to the benefits listed above, enhancing workplace safety, streamlining internal processes and improving quality control measures also impacts your bottom line.

Advanced belt drive systems allow



One synchronous belt can drive many pulleys in a serpentine arrangement. Image courtesy of Gates Corporation.

you to eliminate many occupational safety hazards, improving employee and facility safety, while reducing overtime maintenance demands, resulting in a more satisfied workforce with reduced organizational risk and liability. And seeing as much of the maintenance of roller chain involves oil, belts can also eliminate the risk of regulatory fines due to oil spills and leaks which can cause ground or water contamination. Choosing the right power transmission solution for your products and industry will increase productivity with fewer production issues and enhance the quality and value of your products.

Requiring zero maintenance, belts also often last three times longer than the average chain. The Gates Poly Chain GT Carbon belt, for example, uses a patented combination of highly engineered carbon fiber tensile cord and a low-friction nylon tooth surface to increase the life span. Lower maintenance work and longer product life both reduces the costs associated with employee maintenance activities and increases factory uptime, allowing organizations to produce more with the same equipment.

While investing in a belt drive conversion does require an upfront cost, the payoff will outweigh the investment and decrease your total cost of ownership over the long term. Upgrading to a synchronous belt drive, for instance, will easily pay for the replacement costs in 6–12 months, depending on the industry. Installation of a belt drive solution in new equipment brings immediate value to the user and can be a point of differentiation for the manufacturer.

For example, a sawmill, generating 650,000 board feet a day of lumber, found it was spending roughly \$30,000 every 18 months in equipment and operational costs to replace the output shaft on its gearbox. The company decided to convert to a belt drive system, and, while the original purchase price for the system was similar to that of a gearbox, that same system has been operational for six years with no downtime or breakage. Having gained incredible cost efficiency, the company is gradually converting all its gearboxes to multi-stage belt drive reducers.

Making the Switch

The benefits of converting to an advanced belt system, replacing roller chain or gearboxes, are clear - especially for organizations interested in the lean manufacturing process. As you determine your next steps, I recommend you weigh the initial cost of conversion to the increased safety, quality, delivery and cost effectiveness you will likely experience over time. You may be surprised how much your organization will benefit. **PTE**

Taylor Jung is the Director of Global Product Line Management at Gates, responsible for industrial synchronous drives. He leads a team that identifies strategic segment market opportunities and develops the product specifications required to achieve and maintain product leadership in those chosen spaces. Taylor's experience in sales, marketing, operations and engineering enables alignment across global teams to deliver the most innovative and differentiated solutions in the marketplace. Prior to Gates, Taylor held a technical sales role at Trane. He earned a B.S. in Chemical Engineering from the University of Colorado.



For Related Articles Search

belt drives

at www.powertransmission.com



BROWSE OUR BLOGS!

PTE features three blogs to keep readers updated on the latest PT trends, technologies and industry solutions:

Bearings with Norm: Norm Parker is Global Senior Specialist – Roller Bearings at FCA US LLC and offers various insights and technical knowledge on the bearing industry.

Motor Matters with George Holling: The technical director at Rocky Mountain Technologies regularly contributes articles regarding motors, power quality, power factor, efficiency and more.

Editor's Choice: Our editorial staff provides relevant and timely articles on a variety of PT industrial topics.

Visit

www.powertransmission.com/blog/

to learn more.

Documentation of Gearbox Reliability — an Upcoming Demand

Dr. Ing. Ulrich Kissling, Dr. Ing. Michael Stangl

The proof of the reliability of a gear drive is now an additional requirement. In Europe, the acceptance authorities for wind turbines are requesting a system reliability proof from gearbox manufacturers. The AGMA committee reviewing the AGMA 6006 standard for wind turbines is considering adding a chapter about “design for reliability.” However, reliability considerations are not new; NASA, for example, was in the 1980s using reliability concepts for gear drives.

Most standardized methods used to assess the strength of gearbox components such as gears or shafts lead to a safety factor that expresses the ratio of permissible stress to effective stress. The permissible stress is determined based on a failure probability of the material strength value determined during the measurement of the S-N-curve.

In mechanical engineering, a safety factor greater than 1.0 does not always imply “safe” or less than 1.0 “not safe.” It also depends on other reasons, as, for example, the consequences of a failure if a certain safety factor level is considered as safe or not. Therefore, it is quite difficult to understand the result of a gear strength analysis. For a drivetrain, the situation is even worse in that gear strength is expressed in safety factors for bending, pitting and scoring — but bearing strength is expressed in lifetime. So how is it possible to deduce if a drivetrain is safe?

Although these individual procedures for the design of a single component are very handy, it lacks an easy statement about the failure probability of the full system. This is aggravated by the fact that the intrinsic failure probability of the methods for different components varies. This paper presents a method to transfer the safety factor of each component into a failure probability based on a Weibull distribution — taking material properties into account. After this step it is easy to obtain a probability function for the failure of the full system over lifetime. Based on this, a statement such as “the probability of a failure of the gearbox within 20,000 hours is less than 0.2%” can be made.

The paper describes in detail how for the main gearbox components — gears, shafts, bearings — the strength results according to standards can be transformed in a Weibull failure probability distribution. The method can be applied to all standard calculations according to ISO, DIN and AGMA — which are based on an S-N-curve. It can be used for calculation with nominal load or duty cycles.

To determine the reliability of the drive system, the transmission elements are categorized: Is the failure of an element directly causing the gearbox failure? Is there redundancy?

Thus, the system reliability can be determined with the components’ reliabilities.

Symbol	Notation	Units
R	Reliability (of a single component)	%
R_s	Reliability of system	%
t	Number of load cycles	
t_0	Number of load cycles without failure (no failure during the t cycles, from the beginning)	
T	Characteristic service life (in cycles) with 63.2% probability of failure (or 36.8% reliability)	
fac	Number of load cycles per hour (conversion of operating hours into load cycles)	1/h
B	Weibull form parameter	
f_{tB}	Factor according to table 2	
H_{att}	Achievable service life of the component (in hours)	h
H_{att10}	Achievable service life of the component with 10% probability of failure	h
F_o	Specific probability of failure (for calculation of H_{att} according to table 1)	%

Design Life

Typically, machines are designed for a certain lifetime, as, for example, 20,000 hours. So, the design engineer will lay out all the components of a machine based on such a request. But the methods used to check if a component fulfills the request vary.

For gears, the normal calculation method, e.g. — ISO 6336 (Ref.4) — will provide, based on the requested life and the applied torque, a safety factor for bending and pitting. For bearings, the calculation method (per ISO281 (Ref.3)) will provide the attainable lifetime. For gears, the obtained safety factor must exceed a larger-than-requested minimum safety. The requested safety could be 1.0; but is often — depending on prescriptions by specific application rules — higher than 1.

Basically, for all other machine elements such as shafts, bolts and housings, the verification methods are also different. Calculation methods for mechanical parts were usually developed by different specialists working at different technical institutions. All these strength analysis methods have one thing in common, i.e. — they determine the stresses created by the applied loads and then compare these stresses with the permitted stresses. However, the calculation procedures differ greatly, depending on what type of machine element is involved (for example — bearings, shafts, gears or bolts). So, a check if all components of the verified object fulfills the requirements needs of specific knowhow.

Failure Probability of Machine Elements

All of the above methods have one major weakness in common in that they are based on an intrinsic failure probability that differs from method to method (Table 1). So if a shaft has a calculated safety factor of 1.2 and a gear root has a safety factor of 1.3, it is not clear which is the more critical component.

A material strength value with a failure probability of 90% is higher than a material strength value with a failure probability of 99%. Therefore, if the 90% failure probability is applied, the safety factor is greater and the element has both a greater service life and a lower damage rate for its design life; damage that is calculated using methods prescribing different failure probabilities cannot be compared directly. A gear unit may fail because of a part that is not considered to be critical breaks prematurely; this happens quite frequently in real life.

To overcome this problem, the reliability concept can be used. Here the result is a curve that shows the probability of failure of a component or a system over the lifetime. When statistical parameters, such as the scatter of results in a standard distribution, are determined based on measurements on probes, a probability of failure as a function of time (or cycles) can be determined using a statistical approach. The opposite of the probability of failure is called “reliability.” Therefore, since the reliability calculation takes into consideration the inherent failure probability (Table 1), the calculated reliability at design life of different parts can be compared effectively with each other. Also, at a given probability level the component with the smallest achievable life is the critical component of the system.

Probability Distributions

In statistics, probability distributions are used to describe stochastic processes (see numerous textbooks, e.g. (Ref. 8)). A probability distribution is a function that gives the likelihood of an event for a specific value of a probability variable. In our case the event is failure (or survival) and the probability variable is the number of load cycles.

The reliability function $R(t)$ gives the probability of survival until t load cycles. For the definition of a probability distribution the first derivative $R'(t)$ is defined, i.e. — the so-called density. The density is a function that defines the probability of the event happening at a given number of load cycles.

The most common distribution for general purposes is the normal distribution. This distribution is defined by the mean value μ and the standard deviation σ . The standard deviation σ controls how wide the distribution is. However, although for small σ the density looks like it becomes zero with enough distance from the mean, it never actually does. So also for negative values of t ; there is a positive likelihood that failure occurs. Due to these limitations the normal distribution is not very often used in reliability engineering.

A more general approach is the Weibull distribution, in which two variants are possible — the two-parametric and the three-parametric Weibull distribution, where the two-parametric is a special case of the three-parametric.

Table 1 Probability of failure used by various calculation methods when determining material properties

Shaft, DIN 743	2.5%	Assumed, not documented
Shaft, FKM guideline	2.5%	
Shaft, AGMA 6001	1%	If $k_c = 0.817$
Bearing, ISO 281	10%	If factor $a_1 = 1.0$
Tooth flank, ISO 6336; DIN 3990	1%	
Tooth bending, ISO 6336; DIN 3990	1%	
Tooth flank, AGMA 2001	1%	If reliability factor $K_R = 1$
Tooth bending, AGMA 2001	1°/0	If reliability factor $K_R = 1$

Table 2 Factors for a Weibull distribution according to Bertsche (Ref. 2)

	factor f_{tB}	Weibull form parameter b
Shafts	0.7 to 0.9	1.1 to 1.9
Ball bearing	0.1 to 0.3	1.1
Roller bearing	0.1 to 0.3	1.35
Tooth flank	0.4 to 0.8	1.1 to 1.5
Tooth root	0.8 to 0.95	1.2 to 2.2

The two-parametric Weibull distribution leads to the reliability function

$$R(t) = e^{-\left(\frac{t}{T}\right)^b} \quad (1)$$

where T is the characteristic lifetime (defined by the condition $R(T) = 0.632$) and b is the shape parameter.

The three-parametric Weibull distribution has t_0 as a third parameter, which shifts the first occurrence of failure to the point t_0 by the substitution

$$t \rightarrow \tilde{t} - t_0 \quad (2)$$

This substitution gives the reliability function

$$R(t) = e^{-\left(\frac{t-t_0}{T-t_0}\right)^b} \quad (3)$$

Determining the Reliability of Machine Elements

There are currently no mechanical engineering standards that include the calculation of probability. A classic source for this calculation is Bertsche’s book (Ref. 2), in which the possible processes have been described in great detail. Bertsche recommends the use of the 3- parameter Weibull distribution.

Parameters T and t_0 can be derived from the achievable life of the component, H_{att} , as follows (with failure probability F_o according to the calculation method from Table 1, b and f_{tB} from Table 2 according to Bertsche):

$$T = \left(\frac{H_{att} - f_{tB} \times H_{att10}}{\beta \sqrt{-\ln\left(1 - \frac{F_o}{100}\right)}} + f_{tB} \times H_{att10} \right) \times f_{ac} \quad (4)$$

$$t_0 = f_{tB} \times H_{att10} \times f_{ac} \quad (5)$$

with

$$H_{att10} = \frac{H_{att}}{(1 - f_{tB}) \times \sqrt{\beta \frac{\ln\left(1 - \frac{F_o}{100}\right)}{\ln(0.9)}} + f_{tB}} \quad (6)$$

Equation 1 for $R(t)$ can now be used to display the progression of reliability over time (or number of cycles) as a graphic.

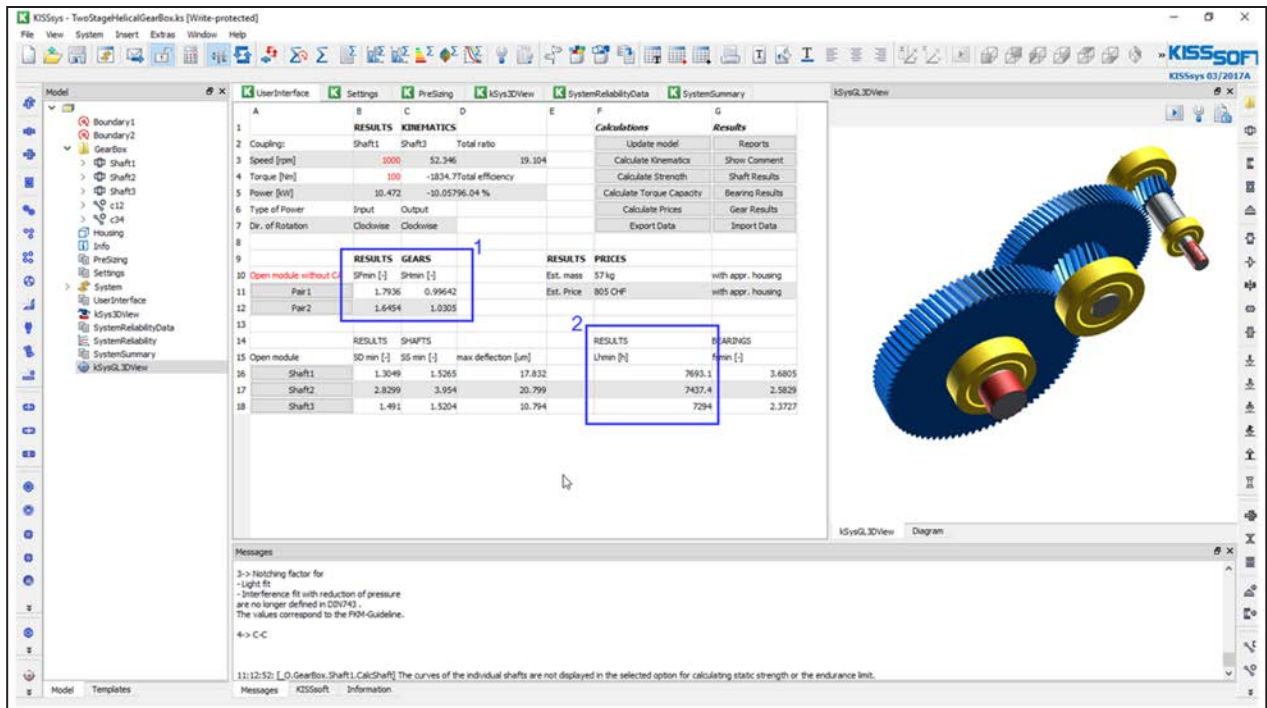

Figure 1 Example of gearbox modeled in KISSsys.

The load cycle values t_0 and T can then be calculated based on a service life calculation. Equations 4-6, using the achievable service life H_{att} , can be used for this purpose.

An Example

To illustrate the differences between the concept of safety factors and reliability an example is shown. Figure 1 shows the model of a two-stage gearbox in KISSsys (Ref. 6). The design life is 5,000 h, so the critical component appears to be gear 1 with a flank safety factor of slightly below 1.0 (0.996) — see

box “1.” The bearings have a calculated lifetime of above 7,000 hours — see box 2 — and thus seems to be on the safe side.

However, looking at the reliability graph in Figure 2, the situation is different. The left-most first curve of individual components is the one for gear 1, confirming the previous assessment. But this is only true for relatively low probabilities; the lower horizontal red line is on the 90% probability level. Here, gear 1 has indeed the shortest lifetime. Still, this is above the required 5,000h design life — which is marked with the vertical grey line.

At 99% probability, the bearing life is much lower — about 3,000 hours. This is marked with the upper horizontal red line; indeed, the most critical components are the bearings.

Determining System Reliability

Determining the overall reliability of a gear drive is of primary concern for all important drives. In particular, people who are not technical specialists are not particularly interested in knowing which is the critical bearing in a drive; they are much more concerned about the drive’s service reliability over a predefined period of operation. However, the reliability of individual elements in a gear unit must be used to determine the reliability of the overall system.

The functional block diagram of the gear unit must be analyzed before the reliability of individual components is used to calculate overall reliability. In order to determine system reliability, the gear unit elements are classified according to their significance, i.e. — if the element fails, does it directly cause the failure of the entire gear unit? Or are redundancies present? The overall reliability of the entire system can then be determined by mathematically combining the reliability of the individual components.

In particular, a distinction must be drawn as to whether the significant components are connected in series or in parallel.

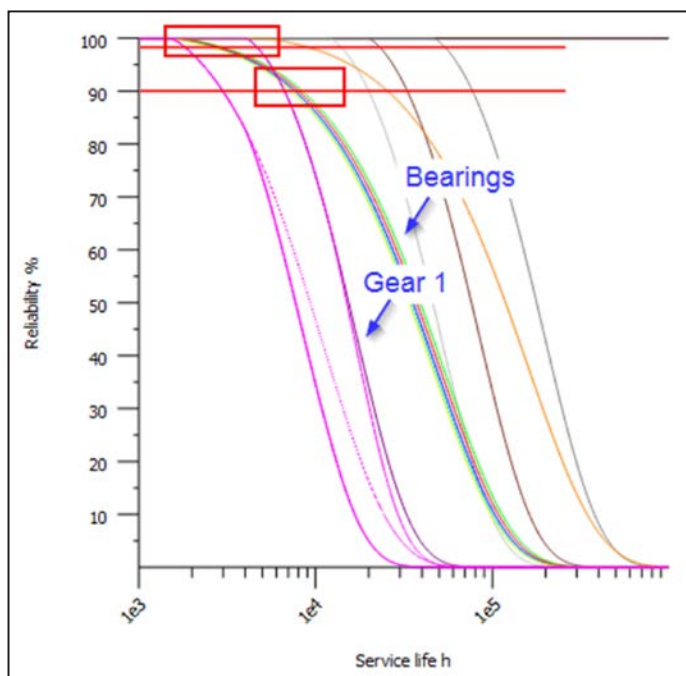

Figure 2 Calculated reliability curves.

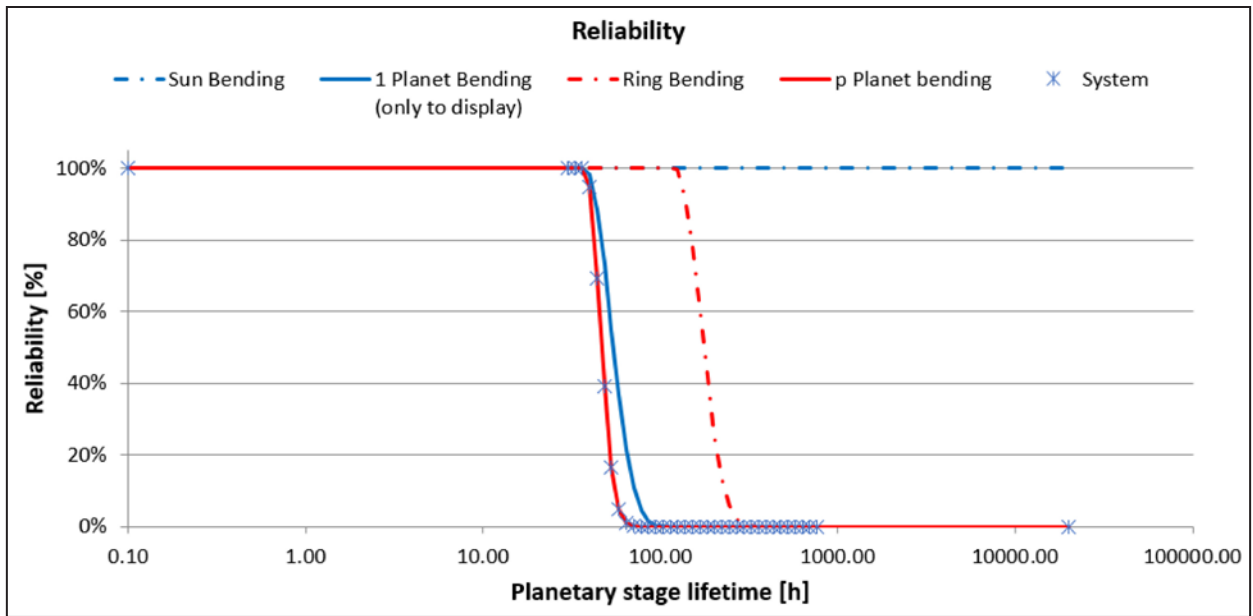

Figure 3 Reliability diagram for a planetary stage with 3 planets; the 3 serially accumulated planets are critical. The system reliability is virtually identical to the reliability of these 3 planets because the ring and the sun have a significantly higher degree of reliability.

Although this appears to be complicated at first glance, it is usually quite straightforward for most gear units. If any of the vital elements in a standard gear unit (bearing, shaft, gear) break, this will cause the entire gear unit to fail. This means that all these elements are connected in series. Gear units designed with redundancies are not commonly found in practice. In this design type, the power flow runs through two parallel branches within the gear unit. If an element within one of the branches fails, the other branch continues to run the unit as a whole.

The following equation can be used to determine system reliability for serial functions:

$$R_s(t) = \frac{R_{c1}(t)}{100} \times \frac{R_{c2}(t)}{100} \times \dots \times \frac{R_{cn}(t)}{100} \times 100 \text{ or } R_s(t) = 100 \times \prod_{i=1}^n \frac{R_{ci}(t)}{100} \quad (7)$$

Bertsche (Ref. 2) has also developed formulae for the less-commonly found cases for units with redundancies (parallel branches).

Reliability for Gear Pairs and Planetary Stages

Gear pairs and planetary stages will be discussed here as an introduction to examine entire systems; these types of configurations are sub-systems in themselves. The procedure for a classic gear pair is quite straightforward: the overall reliability is the product of the four “elements” — tooth root (f) and tooth flank (h), for the pinion (1) and the gear (2) in each case:

$$R_{pair}(t) = \frac{R_{f1}(t)}{100} \times \frac{R_{h1}(t)}{100} \times \frac{R_{f2}(t)}{100} \times \frac{R_{h2}(t)}{100} \times 100 \quad (8)$$

In planetary stages, the power flow is distributed across the planets. Theoretically, the planetary stage could

continue working — even if one planet fails — because of the built-in redundancy of this design. Theoretically, therefore, the planet stage is connected in parallel. However, in practice the failure of one planet (gear or bearings) usually means that metallic fragments penetrate the tooth meshings and bearings, and thus cause other parts to fail. For this reason, these elements have to be considered as connected in series. The reliability of the planetary stage can therefore be determined as follows (p : number of planets):

$$R_{pstage}(t) = \frac{R_p(t)}{100} \times \frac{R_{h1}(t)}{100} \times \left(\frac{R_{p2}(t)}{100} \times \frac{R_{h2}(t)}{100} \right)^p \times \frac{R_{R}(t)}{100} \times \frac{R_{S}(t)}{100} \times 100 \quad (9)$$

A publication by NASA (Ref. 7, Eq. 43) about the reliability of planetary stages confirms the proposed method. The authors use the same approach for calculating overall reliability, but without providing justification as to why they use the serial formula for the planets.

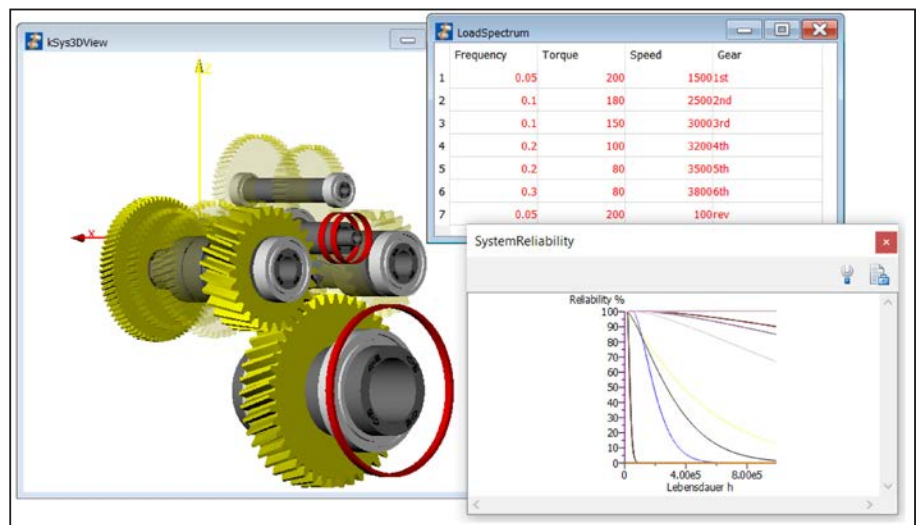

Figure 4 Modern dual-clutch gear unit with a load spectrum (6 forward gears and one reverse gear); system reliability displayed with a linear scale.

System reliability. The major benefit of using reliability as a parameter for qualifying the gear elements is that it is a quick and relatively simple method for determining system reliability. In *KISSsoft* (Ref. 6) the achievable service life is also calculated every time a verification is performed. Consequently, the data for each individual element of the gear unit is automatically available. This data is then forwarded to a system program as *KISSsys* (Ref. 6). System reliability can therefore be determined at system level. In addition to showing overall reliability, the weakest elements in a gear unit are also clearly displayed in this type of diagram.

In the case of vehicle gearboxes, the calculation for components must be performed with a complex load spectrum that also takes into account the shift setting (shifted gear, time, torque and speed) (Fig. 4). This calculation determines the service life of all the components, and the reliability can be derived from these values. The calculation of system reliability also assumes that the components are switched in series. Obviously, if, for example, the second gear fails, the vehicle can still be driven in a different gear. However, this should be regarded as a hypothetical scenario that would apply in an emergency.

System reliability is of critical importance for gear units used for wind turbines (Fig. 5), because any repairs are very expensive. Wind turbine manufacturers therefore require their gear unit suppliers to provide very extensive proofs. Proofs of system reliability are already a requirement in this sector (Ref. 1). AGMA 6006 (Ref. 5), a U.S. standard for wind power gear units, is currently under revision. It is likely that this revised version of AGMA 6006 will include a new method for calculating system reliability — the very first mechanical engineering standard to do so.

Outlook

Displaying an analysis of gear drive strength in terms of system reliability can easily be understood by people who do not have a detailed knowledge of the modern calculation methods used for gearbox components. It is also the only method that can be statistically evaluated and used to make a comprehensive assessment (gear unit will stop/will not stop) with a corresponding level of probability. This method has become increasingly popular and widespread, but a number of problems still remain; for example: should the inclination of the S-N curve in the limited life range affect the Weibull form parameter β ? As yet no reliable approaches to this problem have been documented and additional research is needed.

As mentioned, AGMA 6006 (Ref. 5), a U.S. standard for wind power gear units, is currently under revision. Since the first version of this standard appeared in 2003, it has been used as the basis for the currently valid international IEC/TC 88 standard for gear units used in the wind power generation industry. It is likely that this revised version of AGMA 6006 (Ref. 5) will include a new method for calculating system reliability — the very first mechanical engineering standard to do so. We can then presume that the AGMA will propose this type of method in the IEC/TC 88 workgroup as a supplement to IEC 61400 “wind turbines” regulation.

Summary

Modern calculation methods based on S-N curves can be used to analyze every essential element in a gear unit. These methods determine the achievable service life of the gearbox elements, which in turn can be used to calculate the Weibull distribution for reliability.

The reliability of a gear drive can be determined by calculating the reliability of the gear unit components. The use of reliability as a parameter for assessing a gear unit is currently

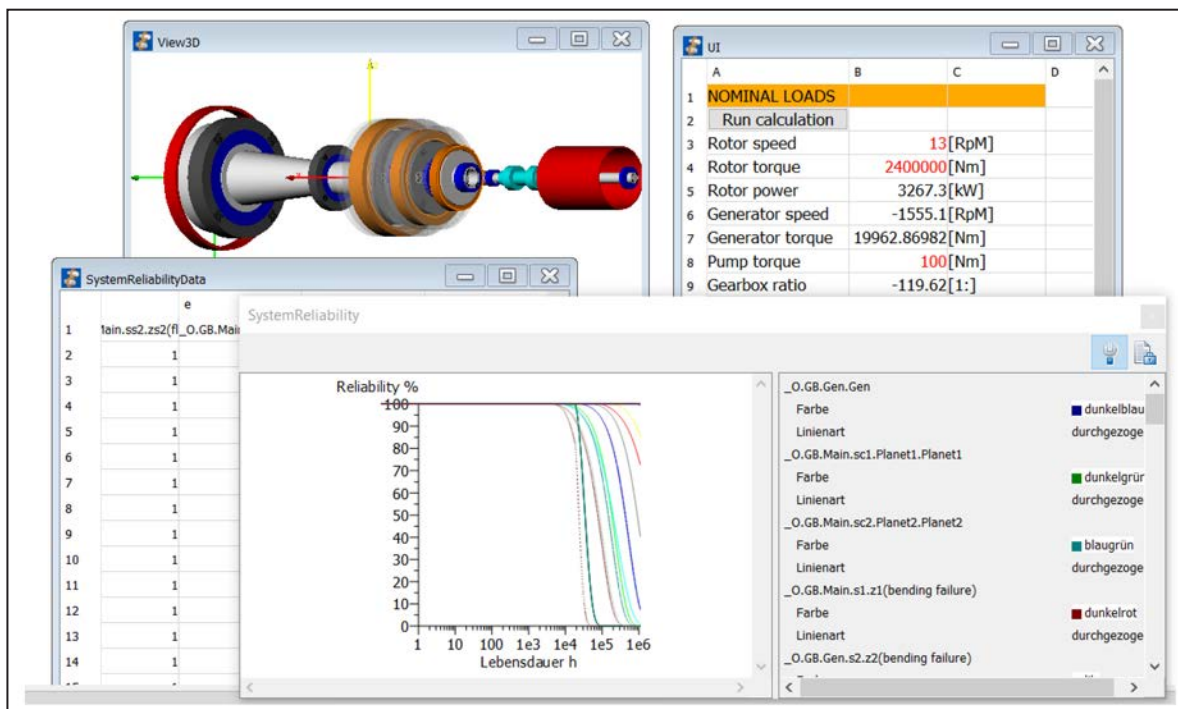

Figure 5 Wind power gear unit with its reliability.

becoming a popular method, and could well be a requirement in the near future for gear units used in wind power generation.

People who are not technical experts will find this method of displaying reliability much easier to understand than a table of achieved safeties for gears and service life values for rolling bearings. They do not need to understand that material properties that comply with ISO 6336 have a 1% failure probability, or that the calculated service life of bearings has 10% failure probability. Nor do they need to know that a higher minimum safety is usually prescribed against tooth bending than against pitting. All these different approaches can be used together to provide a well-balanced statement of reliability, with values that really can be compared with each other. However, when a design review expert is provided with these types of calculations he must (maybe even more so than before) still check exactly which conditions, for example — which minimum safeties — have been used to determine reliability. **PTE**

For more information.

Questions or comments regarding this paper?
Contact Ulrich Kissling at ulrich.kissling@kisssoft.ag.

Literature

1. Falko, T., D. Strasser, et al. Determination of the Reliability for a Multi-Megawatt Wind Energy Gearbox; VDI Report no. 2255, 2015.
2. Bertsche, B. "Reliability in Automotive and Mechanical Engineering; Berlin, Heidelberg," Springer Verlag, 2008.
3. ISO 281. Rolling Bearings — Dynamic Load Ratings and Rating Life, ISO, 2007.
4. ISO 6363 Capacity of Spur and Helical Gears. ISO, 2006.
5. AGMA 6006-B??: Revision of the Standard for Design and Specification of Gearboxes for Wind Turbines; AGMA, 2003, Restricted Document.
6. KISSsoft/KISSsys. "Calculation Programs for Machine Design," www.kisssoft.ag.
7. Savage, M. and C.A.Paridon. "Reliability Model for Planetary Gear Trains," NASA Technical Memorandum, 1982, www.dtic.mil/dtic/tr/fulltext/u2/a119165.pdf.
8. Bronstein/Semendjajew: Taschenbuch der Mathematik, Sixth Edition, Harri Deutsch Verlag, 2005.

Dr. Ulrich Kissling studied machine engineering (1976-1980) at the Swiss Technical University (ETH), where he also completed his doctoral thesis — "Pneumatic Weft Insertion on Weaving Machines. In 1981 he started his professional career as calculation engineer for a gearbox manufacturing company in Zurich, progressing there to technical manager and ultimately managing director. As a calculation engineer for gearbox design, he began developing software for gear, bearing and shaft layout. In 1985 he branded this software 'KISSsoft' and started to market it, selling its first license in 1986. In 1998 he founded his own company — KISSsoft AG — concentrating on software development and growing staff from three people in 1998 to workers in 2017. Today, aided by the contributions of partner and managing director Dr. Stefan Beermann, KISSsoft is the leading drivetrain design software, used by more than 3,000 companies on all continents. An internationally respected gear expert, Dr. Kissling is chairman of the TK25 committee (gears) of the Swiss Standards Association (SNV) and a voting member for Switzerland in the ISO TC 60 committee. He actively participates in different work groups of ISO for the development of international standards.



Dr.-Ing. Michael Stangl is currently developer at the KISSsoft AG and head of KISSsys development group. He obtained his doctors degree in 2006 at the FZG at the technical university of Munich in his work about calculation of planetary gears. In his free time he enjoys cooking, sailing, reading and playing music.



Hungry for More?



Power Transmission Engineering

Everything you need if you buy gears, bearings, motors, couplings and clutches.

FREE SUBSCRIPTION!

www.powertransmission.com

Pros and Cons of Different Bearing Lubrication Methods

Vladimir Harutyunyan

Lubrication plays a vital role in the performance and in the life of bearings. The functions of the lubricants are to reduce friction and wear, to dissipate heat, and for ferrous-based bearings, to prevent rusting.

There are bearings that are “lubricated for life” and bearings that need to be re-lubricated.

“Lubricated for life” bearing is a bearing that does not need re-lubrication over its normal service life.

For a maintenance crew, it is important to know which bearings need re-lubrication and make sure they are lubricating those bearings.

The bearings can be lubricated manually or by automatic lubrication systems. This article will review each method and discover its pros and cons.



Fig. 1 Manual grease gun.

Manual Lubrication

Pros

- Easy access. This method is good, when your bearings are easy to access and it is safe for the operator. These types of applications are not time consuming and will cost much less than automated systems.
- Inspection while greasing. Many maintenance managers prefer manual greasing to make sure their equipment is getting inspected. Having an automatic lubrication device doesn't mean that the system won't require any inspection, but a lot of places don't have proper inspection procedures, so lubrication is a reason to go and check the equipment as well.

Cons

The cons of manual lubrication are many. Since it is done by human beings, there are many things that can go wrong:

- The No. 1 reason that bearings fail prematurely is the improper amount of grease (overgreasing and undergreasing). Certain parts of equipment that are easy to access may get greased too many times and hard-to-reach areas may never get greased. The lubrication team must have proper training on how often and how much the equipment should be greased.
- Using the wrong lubrication can cause a premature failure because of grease incompatibility (not all greases are compatible with each other) or the incorrect grease for the application. Proper training and procedures are necessary for lubrication teams to know which grease goes where.
- Safety is an issue of concern, when doing a manual lubrication. In a lot of instances the lubrication points are in places where people can easily hurt themselves. For this reason, safety training is a must, when doing manual lubrication.
- Hard-to-reach lubrication points can be very time-consuming. Sometimes to reach certain lubrication points the technicians have to disassemble the equipment. This increases the cost of lubrication. For certain places lubrication tubes can be used, but not always.
- In many applications, grease fittings can be covered in contaminants, and you can never perfectly clean them up, which causes the contaminants to get injected into the bearing along with the grease. It is very easy

to damage or break the seals with grease guns (due to high pressure generated by grease gun). Also, contaminants can easily penetrate into damaged seals.

Automatic lubrication systems

Pros

- Protection from overgreasing and undergreasing. With automatic lubricators, the amount of grease is set over a period of time. The bearings are getting the grease and they are getting the right amount. This way no lubrication point is missed or forgotten.
- The chances of confusing the lubricants are less than with manual greasing.
- Increased safety. With automatic lubrication, the technicians don't have to get to unsafe places like in the case of manual greasing.
- Labor Savings. Automatic lubricators can save a lot of time, especially for hard-to-reach lubrication points.
- Less contamination is introduced, due to increased maintenance intervals. Most of the automatic lubricators don't have enough pressure to damage the bearing seals. This reduces the chance for contaminants to enter into the bearing due to damaged seals.
- Optimized lubricant delivery (Fig. 2).

Cons

- Investment cost. Of course, implementing an automatic lubrication system requires some level of investment. To maximize the return on that investment, the key is to choose the right solution based on the requirements and criticality of the application. Typical solutions range from inexpensive single-point automatic lubricators to very complex centralized systems with various options for online monitoring.

Let's take a look at the pros and cons of single-point lubricators and multi-point systems.

Single-Point Lubricators

Pros

- Single-point lubricators are suitable for remote locations.
- They don't require initial high investment cost as for centralized systems.
- They are easy to install and maintain.
- No long lubrication lines

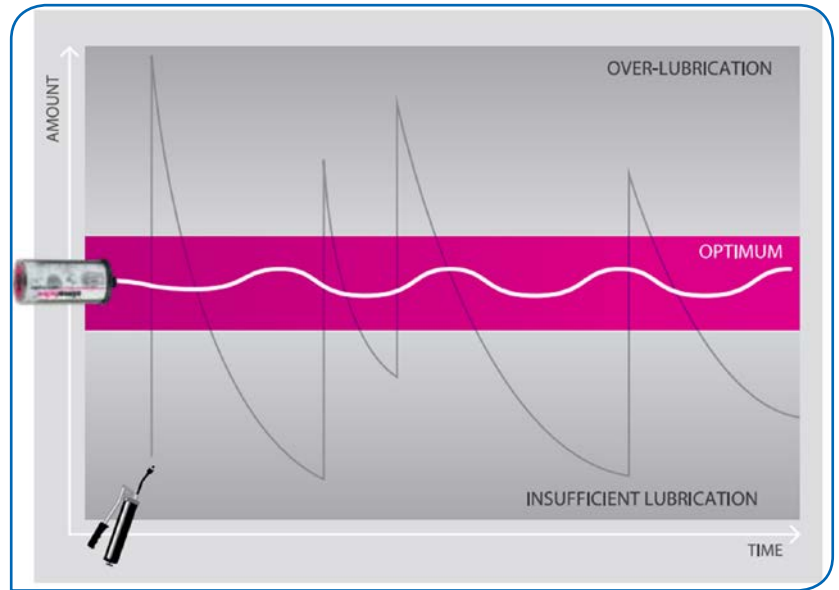

Fig. 2 Optimized lubricant delivery. The picture compares manual lubrication with automatic. The pink area is the optimal amount of lubrication inside the bearing. As you can see, the automatic lubrication is maintaining the right amount of lubrication over time. Image courtesy of Simatec Inc.



Fig. 3 A single-point lubricator. Image courtesy of Simatec Inc.

Cons

- Most of the single point lubricators are of single use, so after they dispense the grease you need to purchase again.

Multi-Point Lubricators**Pros**

- Some production plants have many lubrication points in one area. In such cases, it is more effective to have one centralized system to lubricate all the bearings in the area.
- Over time the cost may be less than single-point installation. After initial setup, technicians just have to fill the reservoir.
- Multi-point can generate much higher pressure than single-point, hence it can have longer tube lines to lubrication points. This is convenient in hard-to-reach areas.

Cons

- Much higher initial cost than with single-point lubricators.
- Proper inspections are needed. For hard-to-reach points, sometimes lines may break under high pressure. The bearing will not receive any lubrication and eventually will fail. The grease from a broken line may drip on the product or somewhere else where it not should be.

In summary, there is no perfect answer regarding which method is better. It all depends on application, maintenance crew, industry and other conditions. There are plants that use single-point lubricators, multi-points and still do manual greasing as well. **PTE**

For more information

HVH Industrial Solutions
Phone: (866) 577-4040
www.hvhindustrial.com

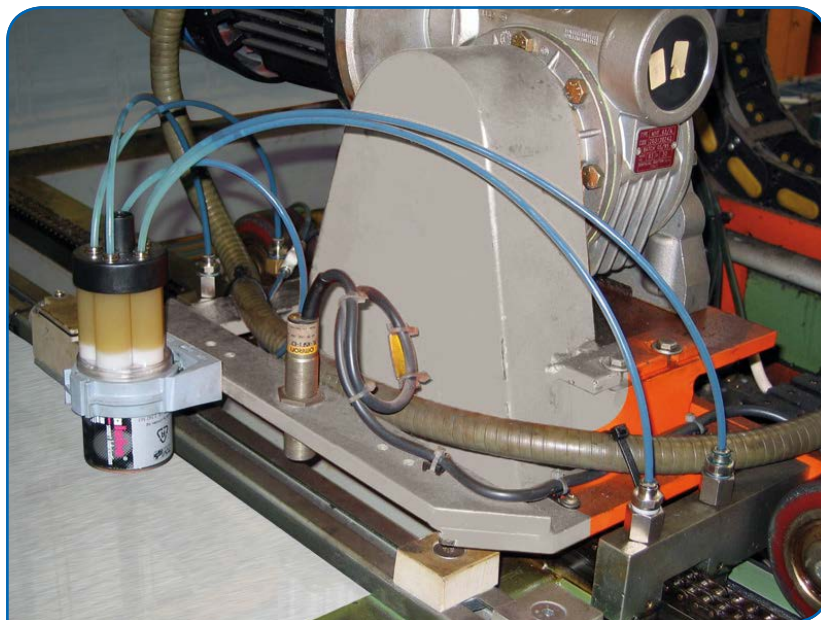

Fig. 4 A multi-point lubricator. Image courtesy of Simatec Inc.

Vladimir Harutyunyan is the president of HVH Industrial Solutions, a leading provider of power transmission parts.



For Related Articles Search

bearing lubrication

at www.powertransmission.com

MISSING A PIECE?

We've got you covered! Go to powertransmission.com to see what you missed in last month's issue, plus another eleven years of back issues, industry and product news, and more!

In last month's issue:

- **Bearings**
- **Clutches**
- **Brakes** ... and more!

Power Transmission Engineering

Nord Gear

CELEBRATES 40TH ANNIVERSARY IN THE UNITED STATES WITH 6TH EXPANSION

Delivering double-digit sales growth for three consecutive years, Nord Gear Corporation is expanding for the sixth time since it built its North American headquarters in Waunakee, Wisconsin in 1983. This year, Nord is also celebrating its 40th anniversary in the United States. The global company began U.S. operations in 1979 in nearby Middleton, Wisconsin, sharing a building with Fristam Pumps — a continuing long-time customer.



Nord's newest expansion will add 86,000 square feet of office and manufacturing space. This will help Nord increase the company's capacity and ensure a continued short lead time delivery. The company currently delivers 22 percent of customer orders same day or next day, and 44 percent within five working days, including custom orders. Nord's main products include gearboxes, motors and frequency inverters as well as industrial gear units.

Expanding its U.S. production capabilities, Nord also added a \$6.2 million building expansion and new paint line in Wisconsin last year. Torsten Schultz, Nord's U.S. president, explained, "We continue to grow, so we almost tripled our capacity with our new paint line. On a daily basis, we currently assemble on average 650 gear units and 300 motors." He added, "We're also expanding our facility on Charlotte, NC by 15,000 square feet this year."

Schultz said one of the reasons for Nord's success is its strong engineering support and customer service. The company employs about two dozen engineers that help customers create solutions for their power transmission challenges. "Our top business growth areas are in the warehouse logistics, airports, food and beverage industry, and the grain industry," he explained.

"So whether customers are designing new baggage handling systems, conveyors for warehouses, or mixing tanks for food processing, Nord offers engineering support."

In Waunakee, Nord employs 325 people. Across the United States, Nord employs nearly 425 people.

"With our continuing growth, we're always looking for talented people to join our team." He concluded, "Come grow with us. We offer a great work environment for customer service, administrative, sales, technical and production people."

Information about Nord and career opportunities are listed on the website below. (www.nord.com)

Freudenberg Sealing Technologies

ANNOUNCES COO RETIREMENT

Freudenberg Sealing Technologies recently announced that chief operating officer (COO) **Dieter Schaefer** will retire June 30, 2019. Schaefer, who is widely praised for his contributions to Freudenberg's intense focus on quality and digitalization, has agreed to consult with the company for an additional two years upon his retirement.

"We thank Dieter Schaefer for his extraordinarily successful work during his nearly 20 years at Freudenberg and look forward to his continued support. The concepts of operational excellence and continuous improvement in manufacturing have been inseparably associated with him at Freudenberg Sealing Technologies. Under his leadership, we have significantly increased the company's performance capability and manufacturing efficiency — and thus product quality — through the systematic use of such methods as Lean and Six Sigma," said Claus Möhlenkamp, chief executive officer (CEO).



He went on to praise the COO's other contributions. "Schaefer also recognized the potential of digitalization for our company early on and, among other measures, standardized large portions of the purchasing process. With the integration of industrial software into our production processes, he laid the foundation for Freudenberg Sealing Technologies' success today. This has uniquely positioned the business group for success around the globe."

Upon Schaefer's retirement, the Freudenberg Sealing Technologies board of management will be restructured from four to three members. Claus Möhlenkamp will continue as chief executive officer with responsibility for strategy, sales, human resources and communication. Ludger Neuwinger-Heimes will continue as chief financial officer (CFO) in charge of finance, information technology (IT) and mergers and acquisitions. Dr. Theodore Duclos, chief technology officer (CTO), will continue to oversee the company's innovation

management, process technology, product and material development, quality management and occupational health and safety. In addition, Duclos will also take over Schaefer's responsibilities as COO and will direct the operations, lean, supply chain management and purchasing areas.

Schaefer studied business administration at the University of Münster and then served in professional posts in Germany and abroad for the Hoesch, Kabelmetall and Jungheinrich companies. In 2001, he joined Freudenberg Sealing Technologies, the largest business unit of the Freudenberg Group, and initially worked in various leadership roles in manufacturing and as a plant manager. In 2005, Schaefer was promoted to head of Freudenberg's Special Sealing Products business area before taking over the largest area of the company: the oil seals division, whose best-known core product is the Simmerring. Schaefer has been a member of the Freudenberg Sealing Technologies' board of management of the since 2012. He is married and has three adult children. (www.freudenberg.com)

Sulzer

SIGNS PARTNERSHIP WITH KATO ENGINEERING

Following on from the recent agreement with Nidec for the sales and servicing of medium voltage variable speed drives, Sulzer has signed a partnership deal with Kato Engineering to provide repair and maintenance services for generators in North America and Australia.

Sulzer has considerable expertise in generator repair as well as providing maintenance services to customers for turbines, compressors, pumps, motors and gearboxes, so adding the Kato generator range will provide greater product coverage. Similarly, the level of expertise offered to existing Sulzer customers will now be available to all those operating Kato generators.

The Kato range of generators is in operation extensively in the oil and gas, mining and power generation sectors. As such, they provide vital power supplies and their continued reliability is enhanced by periodic maintenance and planned repair. Now, these services will be more accessible by using Sulzer's global network of service centers, which are equipped to deliver fast and cost-effective solutions.



BEYTA GEAR SERVICE

**PUTTING
A LIFETIME
OF
GEAR
DESIGN
EXPERIENCE
TO WORK FOR YOU**

- Reverse engineering
- Gearbox upgrades
- Custom gearbox design
- Specification development
- Project management
- Vendor qualification

- Design reviews
- Bid evaluations
- Tooling design
- Customized gear training
- Equipment evaluation
- Custom machine design

Charles D. Schultz
chuck@beytagear.com
[630] 209-1652

www.beytagear.com

Quicksilver Controls

silverMax™

Integrated Hybrid Servos

Motor + Encoder + Controller + Driver

High Efficiency Over Wide Speed Range

Highly Programmable

Handles Large Inertia Mismatch

NEMA 23 and 34

Bringing Our 23 years of Hybrid Servo Expertise to Your Project!

+1 909 599 6291

www.QuicksilverControls.com

Nicolas Troussard, head of business development electromechanical services, explains: “As a reseller, distributor and an authorized service center for motors and generators, Sulzer has a global presence that can offer many benefits to customers with equipment from Nidec and Kato. This agreement brings Sulzer’s expert maintenance capabilities in close proximity to Kato’s customers, giving them access to local expertise and support. For Sulzer, it reinforces the product offering for our existing customers, and it strengthens our position for distributed power applications in mining, oil and gas and the offshore sectors.”

For the customer, receiving local maintenance support that is backed by the original equipment manufacturer (OEM) in terms of technical drawings and parts, ensures a fast response and a reliable service.

Corey Hansen, senior manager aftermarket business at Kato Engineering comments: “Sulzer has a global presence and a strong reputation for services of a variety of electromechanical products. Kato Engineering is actively looking to expand our service network to ensure strong global coverage and service support strategically located close to our product in the field. This Authorized Service Agreement with Sulzer has provided the opportunity to partner with an established company that has hands-on experience with our products. This Agreement will be complimentary to our Aftermarket Parts, Remanufacture, and Field Service capabilities that we have internally operating out of our three North American facilities.”

Sulzer’s relationships with OEMs such as Kato, Nidec ensure that customers receive the best possible service in terms of accessibility, speed and quality. With its own in-house, high voltage coil manufacturing facilities in Birmingham, UK and Brisbane, Australia, combined with its core engineering expertise, Sulzer has all the specialist skills required to meet OEM standards.

Jim Mugford, president and global head of Sulzer’s electromechanical services, concludes: “This further development with Kato generators reinforces the need for high-quality service and technical expertise in modern industrial applications. Our global service center network together with our extensive knowledge and experience will ensure that customers receive the highest standard of service.” (www.sulzer.com)

Timken

ACQUIRES DIAMOND CHAIN COMPANY

The Timken Company has acquired The Diamond Chain Company from Amsted Industries. Diamond Chain is a leading supplier of high-performance roller chains for industrial markets. The company serves a diverse range of sectors, including industrial distribution, material handling, food and beverage, agriculture, construction and other process industries. For the 12 months ended March 31, 2019, Diamond Chain posted sales of over \$60 million.

“The acquisition of The Diamond Chain Company adds another strong industrial brand with a reputation for quality, reliability and performance to Timken’s growing power transmission portfolio,” said Richard G. Kyle, Timken presi-



dent and chief executive officer. “Diamond Chain is a premier brand in the North American distribution channel and is an excellent strategic fit with our Drives chain business. The acquisition expands our leadership in roller chain, builds on our strong position in distribution and adds depth to our manufacturing capabilities in Asia. We expect to drive significant synergies with the combination of Diamond Chain and Drives.”

Founded in 1890 and headquartered in Indianapolis, Indiana, Diamond Chain has manufacturing operations in the United States and China. The company employs approximately 370 people.

With the acquisition of Diamond Chain, Timken’s power transmission portfolio now accounts for roughly one-third of Company revenues (reflects pro forma full-year revenues for acquisitions made within the past 12 months). Timken expects Diamond Chain results to be reported mostly through Timken’s Process Industries business segment. The acquisition was funded with cash on hand and through borrowings under existing credit facilities. Timken expects the acquisition to be accretive to adjusted earnings in 2019. (www.timken.com)

Posi Lock Puller

INTRODUCES NEW BRAND IDENTITY

The award-winning global manufacturer of gear and bearing pullers, Posi Lock Puller Inc. recently announced a new brand identity for its company and brands.

“Following the incredibly successful opening of the European warehouse and showroom, back in February, and our forthcoming expansion plans around the world — it was



an opportune time for us to introduce to the world our new graphic identity, reflecting our heritage of innovation dating back 40+ years,” said Tamara Somerville, CEO of Posi Lock Puller, Inc.

Posi Lock’s new brand identity includes a refreshed look and feel, including a beautiful new logo that reflects the core principles of the brand — strength, speed and safety. The new iconic imagery highlights the company’s patented “Safety Cage” design, through which Posi Lock has set the standard for safety, durability and simplicity of use for more than four decades. The company will unveil a new website soon.

In 1974, Dean Somerville, the founder of Posi Lock, was operating a machinery repair shop and a farming operation in the small North Dakota town of McHenry. With his inventive spirit and mechanical background, Somerville saw the need for a self-aligning, universal puller that could remove gears and bearings safely and quickly. His new puller design included a Safety Cage that would control the opening and closing of the pulling jaws, as well as provide the tool with clamping pressure. The new caged puller was patented in 1977 and given the name “Posi Lock Puller”, for its unparalleled clamping design. Till date, Posi Lock design and features remain the leader in its field.

“Our new brand identity is represented by a new logo celebrating the core product and heritage, bold color schemes and a new company presentation is a salute to Dean Somerville’s creation, our unique family-oriented corporate culture and a strong signal of the company’s bold new ambitions to grow globally,” said Somerville. (www.posilock.com)

AGMA

ANNOUNCES ADDITIVE MANUFACTURING PUBLICATION FOR GEAR MAKING

The American Gear Manufacturers Association (AGMA) announced the publication of an emerging technology document, Additive Manufacturing Technologies for Gears recently at the AGMA/ABMA Annual Meeting in Scottsdale, Arizona. This paper is part of the AGMA Emerging Technology Committee’s commitment to bring information on disruptive technologies to the AGMA membership. Kirk Rogers,



**American
Gear Manufacturers
Association**

Ph.D., Senior ADDvisorSM of The Barnes Group Advisors was brought on to author the paper with significant input from members of both the AGMA Emerging Technology Sub-Committees on 3D Metal Printing and New Materials.

“I’m excited that the committee had been able to oversee the generation of this paper as it fills a key need for AGMA members, obtaining an overall understanding of metal additive manufacturing and how it may affect gear manufacturing

directly. There are a lot of assumptions and misunderstandings in reference to metal AM,” said Justin Michaud, president, R.E.M. Surface Engineering and chair of the AGMA 3D Printing subcommittee, “This paper will help address these issues by providing enough information to complete a high to medium level evaluation of the technology without overwhelming the reader.”

The transition of the 3D printing technologies from legacy uses in rapid prototyping to true manufacturing is already taking place in the aerospace, defense and medical implant industries. The AGMA Emerging Technology Committee worked to provide a look at this technology with focus directly placed on gears. This paper discusses the seven different additive manufacturing technologies in metal printing, as defined by ASTM Committee F42, that are well-known for the ability to reduce the price of complex components, reduce the number of assembly parts in high-level assemblies, and to provide next generation performance by enabling complex designs.

- The paper discusses opportunities for the power transmission industry in additive manufacturing (AM):
- Manufacture complex geometries such as internal cooling or lubrication channels
- Reduce gear system inertia through the use of advanced designs that are difficult to manufacture conventionally
- Improve durability by the use of multiple optimized materials in a single part
- Change the cost of manufacturing by only placing material where it is needed
- Reduce product development time and time to market; and
- Improve safety, repeatability and assist humans with aids and tools.

The paper also discusses disruptive AM technologies that may impact power transmission. It highlights specifically, gear materials and additive manufacturing.

“This paper provides AGMA members with a snapshot of the current state of 3D printing metal and where it is beginning to intersect with the gear industry.” stated Mary Ellen Doran, AGMA director, Emerging Technology. “There is a lot of information out there on additive right now. But this paper is unique in that we worked to keep the focus on how this technology may directly be used to make gears. We hope that this is just a springboard for more activity by AGMA committees in this area.”

The paper, Additive Manufacturing Technologies for Gears, is currently available in the store on the AGMA website at www.agma.org. It is free for members and is available to non-members for \$99. (www.agma.org)

Stober Drives

RELEASES LATEST VERSION OF STOBER CONFIGURATOR

Stober has released the next version of Stober Fits with the Stober Configurator. This project has been in development for over 2.5 years and meets many of the requests our users had, such as on-demand CAD drawings.

With the new Stober Configurator, engineers and designers will save time in product selection and designing. Before the configurator, they searched through catalogs to find the right solution, request information in multiple places, and use type code values. Now, everything is a simple click away.

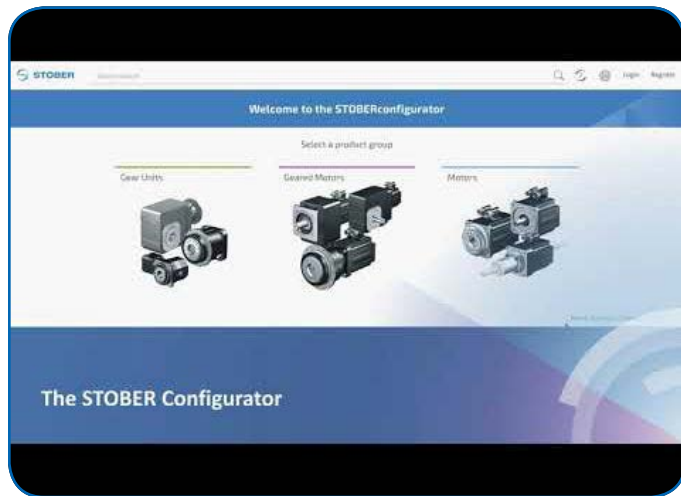

Quickly and easily search for gear units, geared motors, and motors. Intuitive navigation and modern design make using the tool fast and easy. Numerous filters and comparison options are available. Results can be sorted based on price, performance, or size. Users can then configure the product to meet their application requirements. For example, with geared motors, users can pick their shaft and housing style along with mounting position.

Designers can access technical data sheets, dimensional drawings, and 3D models. They can also request a quote. All configurations can be easily shared or saved. (*configurator.stober.com*)

Omron

DONATES DESIGN AND ROBOTICS LABORATORY TO UNIVERSITY OF HOUSTON

The University of Houston's Cullen College of Engineering recently unveiled a cutting-edge laboratory donated by the Omron Foundation, the charitable arm of automation solutions provider Omron in the United States. Designed for electrical and computer engineering students, the lab includes advanced technologies and equipment donated by Omron.

At the lab's opening ceremony, UH faculty and Omron representatives looked at a variety of senior capstone projects, including a sorting robot and a mobile robotic billboard. The lab contains an area dedicated to senior design projects, which provides real world design experience, which is helpful for gaining employment after graduation.

"Prospective employers will expect them to speak intelligently about what they worked on for their design project so the experience they gain at this stage is very important," says Len Trombetta, the associate department chair. "This makes our graduates very marketable because these are skills companies want. We're grateful to Omron for making this possible."



Omron Automation Americas President, CEO and COO Robb Black described the importance of preparing today's students for the latest challenges in engineering and manufacturing. "We want to bring the skills they have learned in school into the manufacturing sector," says Black. "I think it's a great way for students to learn real-world technology and apply it once they leave."

Omron Foundation has been supporting the Cullen College's electrical and computer engineering students since 2010, when it established the Omron Scholarship in electrical engineering and sponsored a team of students applying their engineering knowledge to real-world industry problems in the Capstone Design course. Omron also provides one-on-one mentoring to UH engineering students. (*www.omron.com*)

AD

ANNOUNCES COMPLETION OF IDI MERGER

AD, the member owned buying/marketing group, announced the completion of the merger with IDI Independent Distributors Inc., effective April 1, 2019. IDI is now AD Canada Industrial & Safety. Key merger highlights include bringing 103 independent industrial Canadian distributors with over 364 locations into the AD family; welcoming 21



new employees and a distribution center located in Mississauga, Ontario as part of the transaction; and AD Canadian members now representing 20% of AD consolidated sales. Rob Dewar, IDI president, is now the president of AD Canada Industrial & Safety. (www.adhq.com)

Motion Industries

NAMES SENIOR VICE PRESIDENT — SOUTHEAST GROUP

Motion Industries, Inc. has named **John Watwood** group senior vice president of the company's Southeast Group — effective May 1, 2019.

A graduate of University of North Alabama (MBA) and University of Alabama at Birmingham, (BS Industrial Distribution/Marketing), Watwood has over 20 years of experience in the industry. He has worked in various positions with AIT, Fluid Engineering and SMC before joining Motion Industries in 2008 as a fluid power specialist based out of Mississippi. Watwood quickly worked his way up to branch manager positions in Columbus, MS, and Nashville, TN, before earning a promotion to division vice president, general manager of the Nashville division in 2014.

Kevin Storer, Motion Industries executive vice president U.S. Operations, said, "John's experience, expertise, and leadership style are well-suited for this expanded role and will allow him to move with agility toward success. We are excited that he has accepted the challenge to grow our Southeast market and enhance our initiatives with a fresh perspective."

"John brings an intensity we need in the current market, along with the ability to drive strategic change through efficient operational execution. We look forward to seeing the Southeast Operating Group's future accomplishments resulting from his influence," said Randy Breaux, president at Motion Industries. (motionindustries.com)



Twin Disc

ANNOUNCES WISCONSIN EXPANSION

Twin Disc, Inc. is near completion of an expansion project in Wisconsin.

The 39,000 square-foot North American Aftermarket Distribution Center offers three times the capacity of the current location, and provides dedicated aftermarket resources and shipping flexibility. It is located at 2000 S. Sylvania Avenue, Sturtevant, Wisconsin, adjacent to the I-94 Corridor between Milwaukee and Chicago and is just six miles west of the Global Manufacturing Headquarters in Racine.

The state-of-the-art facility has increased capacity and storage racking, uses advanced equipment including a



Vertical Lift Module (VLM) for small components and applies lean strategies to create exceptional value for Twin Disc customers.

"The North American Aftermarket Distribution Center will be a much-needed hub for stocking and shipping all of our spare parts," said Jorge Colorado, director, aftersales and service of Twin Disc. "This added distribution space will improve and streamline our aftersales operations and provide a greater customer experience by increasing our efficiency."

The Center opened on May 14, 2019, with operations running at peak performance by June 3, 2019, the North American Aftermarket Distribution Center will allow Twin Disc to meet growing distribution and aftermarket demand. (www.twindisc.com)

Gilman Precision

ADDS TO BUSINESS DEVELOPMENT TEAM

Gilman Precision, manufacturer of customized linear and rotary motion systems, is delighted to announce the addition of **Matt Fritschel** to their sales force as a business development specialist.

Fritschel will oversee the Midwestern territory consisting of Wisconsin, Illinois, Minnesota, and Iowa. Within this role, he will generate clear lines of communication to foster positive relations between customers and Gilman engineers. Fritschel will also use his skills to address specific customer needs to develop the most efficient solution to their linear or rotary motion challenge.

Fritschel has 12 years of business-to-business sales experience, with 10 being in the manufacturing sector. His previous positions, including sales representative at Western States Envelope & Label and operations specialist at Direct Supply, have developed his detail oriented, customer-focused sales personality. He is regarded by his colleagues to be diligent in his work and to possess strong interpersonal skills. Fritschel is pleased to join the Gilman team "to help customers find correct, long-term solutions to their needs."

Doug Biggs, vice president of sales and marketing, commented: "We are very excited to have Matt join our business development team. We are certain his experience and abilities will prove beneficial in creating new opportunities and complementing Gilman's customer-minded mission." (www.gilmanprecision.com)



A wireframe wormhole structure is depicted against a dark space background with a prominent red nebula. The wormhole is a funnel shape that narrows in the middle. At the top opening of the wormhole, a full Earth is visible. At the bottom opening, another full Earth is visible. Several smaller, distant Earths are scattered in the background. The overall scene suggests a time-travel portal.

GREAT SCOTT!

It's the future!

OK, you blinked and missed last month's issue of *Power Transmission Engineering*. Fortunately, you don't need a DeLorean to travel back in time — just a computer and working fingers.

Hop online and visit www.powertransmission.com to view the entire magazine.

At the PTE Library, every issue is free for download.
All you have to do is go and get it

www.powertransmission.com

June 29–July 2—2019 EASA Convention

Las Vegas, Nevada. The Electrical Apparatus Service Association, Inc. (EASA) is an international trade organization of over 1,800 electromechanical sales and service firms in nearly 80 countries. Through its many engineering and educational programs, EASA provides members with a means of keeping up to date on materials, equipment, and state-of-the-art technology. The 2019 EASA Convention features insights from plant maintenance customers, emerging and disruptive technologies, marketplace trends on motor driven systems, and a range of technical sessions focusing on improving electromechanical equipment. Another feature of the EASA Convention is the three-day exposition featuring the industry's leading manufacturers showing the latest in electric motors, drives and controls, pumps, generators, and other electromechanical equipment. The exposition features an open-floor format for attendees to talk face-to-face with companies that serve the electrical apparatus industry. The theme this year is "Navigate the Future." For more information, visit www.easa.com.

July 10–11—Dritev 2019 Bonn, Germany. Increased CO₂ discussions, sustainable mobility and electrified drives: The automotive transmission world is changing. Why the understanding of the transmission changes, how it is to be understood as part of the overall powertrain and why cross-component know-how becomes more and more important are some of the subjects that will be discussed. Attendees can expect more than 1,500 developers, around 100 international exhibitors and 80 specialist lectures on one of the world's largest networking platforms for powertrain and transmission development. For more information, visit www.dritev.com.

July 23–24—8th WZL Gear Conference USA Westminster, Colorado. Attendees can expect a selection of presentations from the research portfolio of WZL including information on gear design, manufacturing, gear checking, and testing. Highlights include requirements for hard finishing, gear optimization, superfinishing, trends in gear production, Internet of production, gear hobbing, gear modifications and a workshop tour of Kapp/Niles in Boulder. For 50+ years the annual WZL Gear Conference in Aachen, Germany, has been the basis for the exchange of experiences and close cooperation between the members of the WZL Gear Research Circle. The WZL Gear Conference takes place for two days which are exclusively devoted to the latest research on gear design, manufacturing, and testing for the North American market. Register at www.kapp-niles.com/index.php?id=811&L=4.

August 6–8—CAR Management Briefing Seminars Grand Traverse Resort, Traverse City, Michigan. The Center for Automotive Research (CAR) MBS leads the industry in providing a context for auto industry stakeholders to discuss critical issues and emerging trends while fostering new industry relationships in daily networking sessions. Seminars include targeted sessions on manufacturing strategy, vehicle lightweighting, connected and automated vehicles, advanced powertrain, supply chain, sales forecasting, purchasing, talent and designing for technology, future factories, design optimization, the mobility ecosystem and more. CAR MBS 2019 will focus on the auto industry's commitment to change, across the spectrum of

technology, strategy, mobility, policy, and manufacturing issues. For more information, visit www.cargroup.org.

August 6–8—ABMA Essential Concepts of Bearing Technology

Oak Brook, Illinois. This course will give you an overview of the bearing industry as well as basic bearing types and applications. Knowledge of the key players, bearing types and terminology will ensure that everyone has a basic knowledge of the industry upon arrival. This course is specially designed for engineers and others with technical backgrounds that have limited exposure to bearings and need to adapt their technical training to bearings or seek an upgrade to their technical knowledge. The Essentials Course focuses on understanding basic tribology, bearing types and applications and explores the basic concepts around manufacturing methods, loads, lubrication and failure. For more information, visit www.americanbearings.org.

August 20–22—AGMA Detailed Gear Design Clearwater Beach, Florida. This class, taught by Raymond Drago of Drive System Technology, will provide gear engineers, gear designers and application engineers with: a basic introduction to gear theory and standardization; practical considerations and limitations associated with the application of standard AGMA/ISO durability rating analyses; investigation of the differences in stress states among the various surface durability failure modes, including pitting, spalling, case crushing and subcase fatigue; extended load capacity analysis techniques; consideration of friction in the calculation of surface compressive stresses; and much more. Register at www.agma.org.

September 11–12—Digital Industry USA 2019 Louisville, Kentucky. Digital Industry USA 2019 has partnered with leading industry associations to provide educational content for conference sessions and expert panels during the inaugural event. Leading industry association partners include, CSIA (Control System Integrators Association), ISA (International Society of Automation) and MESA (Manufacturing Enterprise Solutions Association) International. During the trade show's on-floor conference program, industry visionaries will showcase field experiences and case studies that feature real IIoT (Industrial Internet of Things) integration across their organizations. For more information, visit digitalindustry.com.

September 17–19—CTI Symposium China Shanghai, China. The next International CTI Symposium "Automotive Drivetrains, Intelligent & Electrified" will gather in China for the sixth time to exchange ideas on transmission technology developments. With lectures, presentations, keynote speeches and the satellite exhibition "Transmission Expo," the event will provide a powerful framework for high-ranking Chinese and international automobile and transmission manufacturers and suppliers. The focus will rest on strategies, new components and development tools for conventional and alternative drives. China is now by far the world's largest market for plug-in hybrid and electric vehicles. For more information, visit drivetrain-symposium.world/cn/registration/.

Power Transmission Engineering

Randall Publications LLC

1840 Jarvis Avenue
Elk Grove Village, IL 60007
Phone: (847) 437-6604
Fax: (847) 437-6618

EDITORIAL

Publisher & Editor-in-Chief

Michael Goldstein

publisher@powertransmission.com

Managing Editor & Associate Publisher

Randy Stott

wrs@powertransmission.com

Senior Editor

Jack McGuinn

jmcguinn@powertransmission.com

Senior Editor

Matthew Jaster

mjaster@powertransmission.com

Associate Editor

Alex Cannella

alex@geartechnology.com

Editorial Consultant

Paul R. Goldstein

ART

Art Director

David Ropinski

dropinski@powertransmission.com

ADVERTISING

Advertising Sales Manager

& Associate Publisher

Dave Friedman

dave@powertransmission.com

eMarketing Specialist

Matthew Stott

matthewstott@powertransmission.com

China Sales Agent

Eric Wu

Eastco Industry Co., Ltd.

Tel: (86)(21) 52305107

Fax: (86)(21) 52305106

Cell: (86) 13817160576

eric.wu@eastcotec.com

Materials Coordinator

Dorothy Fiandaca

dee@randallpublications.com

CIRCULATION

Circulation Manager

Carol Tratar

subscribe@powertransmission.com

Circulation Coordinator

Barbara Novak

bnovak@powertransmission.com

RANDALL PUBLICATIONS STAFF

President

Michael Goldstein

Accounting

Luann Harrod

ABB

Page 3

baldor.abb.com

AGMA

Page 11

MotionPowerExpo.com

Altra Industrial Motion

Page 2

www.nuttallgear.com/services/rebuild-services

www.delroyd.com/services/rebuild-services

B&R Machine and Gear

Page 38

www.brgear.com

Beyta Gear Service

Page 55

www.beytagear.com

Brother International

Inside Front Cover

www.brothergearmotors.com

Circle Gear

Page 31

www.circlegear.com

Cleveland Gear Co.

Page 39

www.clevelandgear.com

Continental

Page 33

continental-industry.com

CTI

Page 37

www.drivetrain-symposium.world/cn

Designatronics

Page 25

www.sdp-si.com

Diequa Corp.

Pages 14, 38, 39

www.diequa.com

Excel Gear

Page 21

www.excelgear.com

Forest City Gear

Page 17

www.forestcitygear.com

ITW Heartland

Page 35

SpiroidGearing.com

JIE USA

Page 38

www.jie-drives.com

Lafert North America

Page 32

www.lafertna.com

Lubriplate

Page 29

www.lubriplate.com

McInnes Rolled Rings

Page 24

www.mcinnesorledrings.com

Molon Motor and Coil

Page 26

www.molon.com

Motion+Power Technology Expo

Page 11

MotionPowerExpo.com

Napoleon Engineering Services

Page 16

www.nesbearings.com

NORD Drivesystems

Page 4

Benefits.myNORD.com

Nordex Inc.

Page 39

www.nordex.com

Philadelphia Gear

Page 27

PhilaGear.com/MyMission

Quicksilver Controls

Page 55

www.QuickSilverControls.com

R+W America

Page 7

www.rw-america.com

RBI Bearing Inc.

Page 5

www.rbibearing.com

Schaeffler Group

Back Outside Cover

www.schaeffler.us

SDP/SI

Page 25

www.sdp-si.com

SEW-Eurodrive

Inside Back Cover

www.seweurodrive.com

SMT

Page 15

masta.smartmt.com

U.S. Tsubaki Power Transmission

Page 23

ustsubaki.com

WD Bearings

Page 28

www.wd-bearings.com

WEG Electric Corp.

Page 13

www.weg.net

Worldwide Electric

Page 19

worldwideelectric.net

Zero-Max

Page 9

www.zero-max.com

YES I want to receive/continue to receive *Power Transmission Engineering*

NO Thanks anyway, but I don't need the world's best publication on mechanical components.

Name _____ Job Title _____
(please print)

Signature _____ Date _____
(required)

How would you like to receive *Power Transmission Engineering*?

- PRINT Version (Verify mailing info below)
- DIGITAL Version (E-mail required)
- BOTH Print AND Digital (E-mail required)

E-mail _____ *

How is THIS LOCATION involved with power transmission products? (Check all that apply)

- WE MAKE power transmission products
- WE BUY power transmission products
- WE SELL power transmission products (Distributors, sales reps, etc.)
- WE DESIGN products with power transmission components in them
- Other (please describe) _____

What is your company's principal product or service? _____

***Your PRIVACY is important to us. You get to CHOOSE how we use your personal information. The next e-mail we send you will have clear instructions.**

MAILING INFORMATION

NAME:

JOB TITLE:

COMPANY:

ADDRESS:

- Check if this is a home address

CITY:

STATE/Province:

ZIP/Postal Code:

PHONE:

FAX:

Put your business card here to make it easier!

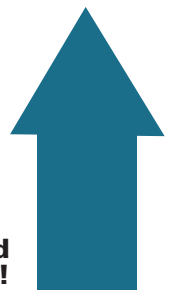

Mail to:
1840 Jarvis Ave., Elk Grove Village, IL 60007 USA

or

FAX to 1-847-437-6618
SCAN to: subscribe@powertransmission.com

Cars with Jet Engines

Joseph L. Hazelton, Contributing Editor

In the late 1940s, the U.S. auto industry started an exciting experiment and spent decades on it. One result came in '63, when the Turbine was introduced by Chrysler Corp., now a part of Fiat Chrysler Automobiles (FCA). In appearance, the two-door, four-passenger car looked like a regular car, but it wasn't. Under its sleek shell, the car had a jet engine.

The engine was the experiment, an effort to learn whether a jet engine—that is, a gas turbine—could be used as a car engine.

This experiment involved many cars and major technical problems, but it can be represented with just three cars. In '54, the car was a General Motors test vehicle, the XP-21 Firebird. It used a gas turbine, but it wasn't like a regular vehicle. The one-seater car looked like a jet plane on wheels.

That was OK, though. In a '54 brochure, GM explained it built the XP-21 “only for the proving ground and test track.”

By '56, GM had made strides with its turbine-powered car and introduced the XP-21's successor, the Firebird II. Back in the April issue, the Firebird II was featured as an early effort toward creating an autonomous vehicle. And it was that, but the car was also part of the jet engine experiment.

In the Firebird II, one major stride was: the car looked more like a regular car. In its brochure, the Firebird II was billed as “the gas turbine family car,” a four-seater, comfortable and effective for a family. It still looked a lot like an airplane, though.

Another major stride was the operation of the turbine engine. Actually, the engine consisted of two turbines: the gas turbine and a power turbine. In its XP-21 brochure, GM said the gas turbine “closely resembles a complete small jet engine.”

Reading the XP-21 brochure and the Firebird II brochure, you get a good explanation of how the turbines worked together.

At the front end of the gas turbine was its compressor, where air entered the car's engine. After the compressor, the air passed into the turbine's two combustion chambers and was heated by burning the car's fuel. Then, the hot gas was funneled through the turbine's back end.

In a jet plane, the gas would've been forced through a tailcone, creating the high-velocity thrust so the plane could fly. In the Firebirds, the gas was funneled toward the other turbine. The power turbine was designed like a windmill, it spun as the gas rushed by, and it was connected to the car's driveshaft, which sent power to the rear-wheel transmission.

In a car, though, a gas turbine presented problems. It burned a lot of fuel, lost a lot of heat, and made a lot of noise.

Those problems, encountered in the XP-21, were fixed in the Firebird II, and the solutions were discussed in the Firebird II brochure. The engine was changed so it would take heat from the exhaust gas and recirculate it back to the gas turbine's compressor. There, the heat combined with the cooler, incoming air, warming it part of the way to the engine's operating temperature. The engine then burned only enough fuel to bring the air the rest of the way up to that temperature.

As GM noted, the Firebird II's recirculating system recovered more than 80 percent of the heat in the exhaust gas, so the engine offered “fuel economy approaching that of present piston engines.”

The system also solved the heat problem. GM noted “that exhaust temperature is lowered as much as 1000

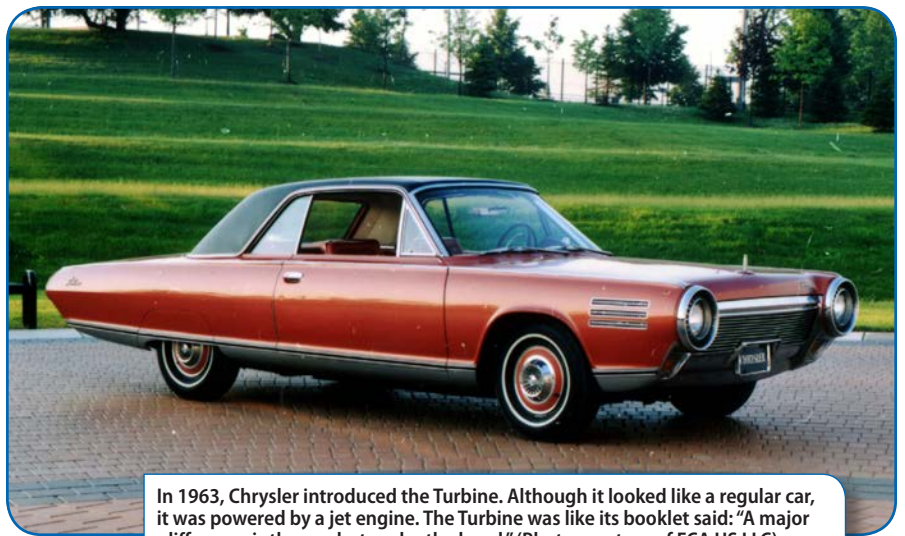

In 1963, Chrysler introduced the Turbine. Although it looked like a regular car, it was powered by a jet engine. The Turbine was like its booklet said: “A major difference is there—but under the hood.” (Photo courtesy of FCA US LLC)

degrees,” making the exhaust “pleasantly warm.”

GM fixed the noise problem by modifying the Firebird II's front end to include a “silencer” — GM's word — so “the car is as quiet as most automobiles of today.”

After the Turbine in '63, the jet engine experiment included other cars and continued for years. The three cars, though, suggest the auto industry's interest in the experiment. After all, it's no small thing to take a turbine-powered car from test-track experiment to production vehicle. The Turbine was only a limited production car, though. And eventually, the experiment ended.

Still, working on those cars must've been great for the auto engineers. Each day, they worked on a project that challenged their skills and fired their imaginations. Exciting days, no doubt. **PTE**



Stop paying twice!

Problem: Inefficient drive systems create heat. And, hundreds of drives = a ton of heat. So, you pay for energy twice - first to move the conveyor and second to cool the air. Time to switch gears . . .



Solution: MOVIGEAR® Mechatronic drive from SEW-EURODRIVE. It combines an IE4 motor, gearing, and advanced electronics into one highly efficient unit minus all of the heat. For proof, just ask design engineers about LAX Terminal 4 expansion.

SEW
EURODRIVE

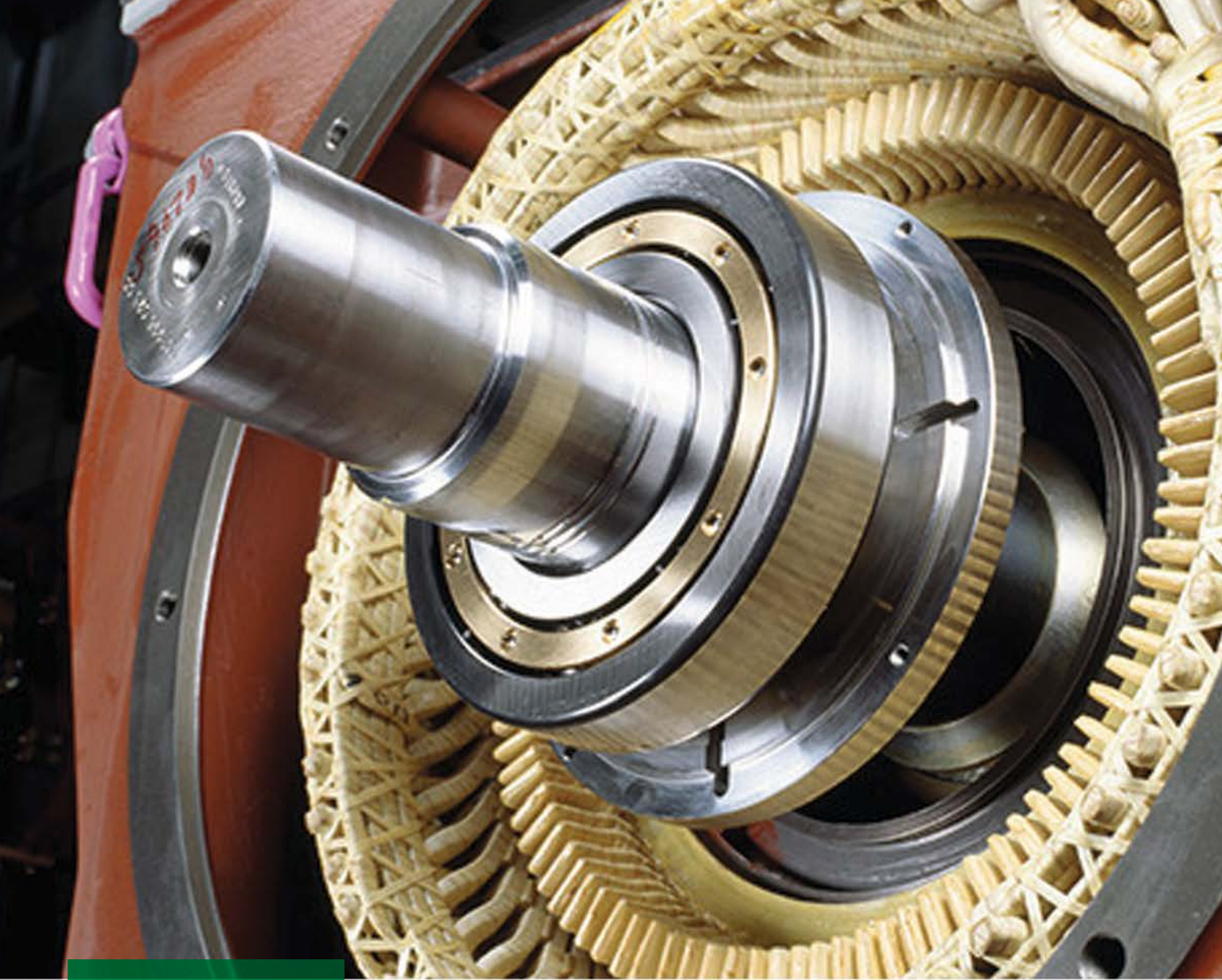

Stray Electric Current: Meet Your Match

The problem: Damage caused by electrical current passing through bearings in electric motors.

The solution: Current-insulated bearings from Schaeffler — including hybrid ceramic or ceramic-coated versions featuring our proprietary Insutect™ coating — that have been engineered to stop stray electric current in its tracks.

Now that's electrifying!

www.schaeffler.us

©2019



SCHAEFFLER